

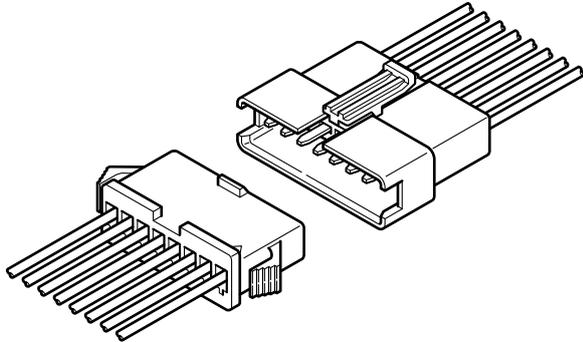

SM CONNECTOR

2.5 mm pitch/Disconnectable Crimp style wire-to-wire connectors



The SM series are 2.5 mm pitch, wire-to-wire connectors that perform reliably in high-density, small current applications.

- High contact pressure
- Highly reliable housing construction
- Mountable on a variety of panels
- Arm lock mechanism

Specifications

- Current rating: 3 A AC/DC max.
 - Voltage rating: 250 V AC/DC max.
 - Temperature range: -25°C to +85°C
(including temperature rise in applying electrical current)
 - Contact resistance: Initial value/ 10 mΩ max.
After environmental tests/ 20 mΩ max.
 - Insulation resistance: 500 MΩ min.
 - Withstanding voltage: 1,500 VAC/minute
 - Applicable wire: AWG #28 to #22
0.08 to 0.33 mm²
 - Applicable panel thickness: 0.5 to 2.0 mm
- * In using the products, refer to "Handling Precautions for Terminals and Connectors" described on our website (Technical documents of Product information page).
- * RoHS2 compliance
- * Dimensional unit: mm
- * Contact JST for details.

Standards

- Ⓜ Recognized E60389
- △ R50120150

Panel Layout and Assembly layout

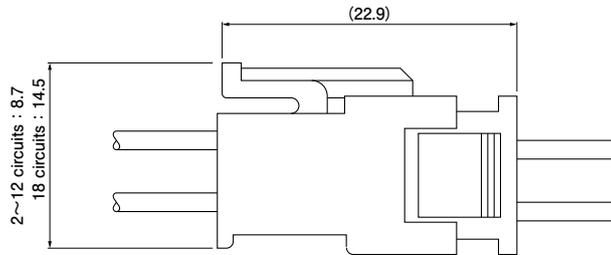

<2 to 12 circuits>

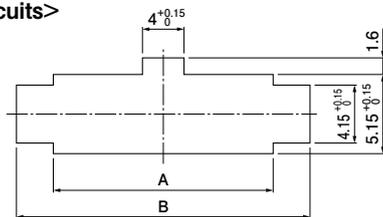

<18 circuits>

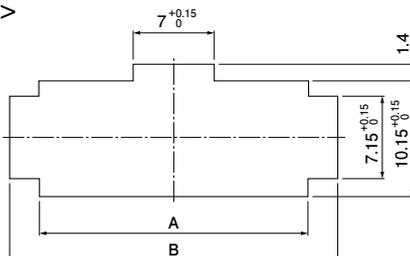

No. of circuits	Model No. Plug housing	Panel thickness (mm)					
		0.5~0.9		1.0~1.5		1.5~2.0	
		Panel hole dimensions (mm)		General tolerance			
		A ^{+0.15} ₀	B ^{±0.1}	A ^{+0.15} ₀	B ^{±0.1}	A ^{+0.15} ₀	B ^{±0.1}
2	SMP-02V-B(N)C	5.7	9.6	5.7	9.8	5.7	10.0
3	SMP-03V-B(N)C	8.2	12.1	8.2	12.3	8.2	12.5
4	SMP-04V-B(N)C	10.7	14.6	10.7	14.8	10.7	15.0
5	SMP-05V-B(N)C	13.2	17.1	13.2	17.3	13.2	17.5
6	SMP-06V-B(N)C	15.7	19.6	15.7	19.8	15.7	20.0
7	SMP-07V-B(N)C	18.2	22.1	18.2	22.3	18.2	22.5
8	SMP-08V-B(N)C	20.7	24.6	20.7	24.8	20.7	25.0
9	SMP-09V-B(N)C	23.2	27.1	23.2	27.3	23.2	27.5
10	SMP-10V-B(N)C	25.7	29.6	25.7	29.8	25.7	30.0
11	SMP-11V-B(N)C	28.2	32.1	28.2	32.3	28.2	32.5
12	SMP-12V-B(N)C	30.7	34.6	30.7	34.8	30.7	35.0
18	SMP-18V-B(N)C	23.2	27.2	23.2	27.4	23.2	27.6

- Note: 1. Punch holes in the panel according to the sketch and table shown above. Burrs must be removed.
 2. The strength of the panel must be considered when punching two or more holes.
 3. The connector must be inserted from the same side as the hole is punched.

SM CONNECTOR

Contact

Pin contact

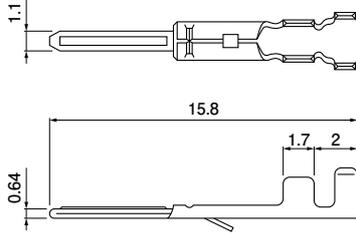

Socket contact

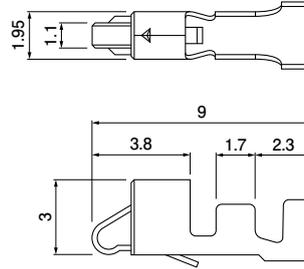

Model No.		Applicable wire		Insulation O.D. (mm)	Q'ty/reel
Pin contact	Socket contact	mm ²	AWG #		
SYM-001T-P0.6	SHF-001T-0.8BS	0.08~0.33	28~22	1.2~1.8	Pin contact: 8,500 Socket contact: 5,000

Material and Finish

Phosphor bronze, tin-plated (reflow treatment)

RoHS2 compliance

Note: 1. Contact JST for special products.
2. Contact JST for brass products.

Contact	Crimping machine	Applicator		
		Crimp applicator	Dies	Crimp applicator with dies
SYM-001T-P0.6	AP-K2N	MKS-L	MK/SYM-001-06	APLMK SYM001-06

Note: Contact JST for fully automatic crimping applicator.

Contact	Crimping machine	Applicator		
		Crimp applicator	Dies	Crimp applicator with dies
SHF-001T-0.8BS	AP-K2N	MKS-L	MK/SHF-001-08S	APLMK SHF001-08S

Note: Contact JST for fully automatic crimping applicator.

Contact position location numbers

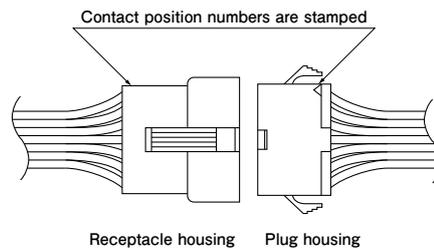

Receptacle housing																									
	<table border="0"> <tr><td>1</td><td></td></tr> <tr><td>2</td><td></td></tr> <tr><td>3</td><td></td></tr> <tr><td>4</td><td></td></tr> <tr><td>5</td><td></td></tr> <tr><td>6</td><td></td></tr> <tr><td>7</td><td></td></tr> <tr><td>8</td><td></td></tr> <tr><td>9</td><td></td></tr> <tr><td>10</td><td></td></tr> <tr><td>11</td><td></td></tr> <tr><td>12</td><td></td></tr> </table>	1		2		3		4		5		6		7		8		9		10		11		12	
1																									
2																									
3																									
4																									
5																									
6																									
7																									
8																									
9																									
10																									
11																									
12																									
	<table border="0"> <tr><td>10</td><td>1</td></tr> <tr><td>11</td><td>2</td></tr> <tr><td>12</td><td>3</td></tr> <tr><td>13</td><td>4</td></tr> <tr><td>14</td><td>5</td></tr> <tr><td>15</td><td>6</td></tr> <tr><td>16</td><td>7</td></tr> <tr><td>17</td><td>8</td></tr> <tr><td>18</td><td>9</td></tr> </table>	10	1	11	2	12	3	13	4	14	5	15	6	16	7	17	8	18	9						
10	1																								
11	2																								
12	3																								
13	4																								
14	5																								
15	6																								
16	7																								
17	8																								
18	9																								

Plug housing																									
	<table border="0"> <tr><td>1</td><td></td></tr> <tr><td>2</td><td></td></tr> <tr><td>3</td><td></td></tr> <tr><td>4</td><td></td></tr> <tr><td>5</td><td></td></tr> <tr><td>6</td><td></td></tr> <tr><td>7</td><td></td></tr> <tr><td>8</td><td></td></tr> <tr><td>9</td><td></td></tr> <tr><td>10</td><td></td></tr> <tr><td>11</td><td></td></tr> <tr><td>12</td><td></td></tr> </table>	1		2		3		4		5		6		7		8		9		10		11		12	
1																									
2																									
3																									
4																									
5																									
6																									
7																									
8																									
9																									
10																									
11																									
12																									
	<table border="0"> <tr><td>1</td><td>10</td></tr> <tr><td>2</td><td>11</td></tr> <tr><td>3</td><td>12</td></tr> <tr><td>4</td><td>13</td></tr> <tr><td>5</td><td>14</td></tr> <tr><td>6</td><td>15</td></tr> <tr><td>7</td><td>16</td></tr> <tr><td>8</td><td>17</td></tr> <tr><td>9</td><td>18</td></tr> </table>	1	10	2	11	3	12	4	13	5	14	6	15	7	16	8	17	9	18						
1	10																								
2	11																								
3	12																								
4	13																								
5	14																								
6	15																								
7	16																								
8	17																								
9	18																								

SM CONNECTOR

Housing

Material: PA 6, UL94V-0

No. of circuits	Current rating	Receptacle housing (for pin contact)		Plug housing (for socket contact)		
2	3 A	SMR-02V-B, black SMR-02V-N, white (natural)		Q'ty/ bag	SMP-02V-BC, black SMP-02V-NC, white (natural)	Q'ty/ bag
			1,000		1,000	
3	3 A	SMR-03V-B, black SMR-03V-N, white (natural)		Q'ty/ bag	SMP-03V-BC, black SMP-03V-NC, white (natural)	Q'ty/ bag
			1,000		1,000	
4	3 A	SMR-04V-B, black SMR-04V-N, white (natural)		Q'ty/ bag	SMP-04V-BC, black SMP-04V-NC, white (natural)	Q'ty/ bag
			500		1,000	
5	3 A	SMR-05V-B, black SMR-05V-N, white (natural)		Q'ty/ bag	SMP-05V-BC, black SMP-05V-NC, white (natural)	Q'ty/ bag
			500		1,000	
6	3 A	SMR-06V-B, black SMR-06V-N, white (natural)		Q'ty/ bag	SMP-06V-BC, black SMP-06V-NC, white (natural)	Q'ty/ bag
			500		500	

RoHS2 compliance

SM CONNECTOR

Housing

Material: PA 6, UL94V-0

No. of circuits	Current rating	Receptacle housing (for pin contact)		Plug housing (for socket contact)		
7	3 A	SMR-07V-B, black SMR-07V-N, white (natural)		Q'ty/ bag	SMP-07V-BC, black SMP-07V-NC, white (natural)	Q'ty/ bag
				500		
8	3 A	SMR-08V-B, black SMR-08V-N, white (natural)		Q'ty/ bag	SMP-08V-BC, black SMP-08V-NC, white (natural)	Q'ty/ bag
				500		
9	3 A	SMR-09V-B, black SMR-09V-N, white (natural)		Q'ty/ bag	SMP-09V-BC, black SMP-09V-NC, white (natural)	Q'ty/ bag
				500		
10	3 A	SMR-10V-B, black SMR-10V-N, white (natural)		Q'ty/ bag	SMP-10V-BC, black SMP-10V-NC, white (natural)	Q'ty/ bag
				200		
11	3 A	SMR-11V-B, black SMR-11V-N, white (natural)		Q'ty/ bag	SMP-11V-BC, black SMP-11V-NC, white (natural)	Q'ty/ bag
				200		

RoHS2 compliance

Housing

Material: PA 6, UL94V-0

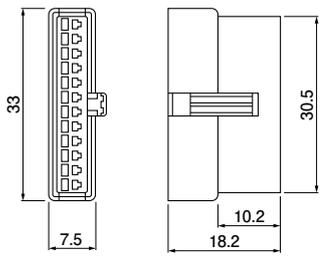
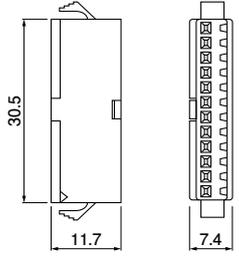
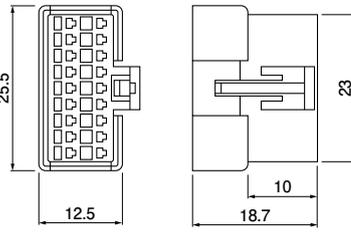
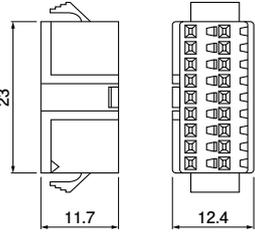
No. of circuits	Current rating	Receptacle housing (for pin contact)		Plug housing (for socket contact)			
12	3 A	SMR-12V-B, black SMR-12V-N, white (natural)		Q'ty/ bag	SMP-12V-BC, black SMP-12V-NC, white (natural)		Q'ty/ bag
18	2 A	SMR-18V-B, black SMR-18V-N, white (natural)		Q'ty/ bag	SMP-18V-BC, black SMP-18V-NC, white (natural)		Q'ty/ bag

RoHS2 compliance

Note: 1. SM connectors with any number of circuits can be used either panel mounted or free hanging.
 2. Contact JST for special products.

X-ON Electronics

Largest Supplier of Electrical and Electronic Components

Click to view similar products for [Headers & Wire Housings](#) category:

Click to view products by [JST](#) manufacturer:

Other Similar products are found below :

[95000-104TRLF](#) [10135584-644402LF](#) [DF62W-EP2022PCA](#) [95000-106TRLF](#) [DF62W-2022SCA](#) [DF62W-EP2022PC](#) [2203348](#) [DF62W-2022SC](#) [1084018](#) [1029039](#) [1084017](#) [802-10-012-10-002000](#) [1112640](#) [1112639](#) [891-007-9SS-BST1T](#) [000-34000](#) [0008550134](#) [0009482033](#) [0009507031](#) [57102-F02-18ULF](#) [57102-S06-03LF](#) [57202-S52-04LF](#) [PCN6-15S-2.5E](#) [0039019024](#) [58102-G61-06LF](#) [582553-1](#) [0009485154](#) [0009508121](#) [0022285053](#) [0050291907](#) [018731A](#) [LY20-4P-DT1-P1E-BR](#) [02.125.8002.8](#) [60101931](#) [60598-1 \(Cut Strip\)](#) [M1625-3R/100](#) [61062-3](#) [61082-181009](#) [CSU011177004](#) [636-1427](#) [638009-1](#) [641938-9](#) [641991-4](#) [644168-1](#) [644827-2](#) [647662-1](#) [65039-019ELF](#) [65692-001LF](#) [65781-018](#) [65781-047](#)