

VL CONNECTOR

6.2mm pitch/Disconnectable Crimp style connectors

(Combined use for both wire-to-board and wire-to-wire connections)

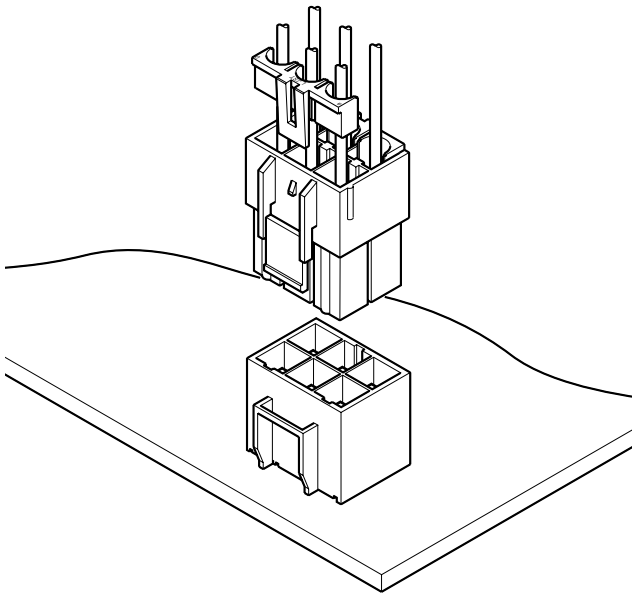

This VL connector is 6.2 mm pitch wire-to-wire and wire-to-board connector, designed for large current. Secondary retainer, which prevents from insufficient insertion of contact and coming off contact, may use and large current circuit can be connected certainly and safety.

- Housing lances
- Retainer
- Suited for large current
- Compatible for both wire-to-wire and wire-to-board connections

Specifications

- Current rating: 20 A AC, DC (Refer to the following table.)
- Voltage rating: 600 V AC, DC
- Temperature range: -25°C to +90°C
(including temperature rise in applying electrical current)
- Contact resistance: Initial value/ 7 mΩ max.
After environmental tests/ 10 mΩ max.
- Insulation resistance: 1,000 MΩ min.
- Withstanding voltage: 2,000 VAC/minute
- Applicable wire: AWG #22 to #12
- Applicable PC board thickness: 1.6 mm

* In using the products, refer to "Handling Precaution for Terminal and Connector" described on our website (Technical documents of Product information page).

* Contact JST for details.

* RoHS2 compliance

Note: The current rating differs depending on the number of circuits and the wire size used in each connector. The table below lists the current rating as a function of the number of circuits and the wire size.

| No. of circuits | Wire size (AWG) | | | | | |
|-----------------|-----------------|-----|-----|-----|-----|-----|
| | #12 | #14 | #16 | #18 | #20 | #22 |
| 2 | 20 | 15 | 10 | 8 | 6 | 4 |
| 3 | 17 | 14 | 9 | 8 | 6 | 4 |
| 4 | 16 | 13 | 9 | 7 | 6 | 4 |
| 6 | 15 | 12 | 8 | 7 | 5 | 3 |
| 8 | 14 | 11 | 7 | 6 | 5 | 3 |
| 12 | 13 | 10 | 7 | 6 | 4 | 3 |

Current unit: A

Note: Do not branch in parallel current which exceeds the rated current (e.g. more than 17A in the case of 3 circuits with AWG #12). If branched in parallel, current imbalance or other problems may develop. If it is absolutely necessary to branch such a large current in parallel, design the circuits without causing any imbalance and provide an extra margin for each circuit.

Standards

UL Recognized E60389

CS Certified LR20812

UL R9351103

PC board layout and Assembly layout

<2, 3, 4 (Single-row) circuits>

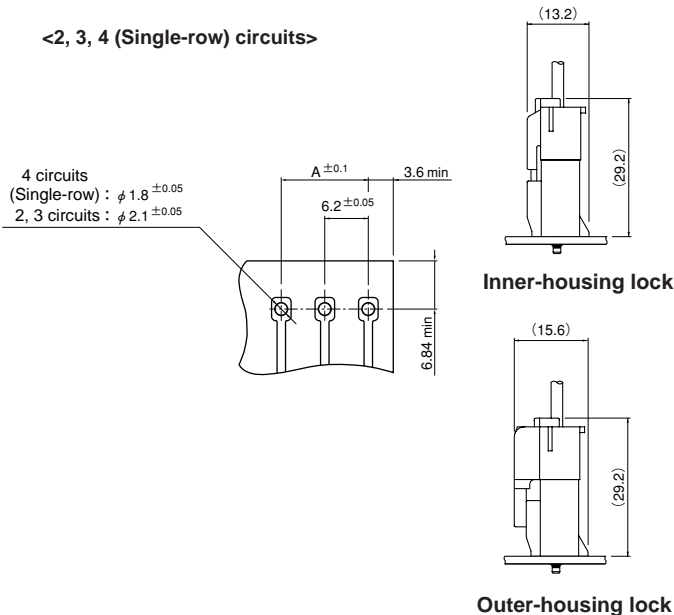

<4, 6, 8, 12 circuits>

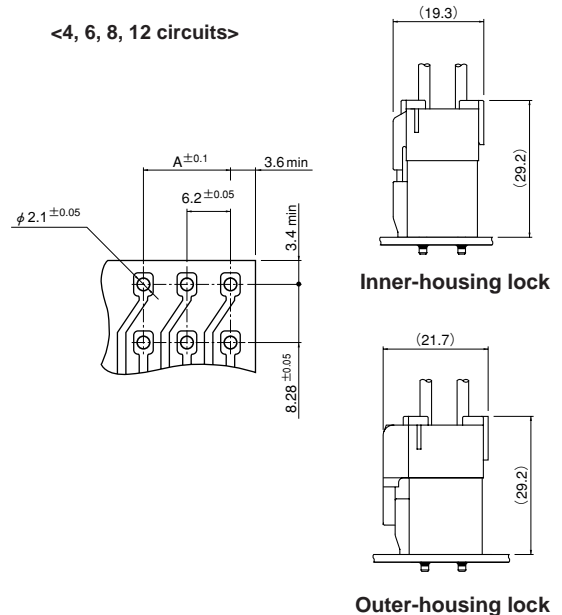

Note: 1. The above figure is the figure viewed from soldering side.

2. Tolerances are non-cumulative: ±0.05 mm for all centers.

3. Hole dimensions differ according to the type of PC board and piercing method. The dimensions above should serve as a guideline. Contact JST for details.

VL CONNECTOR

Contact

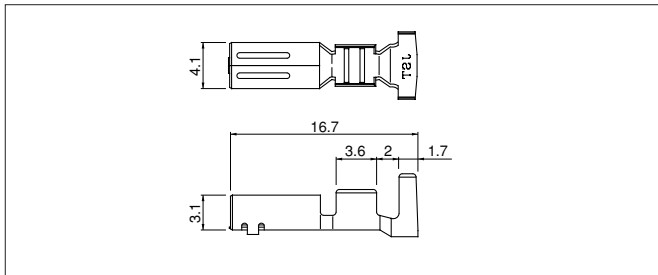

| Model No. | Applicable wire | | Insulation O.D. (mm) | Q'ty/reel |
|---------------------|-----------------|-------|----------------------|-----------|
| | mm ² | AWG # | | |
| SVF-42T-P2.0 | 0.3~1.25 | 22~16 | 1.7~3.2 | 2,000 |
| SVF-61T-P2.0 | 0.5~2.0 | 20~14 | 1.9~3.4 | 2,000 |
| SVF-81T-P2.0 | 3.5 | 12 | 4.1 | 2,000 |

Material and Finish

Phosphor bronze, tin-plated (reflow treatment)

RoHS2 compliance

| Contact | Crimping machine | Applicator | | |
|---------------------|------------------|------------------|----------------|----------------------------|
| | | Crimp applicator | Dies | Crimp applicator with dies |
| SVF-42T-P2.0 | AP-K2N | MKS-L | MK/SVF/M-42-20 | APLMK SVF/M42-20 |
| | | — | — | — |
| SVF-61T-P2.0 | AP-K2N | MKS-L | MK/SVF/M-61-20 | APLMK SVF/M61-20 |
| | | — | — | — |

| Contact | Crimping machine | Applicator | | |
|---------------------|------------------|------------------|----------------|----------------------------|
| | | Crimp applicator | Dies | Crimp applicator with dies |
| SVF-81T-P2.0 | AP-K2N | MKS-L | MK/SVF/M-81-20 | APLMK SVF/M81-20 |
| | | — | — | — |

Note: Contact JST for fully automatic crimping applicator.

Housing (Inner-housing lock)

<2 circuits>

<3 circuits>

<4 circuits>

<6 circuits>

<8 circuits>

<12 circuits>

| No. of circuits | Model No. | Q'ty/bag |
|-----------------|----------------|----------|
| 2 | VLP-02V | 500 |
| 3 | VLP-03V | 500 |
| 4 | VLP-04V | 500 |
| 6 | VLP-06V | 500 |
| 8 | VLP-08V | 200 |
| 12 | VLP-12V | 100 |

Material

PA 66, UL94V-0, natural (white)

RoHS2 compliance

Note: Contact JST for Glow Wire compliant connectors.

VL CONNECTOR

Housing (Outer-housing lock)



| No. of circuits | Model No. | Q'ty/bag |
|-----------------|------------|----------|
| 2 | VLP-02V-1 | 500 |
| 3 | VLP-03V-1 | 500 |
| 4 | VLP-04V-1 | 500 |
| 4 (Single-row) | VLP-04VN-1 | 500 |
| 6 | VLP-06V-1 | 500 |
| 8 | VLP-08V-1 | 500 |
| 12 | VLP-12V-1 | 500 |
| Material | | |

PA 66, UL94V-0, natural (white)

RoHS 2compliance

Note: Contact JST for Glow Wire compliant connectors.

VL CONNECTOR

Retainer

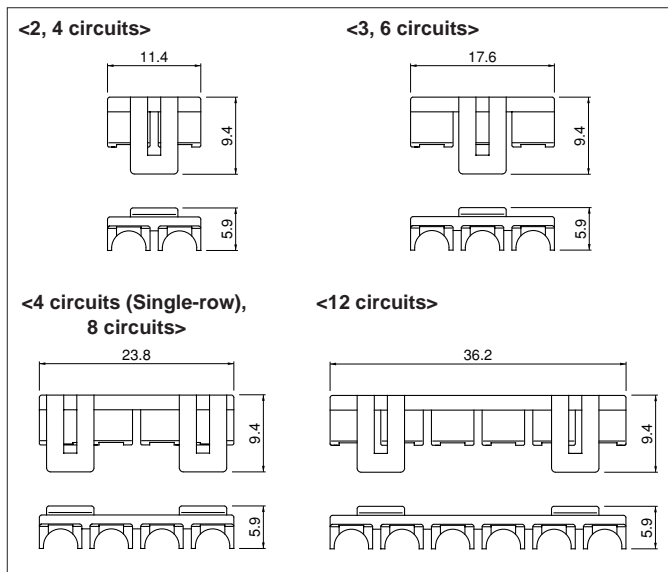

| No. of circuits | Model No. | Q'ty/bag |
|-------------------|----------------|----------|
| 2, 4 | VLS-02V | 1,000 |
| 3, 6 | VLS-03V | 1,000 |
| 4 (Single-row), 8 | VLS-08V | 1,000 |
| 12 | VLS-12V | 1,000 |

Material

Glass-filled PA 66, UL94V-0, natural (ivory)

RoHS2 compliance

Header

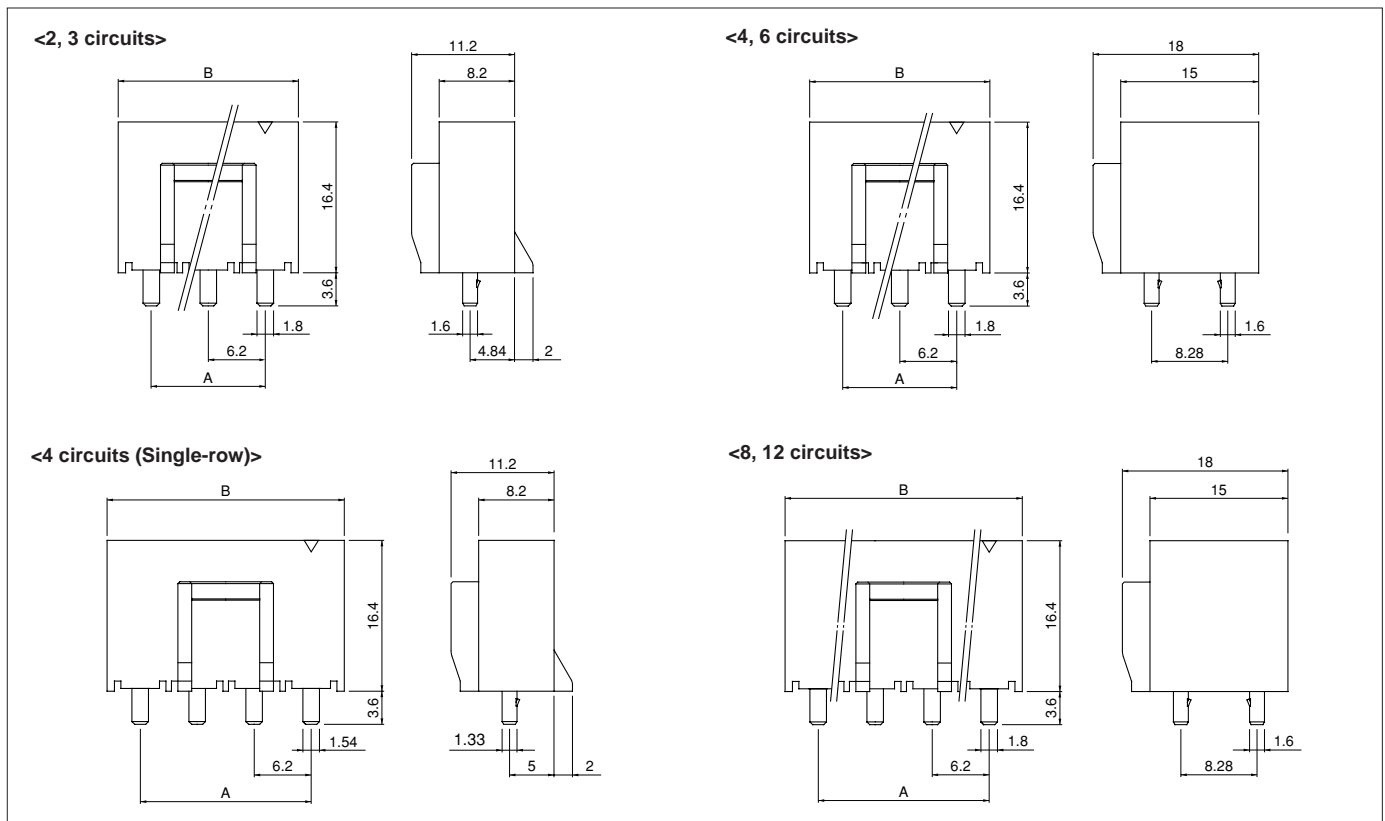

| No. of circuits | Model No. | Dimensions (mm) | | Q'ty/box |
|-----------------|-----------------------|-----------------|------|----------|
| | | A | B | |
| 2 | B02P-VL | 6.2 | 13.4 | 100 |
| 3 | B03P-VL | 12.4 | 19.6 | 100 |
| 4 | B04P-VL | 6.2 | 13.4 | 100 |
| 4 (Single-row) | B04P-VL-VN-1.8 | 18.6 | 26.2 | 100 |
| 6 | B06P-VL | 12.4 | 19.6 | 50 |
| 8 | B08P-VL | 18.6 | 26.2 | 50 |
| 12 | B12P-VL | 31.0 | 38.6 | 35 |

Material and Finish

Post: Copper-alloy, tin-plated (reflow treatment)

Wafer: PA 66, UL94V-0, natural (white)

RoHS 2 compliance

Note: Contact JST for Glow Wire compliant connectors.

Contact position location numbers

Inner-housing lock

<2 circuits>

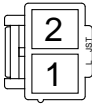

<3 circuits>



<4 circuits>

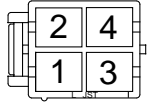

<6 circuits>

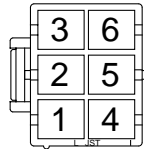

<8 circuits>

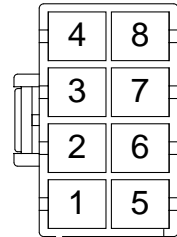

<12 circuits>

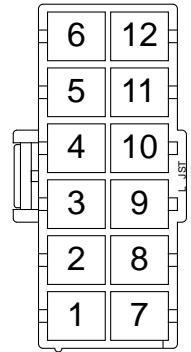

Outer-housing lock

<2 circuits>

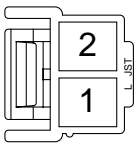

<3 circuits>

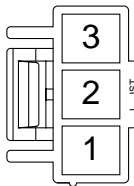

<4 circuits>

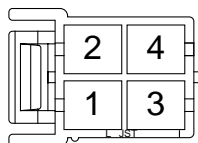

<4 circuits (Single-row)>

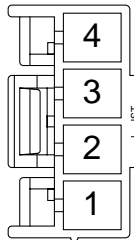

<6 circuits>

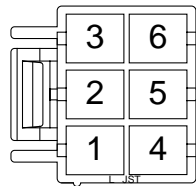

<8 circuits>

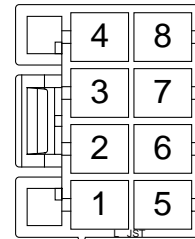

<12 circuits>

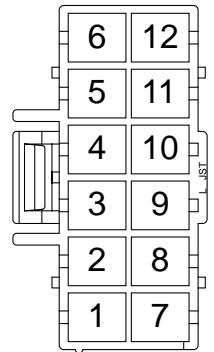

Model number identification

Connector

S V F - 42 T - P 2.0

Form: S --- Strip form, B --- Loose piece

Series name

Shape: F --- Socket contact

Applicable wire: 42 --- AWG #22 to #16

61 --- AWG #20 to #14

81 --- AWG #12

Surface finish: T --- Tin-plated (Reflow treatment)

Material: P --- Phosphor bronze

Terminal size

Housing

VL P - 02 V - 1

Series name

Part name: Plug

No. of circuits: 2, 3, 4, 6, 8, 12

Flammability: V --- UL94V-0

Shape: None --- Inner lock

1 --- Outer lock

Header

B 02P - VL

Assembly style: B --- Top entry type

No. of circuits: 2, 3, 4, 6, 8, 12

Series name

Retainer

VL S - 02 V

Series name

Part name: Retainer

No. of circuits: 2, 3, 4, 6, 8, 12

Flammability: V --- UL94V-0

X-ON Electronics

Largest Supplier of Electrical and Electronic Components

Click to view similar products for [Headers & Wire Housings](#) category:

Click to view products by [JST](#) manufacturer:

Other Similar products are found below :

[95000-104TRLF](#) [10135584-644402LF](#) [DF62W-EP2022PCA](#) [95000-106TRLF](#) [DF62W-2022SCA](#) [DF62W-EP2022PC](#) [2203348](#) [DF62W-2022SC](#) [1084018](#) [1029039](#) [1084017](#) [802-10-012-10-002000](#) [1112640](#) [1112639](#) [891-007-9SS-BST1T](#) [000-34000](#) [0008550134](#) [0009482033](#) [0009507031](#) [57102-F02-18ULF](#) [57102-S06-03LF](#) [57202-S52-04LF](#) [PCN6-15S-2.5E](#) [0039019024](#) [58102-G61-06LF](#) [582553-1](#) [0009485154](#) [0009508121](#) [0022285053](#) [0050291907](#) [018731A](#) [LY20-4P-DT1-P1E-BR](#) [02.125.8002.8](#) [60101931](#) [60598-1 \(Cut Strip\)](#) [M1625-3R/100](#) [61062-3](#) [61082-181009](#) [CSU011177004](#) [636-1427](#) [638009-1](#) [641938-9](#) [641991-4](#) [644168-1](#) [644827-2](#) [647662-1](#) [65039-019ELF](#) [65692-001LF](#) [65781-018](#) [65781-047](#)