

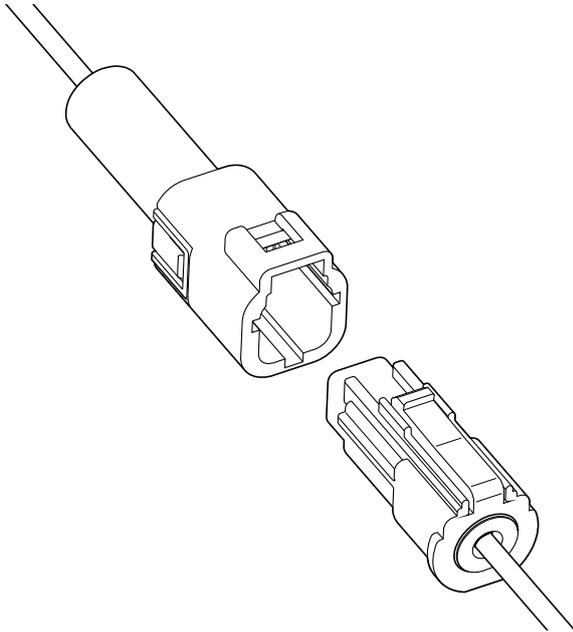

WPK CONNECTOR

Disconnectable Crimp style Wire-to-wire connectors (waterproof type)



This is wire-to-wire connector suitable for use in places where waterproof is especially required.

It is used for power connecting but compact, and has waterproof of grade 7 ingress protection of JIS C 0920 (IPX7 of IEC 60529) and excels in durability.

- Waterproof (ingress protection)
- Male housing has a built-in seal ring
- Compact design
- Inner-housing lock
- High durability and High reliability

Specifications

- Current rating: 7 A AC/DC (0.85 mm²)
- Voltage rating: 12 V AC/DC
- Temperature range: -40°C to +105°C
(including temperature rise in applying electrical current)
- Contact resistance: Initial value/ 5 mΩ max.
After environmental tests/ 10 mΩ max.
- Insulation resistance: 100 MΩ min.
- Withstanding voltage: 1,000 VAC/minute
- Applicable wire: 0.5 to 0.85 mm²
Insulation O.D./ 1.6 to 1.9 mm
- Waterproof grade: Grade 7 ingress protection of JIS C 0920 (IPX7 of IEC 60529)

* In using the products, refer to "Handling Precautions for Terminals and Connectors" described on our website (Technical documents of Product information page).

* RoHS2 compliance

* Dimensional unit: mm

* Contact JST for details.

Assembly layout

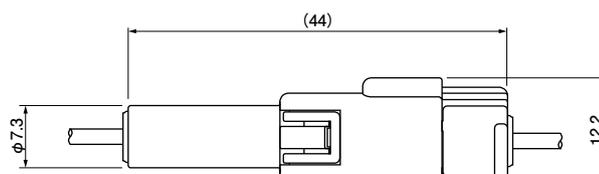

WPK CONNECTOR

Contact

Male contact

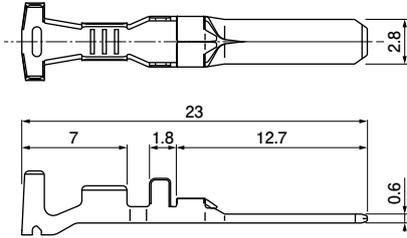

Female contact

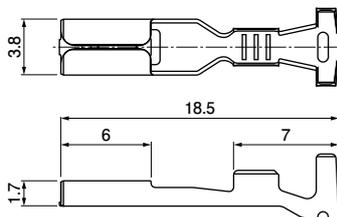

Model No.		Applicable wire (mm ²)	Insulation O.D. (mm)	Q'ty/ reel
Male contact	Female contact			
SWPKP-21T-0.6	SWPKR-21T-0.6	0.5~0.85	1.6~1.9	3,000

Material and Finish

Copper alloy, tin-plated (reflow treatment)

RoHS2 compliance

Contact	Crimping machine	Applicator		
		Crimp applicator	Dies	Crimp applicator with dies
SWPKP-21T-0.6	AP-K2N	MKS-L	MK/SWPKP/R-21-06	APLMK SWPKP/R21-06
SWPKR-21T-0.6				

Note: Contact JST for fully automatic crimping applicator.

Male housing (for male contact)

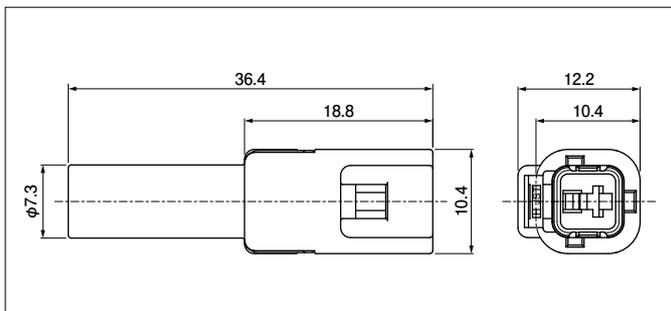

No. of circuits	Model No.	Q'ty/box
1	01P-WPKH-KN	100

Material and Finish

Housing: PBT, black
Seal ring: NBR, brown

RoHS2 compliance

Note: 01P-WPKH-KN has a built-in seal ring.

Female housing (for female contact)

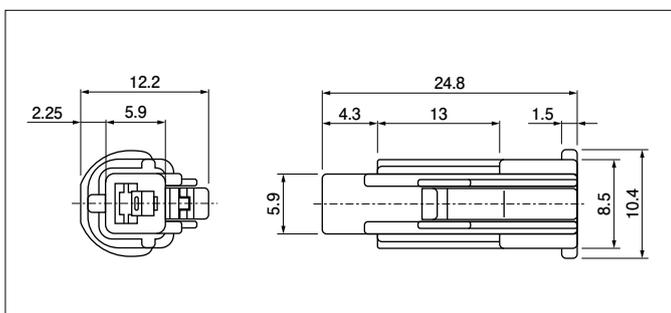

No. of circuits	Model No.	Q'ty/box
1	WPKR-01H-K	1,000

Material and Finish

PBT, black

RoHS2 compliance

Wire end seal

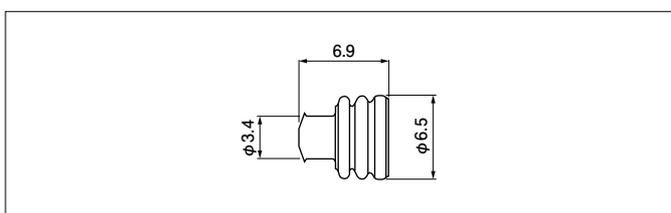

Model No.	Rubber inner diameter (mm)	Insulation O.D. (mm)	Q'ty/bag
WPKS-1.3N	1.3	1.6~1.9	1,500

Material and Finish

NBR, brown

RoHS2 compliance

Note: Contact JST for applicable wires.

X-ON Electronics

Largest Supplier of Electrical and Electronic Components

Click to view similar products for [Headers & Wire Housings](#) category:

Click to view products by [JST](#) manufacturer:

Other Similar products are found below :

[0015917161](#) [0022155065](#) [57102-F02-18ULF](#) [58102-G61-06LF](#) [582553-1](#) [01.001.5753.1](#) [0050291907](#) [02.125.8002.8](#) [609-3404](#) [61062-3](#)
[CSU011177004](#) [622-0430](#) [622-3653LF](#) [63453-116](#) [636-1030](#) [636-1427](#) [636-3427](#) [636-4007](#) [641938-9](#) [65495-038](#) [65692-001LF](#) [65781-018](#)
[65781-047](#) [65817-010LF](#) [65817-015LF](#) [67095-007LF](#) [67601157](#) [68631-112](#) [68645-018](#) [699319-000](#) [70.362.1628.0](#) [70-4210](#) [70-4226B](#) [70-](#)
[4853B](#) [71.350.2428.0](#) [733-134](#) [733-162](#) [MHR-64-VUAL](#) [80.063.4001.1](#) [800-90-001-10-001000](#) [801-43-002-10-013000](#) [801-43-006-10-](#)
[002000](#) [803-43-024-10-001000](#) [803-93-012-10-001000](#) [8-1437020-4](#) [819-22-004-30-001101](#) [820-22-006-30-001101](#) [820-22-008-30-001101](#)
[821-22-002-10-001101](#) [821-22-003-10-002101](#)