

XAD CONNECTOR

2.5mm pitch/Disconnectable Crimp style wire-to-wire connectors

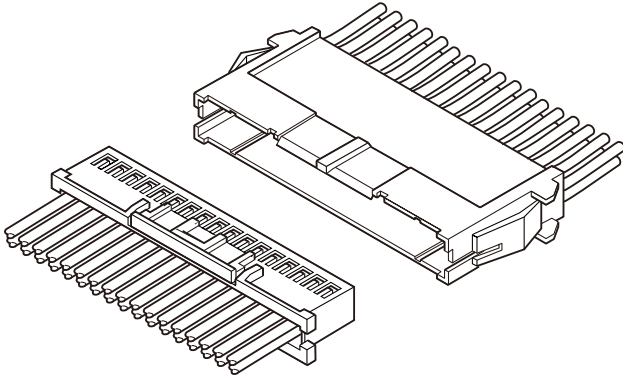

2.5mm pitch grid (dual in row) wire-to-wire connector that can mate with the socket of XAD connector (board-to-wire type).

- Possible to mate with the existing XAD socket
- Inner type contact lance
- Mountable on a variety of panels
- Secure lock construction

Specifications

- Current rating: 3A AC, DC max. (AWG #20)
- Voltage rating: 250V AC, DC max.
- Temperature range: -25°C to +85°C
(including temperature rise in applying electrical current)
- Contact resistance: Initial value/10m Ω max.
After environmental testing/20m Ω max.
- Insulation resistance: 500M Ω min.
- Withstanding voltage: 1,500V AC/minute
- Applicable wire: AWG #28 to #20
- * Compliant with RoHS.
- * Refer to "General Instruction and Notice when using Terminals and Connectors" at the end of this catalog.
- * Contact JST for details.

Standards

- Ⓜ Recognized E60389
- Ⓢ Certified LR20812
- ⚠ R9851219

Panel layout and Assembly layout

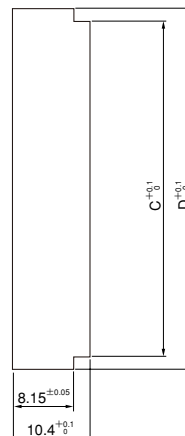
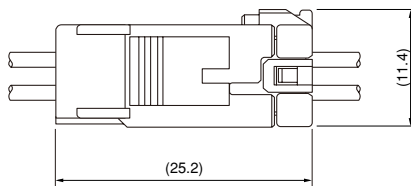

Note: C and D dimensions: Refer to receptacle housing.

XAD CONNECTOR

Contact

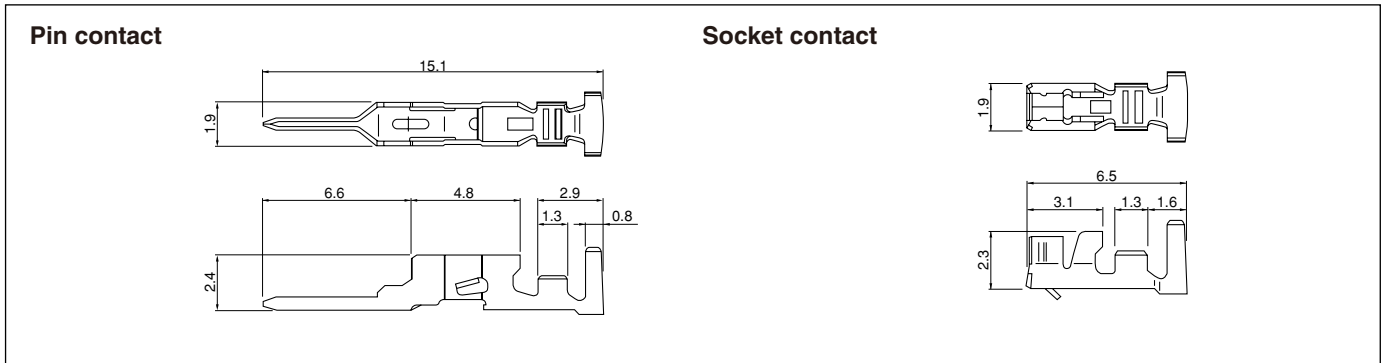

Model No.		Applicable wire		Insulation O.D.(mm)	Q'ty / reel	
Pin contact	Socket contact	mm ²	AWG #		Pin contact	Socket contact
SXAM-001T-P0.6	SXA-001T-P0.6	0.08~0.33	28~22	0.8~1.9	7,000	8,000
SXAM-01T-P0.6	SXA-01T-P0.6	0.22~0.5	24~20	1.5~1.9	7,000	8,000
—	SXA-001T-P0.6L	0.13~0.33	26~22	1.3~1.7	—	8,000

Material and Finish

Phosphor bronze, tin-plated (reflow treatment)

RoHS compliance

Note: Contact JST for gold-plated products.

Contact	Crimping machine	Applicator		
		Crimp applicator	Dies	Crimp applicator with dies
SXA-001T-P0.6	AP-K2N	MKS-L	MK/SXAM/XA-001-06	APLMK SXAM/XA001-06
		*MKS-SC	SC/SXAM/XA-001-06	APLSC SXAM/XA001-06
SXA-01T-P0.6		MKS-L	MK/SXAM/XA-01-06	APLMK SXAM/XA01-06
		*MKS-SC	SC/SXAM/XA-01-06	APLSC SXAM/XA01-06
SXA-001T-P0.6L	MKS-L	MK/SXA-001-06L	APLMK SXA001-06L	
	*MKS-SC	SC/SXA-001-06L	APLSC SXA001-06L	

Contact	Crimping machine	Applicator		
		Crimp applicator	Dies	Crimp applicator with dies
SXAM-001T-P0.6	AP-K2N	MKS-L	MK/SXAM/XA-001-06	APLMK SXAM/XA001-06
		*MKS-SC	SC/SXAM/XA-001-06	APLSC SXAM/XA001-06
SXAM-01T-P0.6		MKS-L	MK/SXAM/XA-01-06	APLMK SXAM/XA01-06
		*MKS-SC	SC/SXAM/XA-01-06	APLSC SXAM/XA01-06

Note: *Strip-crimp applicator

Receptacle housing (for pin contact)

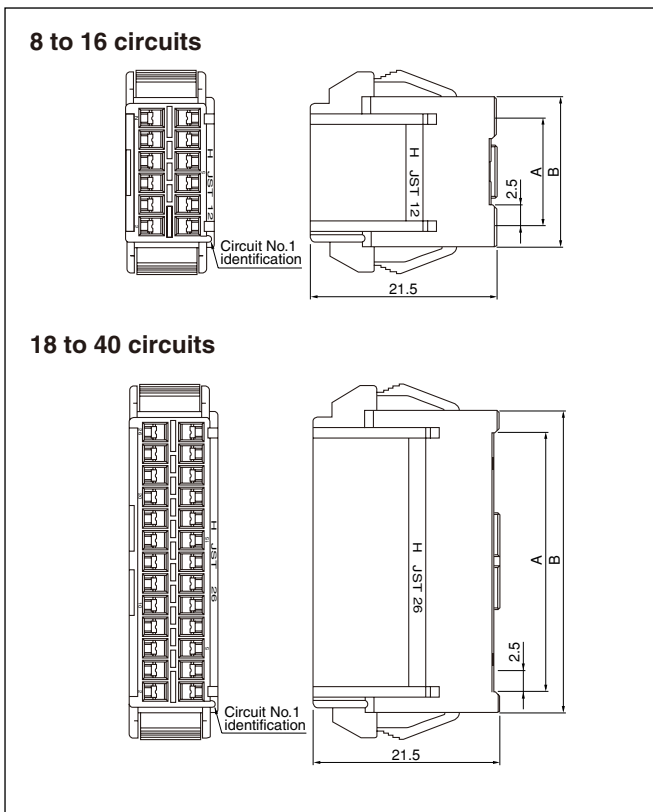

Circuits	Model No.	Dimensions (mm)				Q'ty / bag
		A	B	C	D	
8	XADR-08V	7.5	12.5	12.9	16.2	1,000
10	XADR-10V	10.0	15.0	15.4	18.7	500
12	XADR-12V	12.5	17.5	17.9	21.2	500
14	XADR-14V	15.0	20.0	20.4	23.7	500
16	XADR-16V	17.5	22.5	22.9	26.2	300
18	XADR-18V	20.0	25.0	25.4	28.7	300
20	XADR-20V	22.5	27.5	27.9	31.2	300
22	XADR-22V	25.0	30.0	30.4	33.7	300
24	XADR-24V	27.5	32.5	32.9	36.2	300
26	XADR-26V	30.0	35.0	35.4	38.7	300
28	XADR-28V	32.5	37.5	37.9	41.2	300
30	XADR-30V	35.0	40.0	40.4	43.7	300
32	XADR-32V	37.5	42.5	42.9	46.2	300
34	XADR-34V	40.0	45.0	45.4	48.7	200
36	XADR-36V	42.5	47.5	47.9	51.2	200
40	XADR-40V	47.5	52.5	52.9	56.2	200

Material

PA 66, UL94V-0, natural (white)

RoHS compliance

Note: C and D dimensions: Panel layout dimensions

XAD CONNECTOR

Plug housing (for socket contact)

8 to 16 circuits

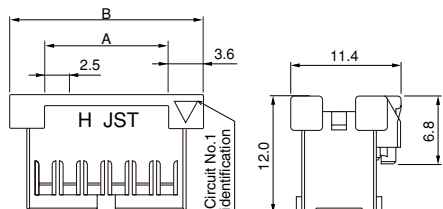

18 to 40 circuits

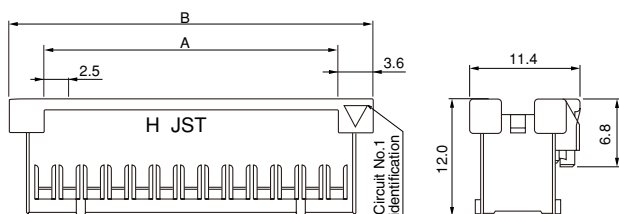

Circuits	Model No.	Dimensions (mm)		Q'ty / bag
		A	B	
8	XADRP-08V	7.5	14.7	1,000
10	XADRP-10V	10.0	17.2	1,000
12	XADRP-12V	12.5	19.7	1,000
14	XADRP-14V	15.0	22.2	1,000
16	XADRP-16V	17.5	24.7	1,000
18	XADRP-18V	20.0	27.2	1,000
20	XADRP-20V	22.5	29.7	500
22	XADRP-22V	25.0	32.2	500
24	XADRP-24V	27.5	34.7	500
26	XADRP-26V	30.0	37.2	500
28	XADRP-28V	32.5	39.7	500
30	XADRP-30V	35.0	42.2	500
32	XADRP-32V	37.5	44.7	500
34	XADRP-34V	40.0	47.2	500
36	XADRP-36V	42.5	49.7	500
40	XADRP-40V	47.5	54.7	250

Material

PA 66, UL94V-0, natural (white)

RoHS compliance

X-ON Electronics

Largest Supplier of Electrical and Electronic Components

Click to view similar products for [Headers & Wire Housings](#) category:

Click to view products by [JST](#) manufacturer:

Other Similar products are found below :

[57102-F02-18ULF](#) [58102-G61-06LF](#) [0009485154](#) [009176003701906](#) [0050291907](#) [02.125.8002.8](#) [609-3404](#) [61062-3](#) [622-0430](#) [622-3653LF](#)
[63453-116](#) [636-1030](#) [636-1427](#) [636-3427](#) [636-4007](#) [641938-9](#) [644827-2](#) [65495-038](#) [65692-001LF](#) [65781-018](#) [65781-047](#) [65817-010LF](#)
[65817-015LF](#) [66207-023LF](#) [67016-026LF](#) [67095-007LF](#) [68631-112](#) [68645-018](#) [68648-049](#) [699319-000](#) [70.362.1628.0](#) [70-4210](#) [70-4226B](#)
[70-4853B](#) [707-5020](#) [707-5028](#) [71.350.2428.0](#) [71961-016LF](#) [733-134](#) [754199-000](#) [760-3052](#) [787-8014-00](#) [FCN-367T-T012/H](#) [80.063.4001.1](#)
[800-90-001-10-001000](#) [800-90-010-10-002000](#) [801-43-002-10-013000](#) [801-43-006-10-002000](#) [803-41-018-10-001000](#) [803-43-014-20-](#)
[001000](#)