

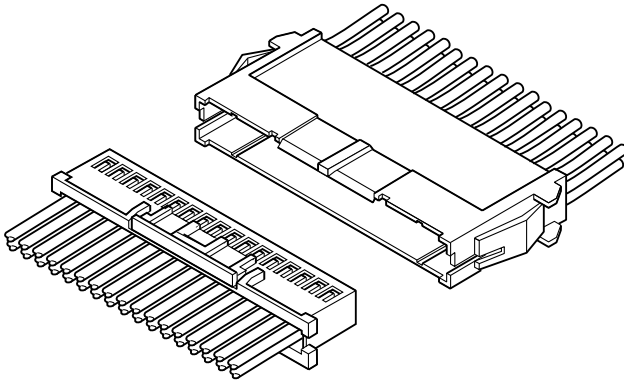

XAD CONNECTOR

2.5 mm pitch/Disconnectable Crimp style wire-to-wire connectors



This is dual-row panel mountable wire-to-wire connector for the XAD connector for printed circuit board (wire side).

- Compatible with XAD connector for printed circuit board (wire side)
- Inner type contact lance
- Panel mountable
- Secure locking structure

Specifications

- Current rating: 3 A AC/DC (AWG #20)
- Voltage rating: 250 V AC/DC
- Temperature range: -25°C to +85°C
(including temperature rise in applying electrical current)
- Contact resistance: Initial value/ 10 mΩ max.
After environmental tests/ 20 mΩ max.
- Insulation resistance: 500 MΩ min.
- Withstanding voltage: 1,500 VAC/minute
- Applicable wire: AWG #28 to #20

* In using the products, refer to "Handling Precautions for Terminals and Connectors" described on our website (Technical documents of Product information page).

* RoHS2 compliance

* Dimensional unit: mm

* Contact JST for details.

Standards

Ⓜ Recognized E60389

Ⓢ Certified LR20812

⚠ R9851219

Assembly layout and Panel layout

- Receptacle housing incompatible with retainer

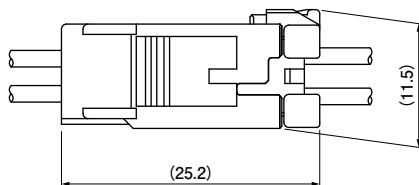

- Receptacle housing compatible with retainer

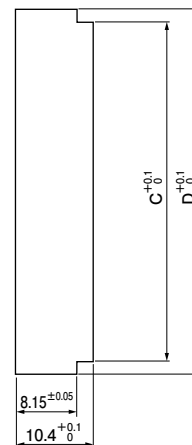
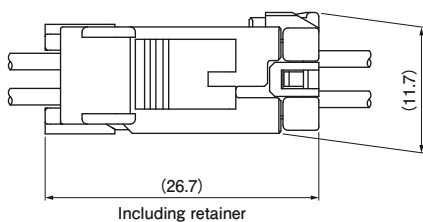

Note: C and D dimensions: Refer to the page of receptacle housing.

XAD CONNECTOR

Contact

Pin contact

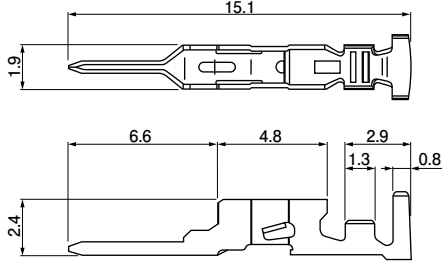

Socket contact

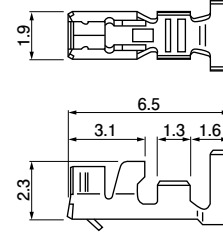

Model No.		Applicable wire		Insulation O.D. (mm)	Q'ty/reel	
Pin contact	Socket contact	mm ²	AWG #		Pin contact	Socket contact
SXAM-001T-P0.6	SXA-001T-P0.6	0.08~0.33	28~22	0.8~1.9	7,000	8,000
SXAM-01T-P0.6	SXA-01T-P0.6	0.22~0.5	24~20	1.5~1.9	7,000	8,000
—	SXA-001T-P0.6L	0.13~0.33	26~22	1.3~1.7	—	8,000

Material and Finish

Phosphor bronze, tin-plated (reflow treatment)

RoHS2 compliance

Note: Contact JST for gold-plated products.

Contact	Crimping machine	Applicator		
		Crimp applicator	Dies	Crimp applicator with dies
SXAM-001T-P0.6	AP-K2N	MKS-L	MK/SXAM/XA-001-06	APLMK SXAM/XA001-06
SXAM-01T-P0.6			MK/SXAM/XA-01-06	APLMK SXAM/XA01-06

Note: Contact JST for fully automatic crimping applicator.

Contact	Crimping machine	Applicator		
		Crimp applicator	Dies	Crimp applicator with dies
SXA-001T-P0.6	AP-K2N	MKS-L	MK/SXAM/XA-001-06	APLMK SXAM/XA001-06
SXA-01T-P0.6			MK/SXAM/XA-01-06	APLMK SXAM/XA01-06
SXA-001T-P0.6L			MK/SXA-001-06L	APLMK SXA001-06L

Note: Contact JST for fully automatic crimping applicator.

Receptacle housing (for pin contact)

• Receptacle housing incompatible with retainer (8 to 16 circuits)

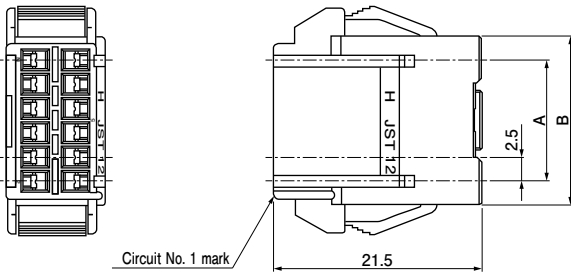

(18 to 40 circuits)

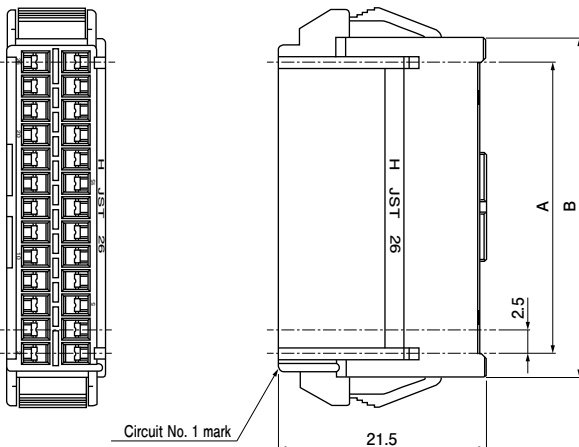

No. of circuits	Model No.	Dimensions (mm)				Q'ty/bag
		A	B	C	D	
8	XADR-08V	7.5	12.5	12.9	16.2	1,000
10	XADR-10V	10.0	15.0	15.4	18.7	500
12	XADR-12V	12.5	17.5	17.9	21.2	500
14	XADR-14V	15.0	20.0	20.4	23.7	500
16	XADR-16V	17.5	22.5	22.9	26.2	300
18	XADR-18V	20.0	25.0	25.4	28.7	300
20	XADR-20V	22.5	27.5	27.9	31.2	300
22	XADR-22V	25.0	30.0	30.4	33.7	300
24	XADR-24V	27.5	32.5	32.9	36.2	300
26	XADR-26V	30.0	35.0	35.4	38.7	300
28	XADR-28V	32.5	37.5	37.9	41.2	300
30	XADR-30V	35.0	40.0	40.4	43.7	300
32	XADR-32V	37.5	42.5	42.9	46.2	300
34	XADR-34V	40.0	45.0	45.4	48.7	200
36	XADR-36V	42.5	47.5	47.9	51.2	200
40	XADR-40V	47.5	52.5	52.9	56.2	200

Material and Finish

PA 66, UL94V-0, natural (white)

RoHS2 compliance

Note: C and D dimensions: Panel layout dimensions

Receptacle housing (for pin contact)

• Receptacle housing compatible with retainer (8 to 16 circuits)

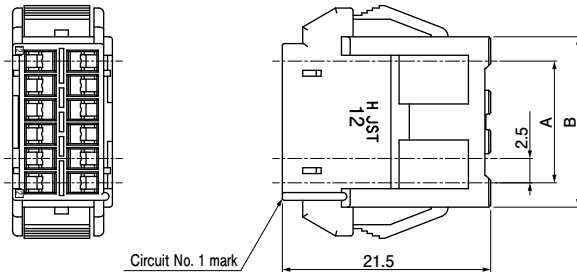

(18 to 24 circuits)

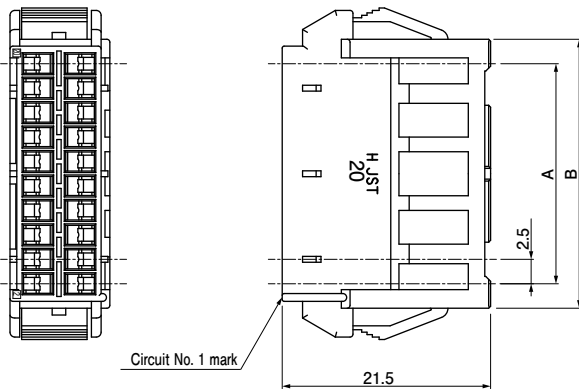

No. of circuits	Model No.	Dimensions (mm)				Q'ty/bag
		A	B	C	D	
8	XADRR-08V	7.5	12.5	12.9	16.2	1,000
10	XADRR-10V	10.0	15.0	15.4	18.7	500
12	XADRR-12V	12.5	17.5	17.9	21.2	500
16	XADRR-16V	17.5	22.5	22.9	26.2	300
18	XADRR-18V	20.0	25.0	25.4	28.7	300
20	XADRR-20V	22.5	27.5	27.9	31.2	300
22	XADRR-22V	25.0	30.0	30.4	33.7	300
24	XADRR-24V	27.5	32.5	32.9	36.2	300

Material and Finish

PA 66, UL94V-0, natural (white)

RoHS2 compliance

Note1: C and D dimensions: Panel layout dimensions
2: Unlisted in UL/CSA/TÜV.

Plug housing (for socket contact)

(8 to 16 circuits)

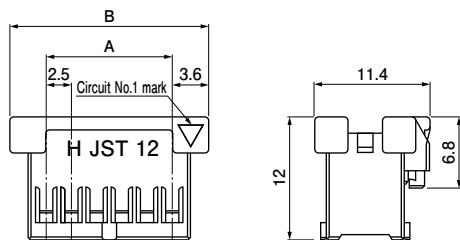

(18 to 40 circuits)

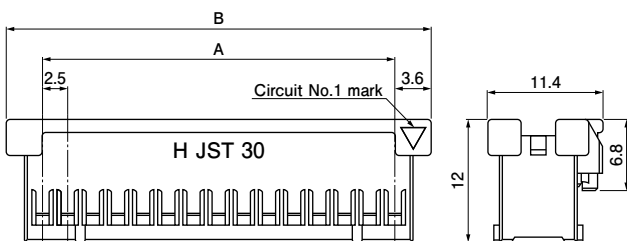

No. of circuits	Model No.	Dimensions (mm)		Q'ty/bag
		A	B	
8	XADRP-08V	7.5	14.7	1,000
10	XADRP-10V	10.0	17.2	1,000
12	XADRP-12V	12.5	19.7	1,000
14	XADRP-14V	15.0	22.2	1,000
16	XADRP-16V	17.5	24.7	1,000
18	XADRP-18V	20.0	27.2	1,000
20	XADRP-20V	22.5	29.7	500
22	XADRP-22V	25.0	32.2	500
24	XADRP-24V	27.5	34.7	500
26	XADRP-26V	30.0	37.2	500
28	XADRP-28V	32.5	39.7	500
30	XADRP-30V	35.0	42.2	500
32	XADRP-32V	37.5	44.7	500
34	XADRP-34V	40.0	47.2	500
36	XADRP-36V	42.5	49.7	250
40	XADRP-40V	47.5	54.7	250

Material and Finish

PA 66, UL94V-0, natural (white)

RoHS2 compliance

XAD CONNECTOR

Retainer

• For receptacle housing

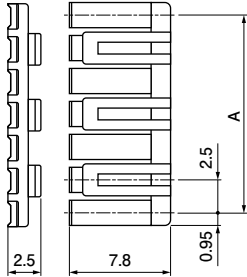

No. of circuits	Model No.	A (mm)	Q'ty/bag	Ref.: Applicable housing model No.
4	XMS-04V	7.5	1,000	XADRR-08V
5	XMS-05V	10.0	1,000	XADRR-10V
6	XMS-06V	12.5	1,000	XADRR-12V
8	XMS-08V	17.5	1,000	XADRR-16V
9	XMS-09V	20.0	1,000	XADRR-18V
10	XMS-10V	22.5	1,000	XADRR-20V
11	XMS-11V	25.0	1,000	XADRR-22V
12	XMS-12V	27.5	1,000	XADRR-24V

Material and Finish

Glass-filled PA 66, UL94V-0, natural (ivory)

RoHS2 compliance

Note: Retainers cannot be used when wires of the insulation outer diameter with 1.7 mm or more are applied. Contact JST for details.

• For plug housing

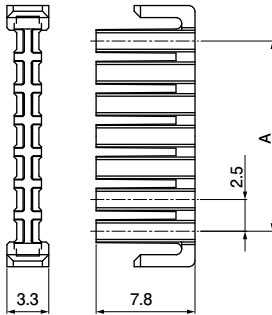

No. of circuits	Model No.	A (mm)	Q'ty/bag	Ref.: Applicable housing model No.
8	XADS-08V-K	7.5	1,000	XADRP-08V
10	XADS-10V-K	10.0	1,000	XADRP-10V
12	XADS-12V-K	12.5	1,000	XADRP-12V
14	XADS-14V-K	15.0	1,000	XADRP-14V
16	XADS-16V-K	17.5	1,000	XADRP-16V
18	XADS-18V-K	20.0	1,000	XADRP-18V
20	XADS-20V-K	22.5	1,000	XADRP-20V
22	XADS-22V-K	25.0	1,000	XADRP-22V
24	XADS-24V-K	27.5	1,000	XADRP-24V
26	XADS-26V-K	30.0	1,000	XADRP-26V
28	XADS-28V-K	32.5	1,000	XADRP-28V
30	XADS-30V-K	35.0	1,000	XADRP-30V
32	XADS-32V-K	37.5	1,000	XADRP-32V
34	XADS-34V-K	40.0	1,000	XADRP-34V
36	XADS-36V-K	42.5	1,000	XADRP-36V
40	XADS-40V-K	47.5	1,000	XADRP-40V

Material and Finish

Glass-filled PA 66, UL94V-0, black

RoHS2 compliance

X-ON Electronics

Largest Supplier of Electrical and Electronic Components

Click to view similar products for [jst manufacturer](#):

Other Similar products are found below :

[GS3-0.5](#) [GS8-6](#) [B08B-JWPF-SK-R](#) [B3PS-VH](#) [B5B-XH-A](#) [B5P-VH](#) [B7B-XH-A](#) [B8B-PH-SM4-TB](#) [FVGS5-6](#) [GS6-16](#) [B34B-PHDSS-B\(LF\)\(SN\)](#) [B3B-ZR-SM4-TF](#) [B4B-PH-SM4-TB](#) [B4PS-VH](#) [B5B-PH-SM4-TB](#) [B6B-PH-SM4-TB](#) [B6B-XH-A](#) [B8B-PH-K-S](#) [IDH-KR-12](#) [10HR-4K](#) [WC-ZE2426](#) [WC-691](#) [WC-122](#) [FVDDF5.5-375A \(LF\)](#) [FVGS12-6 \(LF\)](#) [FVWS2-S3.3 \(LF\)](#) [FVWS5.5-5 \(LF\)](#) [B6PS-VH\(LF\)\(SN\)](#) [FNGS12-6](#) [TWE0.5-8](#) [FVGS4-1 \(LF\)](#) [HILR-06VF-1-S](#) [YRS-1090](#) [WC-GVH2630](#) [WC-PUD2](#) [S10B-PH-SM4-TB\(LF\)\(SN\)](#) [B4B-EH-A-TW \(LF\)\(SN\)](#) [B4B-XH-TW \(LF\)\(SN\)](#) [B5B-PH-TW-S \(LF\)\(SN\)](#) [B8B-PH-TW-S \(LF\)\(SN\)](#) [B9B-XH-A](#) [BM03B-GHS-TBT](#) [BM04B-GHS-TBT](#) [BM06B-GHS-TBT](#) [BM10B-GHS-TBT](#) [10FPZ-SM-TF\(LF\)\(SN\)](#) [YRS-852](#) [B04B-VYHSK-M-1](#) [WC-530](#) [B4B-PH-SM4-GW-TB](#)