

XL CONNECTOR

5.0mm pitch/Disconnectable Crimp style Wire-to-wire connectors

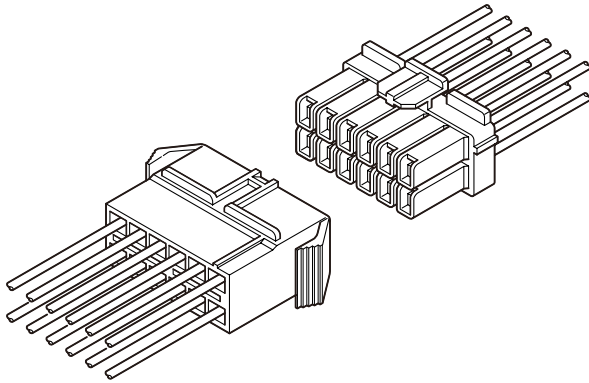

XL connectors are reliable wire-to-wire connectors, used for such electrical and electronic equipment as home appliances, vending machines, and office machines.

- **Reliable housing construction**
- **Easy contact insertion**
- **Box-shaped contact**
- **Two kinds of connections**

Specifications

- Current rating: 10A AC, DC max.
- Voltage rating: 300V AC, DC max.
- Temperature range: -25°C to +90°C
(including temperature rise in applying electrical current)
- Contact resistance: Initial value/7m Ω max.
After environmental testing/10m Ω max.
- Insulation resistance: 1,000M Ω min.
- Withstanding voltage: 1,500V AC/minute
- Applicable wire: AWG #26 to #16
0.13 to 1.25mm²
- Applicable panel thickness: 0.7 to 2.4mm
- * Compliant with RoHS.
- * Refer to "General Instruction and Notice when using Terminals and Connectors" at the end of this catalog.
- * Contact JST for details.

Note: The current rating varies depending on the number of circuits and the wire size used in each connector.
The table below lists the current rating as a function of the number of circuits and wire size.

Current unit: A

Circuits	Wire size (AWG)					
	#16	#18	#20	#22	#24	#26
2	10	6	5	4	3	3
4	9	5	4	3	3	2
8	6	4	3	3	2	2
12	6	4	3	3	2	2
16	5	3	2	2	1	1

Standards

Recognized E60389

Certified LR20812

R75052

Panel layout and Assembly layout

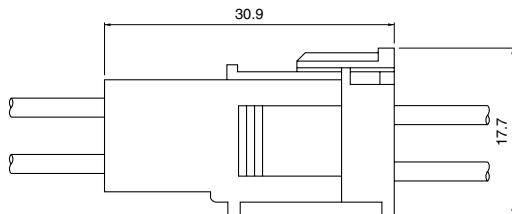

Shape I

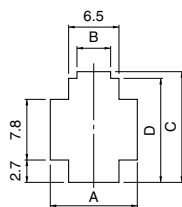

Shape II

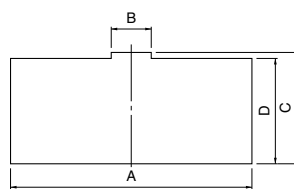

Circuits	Receptacle housing	Panel hole shape	Panel hole dimensions (mm)				General tolerance ±0.13	Applicable panel thickness (mm)
			A	B	C	D		
2	XLR-02V	I	11.5	4.4	13.95	13.2	0.7~2.4	
4	XLR-04V	II	16.5	5.2	13.95	13.2		
8	XLR-08V	II	26.5	5.2	13.95	13.2		
12	XLR-12V	II	36.5	5.2	13.95	13.2		
16	XLR-16V	II	46.5	5.2	13.95	13.2		

- Note: 1. Punch holes in the panel according to the figures and table shown above. Burrs must be removed.
2. The strength of the panel must be considered when punching two or more holes.
3. The connector must be inserted from the same side as the hole is punched.

XL CONNECTOR

Contact

Pin contact

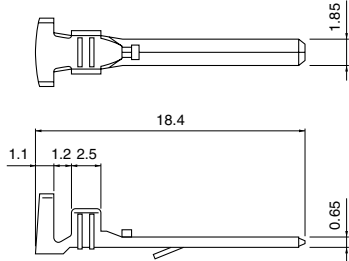

Socket contact

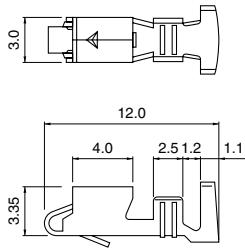

Model No.		Applicable wire		Insulation O.D. (mm)	Q'ty / reel
Pin contact	Socket contact	mm ²	AWG #		
SYM-01T-P0.7	SXF-01T-P0.7	0.13~0.5	26~20	1.3~2.7	Pin contact SYM-01T-P0.7 : 6,000 SYM-41T-P0.7 : 4,000
SYM-41T-P0.7	SXF-41T-P0.7	0.5 ~1.25 0.3+0.3~ 0.5+0.5	20~16 22+22~ 20+20	1.9~3.1 1.7+1.7~ 2.0+2.0	

Material and Finish

Phosphor bronze, tin-plated (reflow treatment)

RoHS compliance

Note: 1. Contact JST for special products.
2. Contact JST for brass products.

Contact	Crimping machine	Applicator		
		Crimp applicator	Dies	Crimp applicator with dies
SYM-01T-P0.7	AP-K2N	MKS-L	MK/SYM-01-07	APLMK SYM01-07
		—	—	—
SXF-01T-P0.7		MKS-L	MK/SXF-01-07	APLMK SXF01-07
		—	—	—
SYM-41T-P0.7		MKS-L	MK/SYM-41-07	APLMK SYM41-07
		—	—	—
SXF-41T-P0.7	MKS-L	MK/SXF-41-07	APLMK SXF41-07	
	—	—	—	

Contact position location numbers

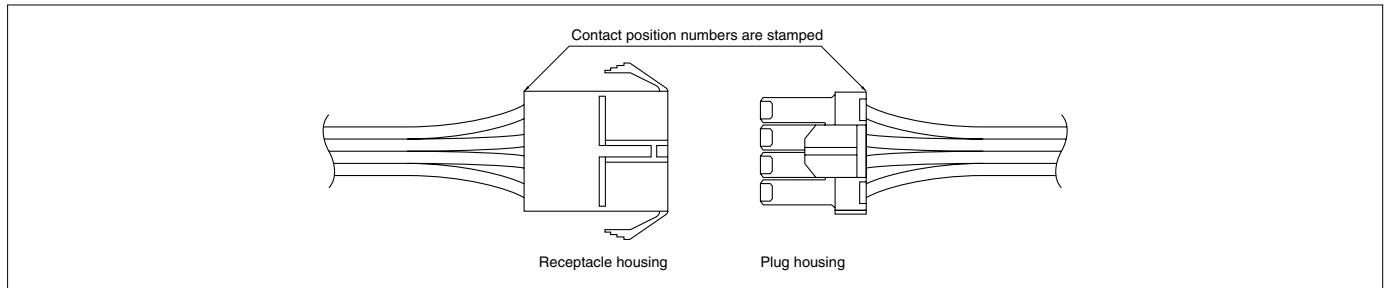

Receptacle housing

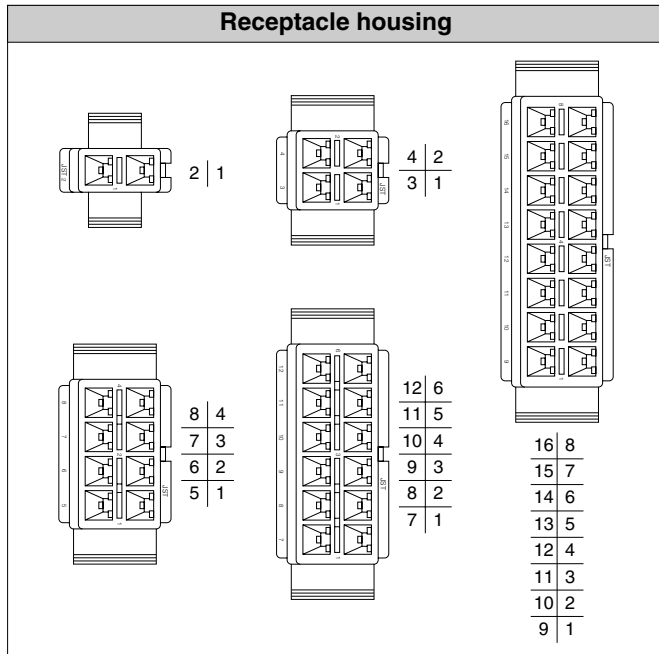

Plug housing

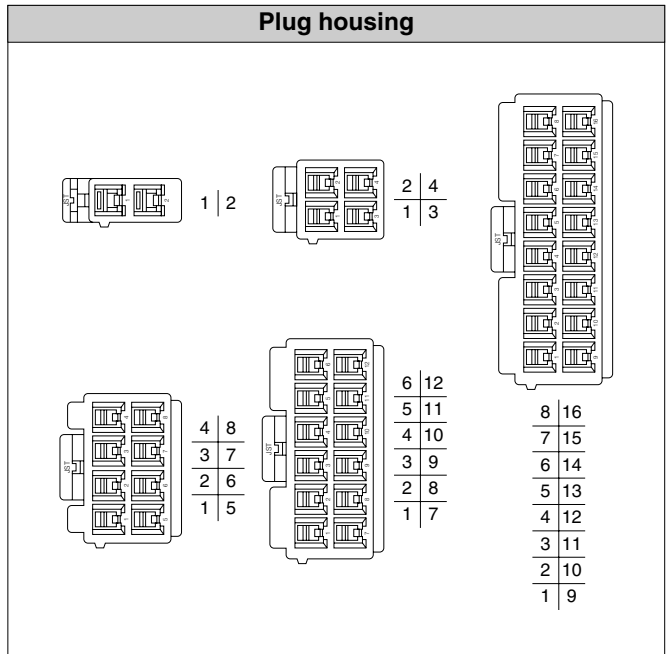

XL CONNECTOR

Housing

Material: PA 66, UL94V-0, white

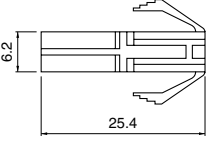
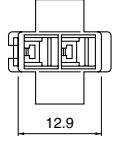
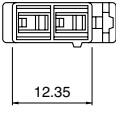
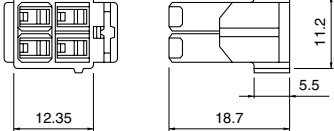
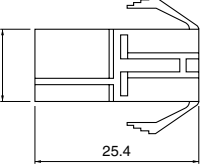
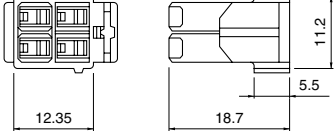
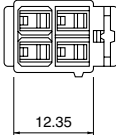
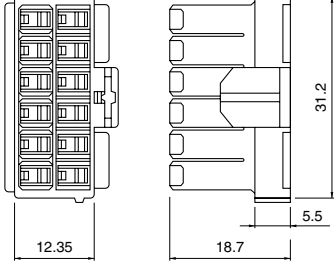
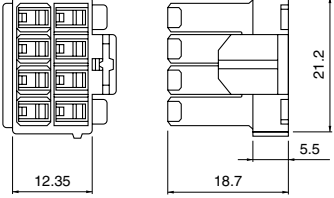
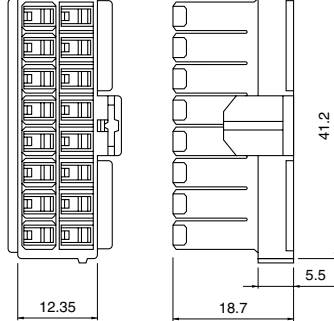
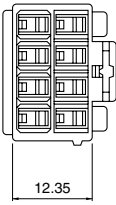
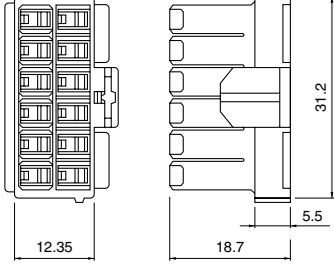
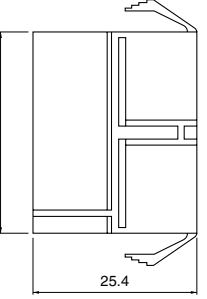
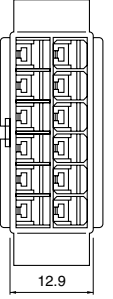
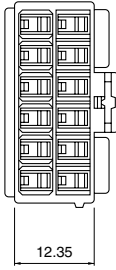
Circuits	Voltage rating	Current rating	Receptacle housing(for pin contact)		Q'ty / bag	Plug housing(for socket contact)		Q'ty / bag
			XLR-02V	XLR-04V		XLP-02V	XLP-04V	
2	300V	10A			500		500	
4	300V	9A			500		500	
8	300V	6A			500		500	
12	300V	6A			200		200	
16	300V	5A			100		200	

RoHS compliance

Note: 1. XL connectors with any number of circuits can be used either panel mounted or free hanging. See "Panel layout" for the hole dimensions.
2. Contact JST for special products.

X-ON Electronics

Largest Supplier of Electrical and Electronic Components

Click to view similar products for [Headers & Wire Housings](#) category:

Click to view products by [JST](#) manufacturer:

Other Similar products are found below :

[0015917161](#) [0022155065](#) [57102-F02-18ULF](#) [58102-G61-06LF](#) [582553-1](#) [01.001.5753.1](#) [0050291907](#) [02.125.8002.8](#) [609-3404](#) [61062-3](#)
[CSU011177004](#) [622-0430](#) [622-3653LF](#) [63453-116](#) [636-1030](#) [636-1427](#) [636-3427](#) [636-4007](#) [641938-9](#) [65495-038](#) [65692-001LF](#) [65781-018](#)
[65781-047](#) [65817-010LF](#) [65817-015LF](#) [67095-007LF](#) [67601157](#) [68631-112](#) [68645-018](#) [699319-000](#) [70.362.1628.0](#) [70-4210](#) [70-4226B](#) [70-](#)
[4853B](#) [71.350.2428.0](#) [733-134](#) [733-162](#) [MHR-64-VUAL](#) [80.063.4001.1](#) [800-90-001-10-001000](#) [801-43-002-10-013000](#) [801-43-006-10-](#)
[002000](#) [803-43-024-10-001000](#) [803-93-012-10-001000](#) [8-1437020-4](#) [819-22-004-30-001101](#) [820-22-006-30-001101](#) [820-22-008-30-001101](#)
[821-22-002-10-001101](#) [821-22-003-10-002101](#)