

# XMA CONNECTOR

2.5 mm pitch/Disconnectable Crimp style Wire-to-wire connectors

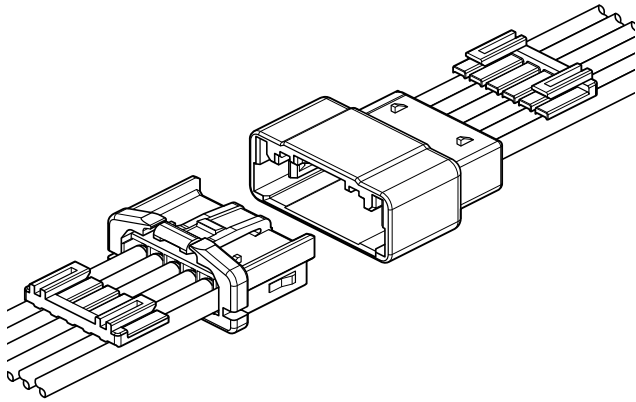

This connector is a 2.5 mm pitch wire-to-wire connector, having incomplete mating prevention mechanism. 2-circuit and 3-circuit connectors have control key to prevent connector from mating with incorrect circuits, thus, several same circuit connectors can be used.

- Inertial lock structure with side lock mechanism
- 5 type combination of control key with one kind of circuit
- Secure locking structure
- Finger-friendly design

## Specifications

- Current rating: 3 A AC/DC (AWG#22)
  - Voltage rating: 250 V AC/DC
  - Temperature range: -25°C to +85°C  
(including temperature rise in applying electrical current)
  - Contact resistance: Initial value/ 10 mΩ max.  
After environmental tests/ 20 mΩ max.
  - Insulation resistance: 500 MΩ min.
  - Withstanding voltage: 1,500 VAC/minute
  - Applicable wire: AWG#26 to #22  
0.13 mm<sup>2</sup> to 0.33 mm<sup>2</sup>
- \* In using the products, refer to "Handling Precautions for Terminals and Connectors" described on our website (Technical documents of Product information page).
- \* RoHS2 compliance
- \* Dimensional unit: mm
- \* Contact JST for details.

## Standards

- Ⓜ Recognized E 60389
- Ⓢ Certified LR20812

## Assembly layout

(2, 3 circuits)

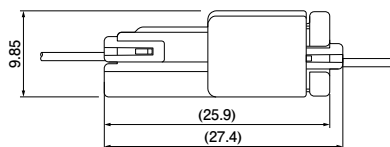

(4, 5 circuits)

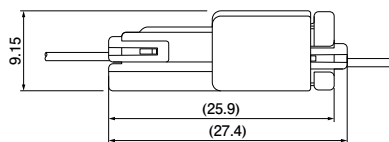

(6 circuits)

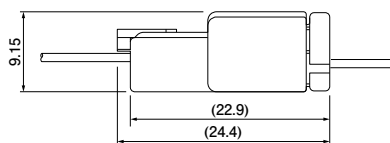

Note: The dimensions above should serve as a guideline. Contact JST for details.

# XMA CONNECTOR

## Contact

### ● Pin contact

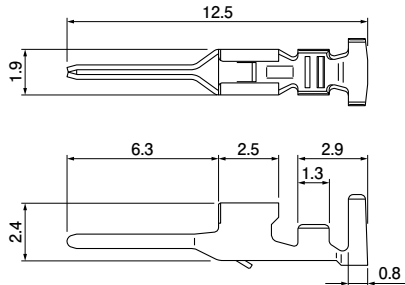

### ● Socket contact

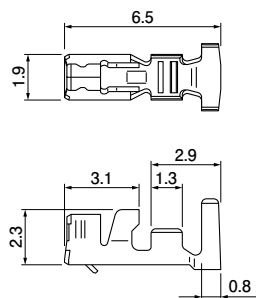

Model No.		Applicable wire		Insulation O.D. (mm)	Q'ty/reel	
Pin contact	Socket contact	mm <sup>2</sup>	AWG #		Pin contact	Socket contact
SXM-001T-P0.6	SXA-001T-P0.6L	0.13~0.33	26~22	1.3~1.9	7,000	8,000

### Material and Finish

Copper alloy, tin-plated (reflow treatment)

### RoHS2 compliance

Contact	Crimping machine	Applicator		
		Crimp applicator	Dies	Crimp applicator with dies
SXM-001T-P0.6	AP-K2N	MKS-L	MK/SXA/M-001-06	APLMK SXA/M001-06
SXA-001T-P0.6L			MK/SXA-001-06L	APLMK SXA001-06L

Note: Contact JST for fully automatic crimping applicator.

## Receptacle housing (for pin contact)

### (2, 3 circuits)

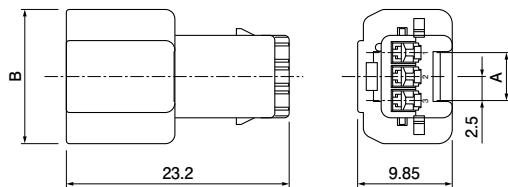

### (4, 5 circuits)

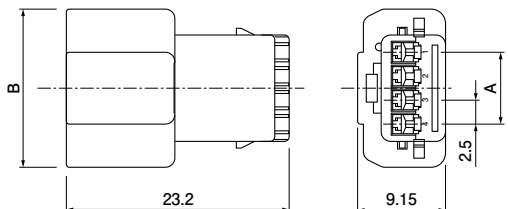

### (6 circuits)

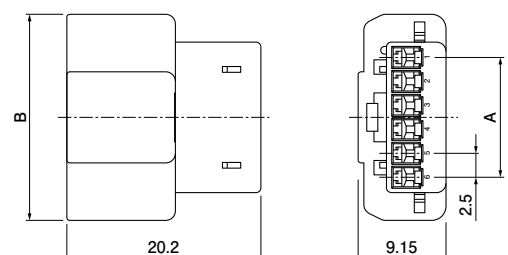

No. of circuits	Model No.	Color	Dimensions (mm)		Q'ty/bag
			A	B	
2	XMAR-02VF-1-S	Natural (white)	2.5	12.5	1,000
	XMAR-02VF-2-R	Red			
	XMAR-02VF-3-E	Blue			
	XMAR-02VF-4-Y	Yellow			
	XMAR-02VF-5-PK	Pink			
3	XMAR-03VF-1-S	Natural (white)	5.0	14.0	1,000
	XMAR-03VF-2-R	Red			
	XMAR-03VF-3-E	Blue			
	XMAR-03VF-4-Y	Yellow			
4	XMAR-04VF-S	Natural (white)	7.5	16.5	500
5	XMAR-05VF-S	Natural (white)	10.0	19.0	500
6	XMAR-06VF-S	Natural (white)	12.5	21.5	500

### Material and Finish

Glass-filled PBT, UL94V-0

### RoHS2 compliance

# XMA CONNECTOR

## Plug housing (for socket contact)

(2, 3 circuits)

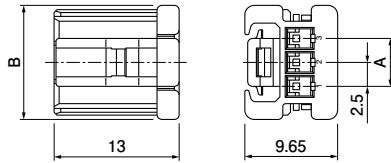

(4, 5 circuits)

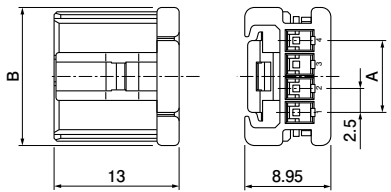

(6 circuits)

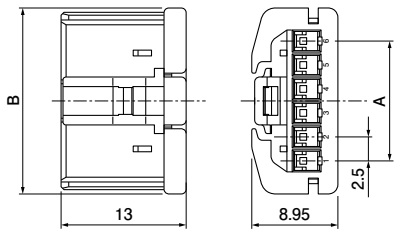

No. of circuits	Model No.	Color	Dimensions (mm)		Q'ty/bag
			A	B	
2	XMAP-02V-1-S	Natural (white)	2.5	9.4	1,000
	XMAP-02V-2-R	Red			
	XMAP-02V-3-E	Blue			
	XMAP-02V-4-Y	Yellow			
	XMAP-02V-5-PK	Pink			
3	XMAP-03V-1-S	Natural (white)	5.0	11.9	1,000
	XMAP-03V-2-R	Red			
	XMAP-03V-3-E	Blue			
	XMAP-03V-4-Y	Yellow			
4	XMAP-04V-S	Natural (white)	7.5	14.4	1,000
5	XMAP-05V-S	Natural (white)	10.0	16.9	500
6	XMAP-06V-S	Natural (white)	12.5	19.4	500

### Material and Finish

Glass-filled PBT, UL94V-0

RoHS2 compliance

## Retainer

(2 to 5 circuits)

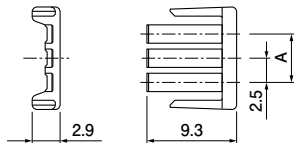

(6 circuits)

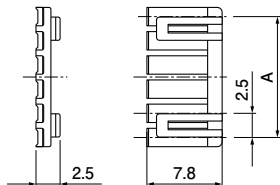

No. of circuits	Model No.	Color	Dimensions (mm)	Q'ty/bag
			A	
2	XMAS-02V-S	Natural (ivory)	2.5	1,000
3	XMAS-03V-S	Natural (ivory)	5.0	1,000
4	XMAS-04V-S	Natural (ivory)	7.5	1,000
5	XMAS-05V-S	Natural (ivory)	10.0	1,000
6	XMS-06V	Natural (ivory)	12.5	1,000

### Material and Finish

Glass-filled PA 66, UL94V-0

RoHS2 compliance

Note: 6 circuits of retainer is interchangeable with those of the XM and XA connectors.

## X-ON Electronics

Largest Supplier of Electrical and Electronic Components

*Click to view similar products for [Headers & Wire Housings](#) category:*

*Click to view products by [JST](#) manufacturer:*

Other Similar products are found below :

[0015917161](#) [0022155065](#) [57102-F02-18ULF](#) [58102-G61-06LF](#) [582553-1](#) [01.001.5753.1](#) [0050291907](#) [02.125.8002.8](#) [609-3404](#) [61062-3](#)  
[CSU011177004](#) [622-0430](#) [622-3653LF](#) [63453-116](#) [636-1030](#) [636-1427](#) [636-3427](#) [636-4007](#) [641938-9](#) [65495-038](#) [65692-001LF](#) [65781-018](#)  
[65781-047](#) [65817-010LF](#) [65817-015LF](#) [67095-007LF](#) [67601157](#) [68631-112](#) [68645-018](#) [699319-000](#) [70.362.1628.0](#) [70-4210](#) [70-4226B](#) [70-](#)  
[4853B](#) [71.350.2428.0](#) [733-134](#) [733-162](#) [MHR-64-VUAL](#) [80.063.4001.1](#) [800-90-001-10-001000](#) [801-43-002-10-013000](#) [801-43-006-10-](#)  
[002000](#) [803-43-024-10-001000](#) [803-93-012-10-001000](#) [8-1437020-4](#) [819-22-004-30-001101](#) [820-22-006-30-001101](#) [820-22-008-30-001101](#)  
[821-22-002-10-001101](#) [821-22-003-10-002101](#)