

XMA CONNECTOR

2.5 mm pitch/Disconnectable Crimp style Wire-to-wire connectors

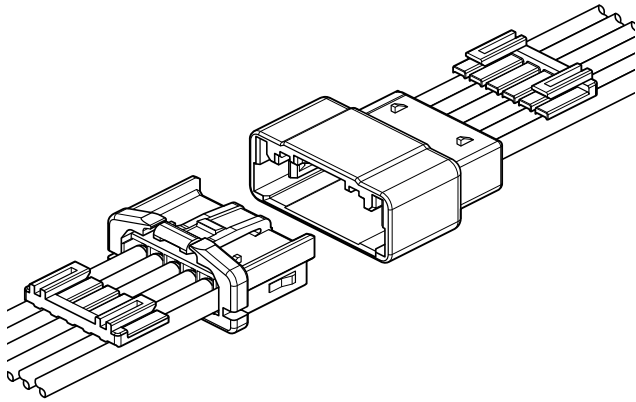

This connector is a 2.5 mm pitch wire-to-wire connector, having incomplete mating prevention mechanism. 2-circuit and 3-circuit connectors have control key to prevent connector from mating with incorrect circuits, thus, several same circuit connectors can be used.

- Inertial lock structure with side lock mechanism
- 5 type combination of control key with one kind of circuit
- Secure locking structure
- Finger-friendly design

Specifications

- Current rating: 3 A AC/DC (AWG#22)
 - Voltage rating: 250 V AC/DC
 - Temperature range: -25°C to +85°C
(including temperature rise in applying electrical current)
 - Contact resistance: Initial value/ 10 mΩ max.
After environmental tests/ 20 mΩ max.
 - Insulation resistance: 500 MΩ min.
 - Withstanding voltage: 1,500 VAC/minute
 - Applicable wire: AWG#26 to #22
0.13 mm² to 0.33 mm²
- * In using the products, refer to "Handling Precautions for Terminals and Connectors" described on our website (Technical documents of Product information page).
- * RoHS2 compliance
- * Dimensional unit: mm
- * Contact JST for details.

Standards

- ⚡ Recognized E 60389
- Ⓢ Certified LR20812

Assembly layout

(2, 3 circuits)

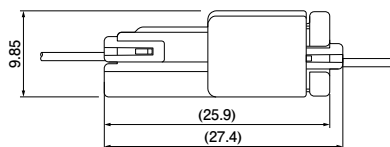

(4, 5 circuits)

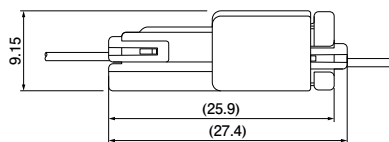

(6 circuits)

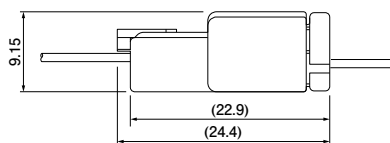

Note: The dimensions above should serve as a guideline. Contact JST for details.

XMA CONNECTOR

Contact

● Pin contact

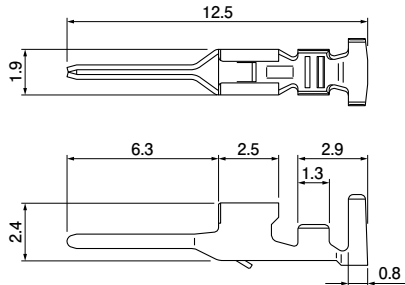

● Socket contact

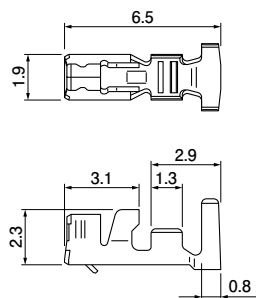

Model No.		Applicable wire		Insulation O.D. (mm)	Q'ty/reel	
Pin contact	Socket contact	mm ²	AWG #		Pin contact	Socket contact
SXM-001T-P0.6	SXA-001T-P0.6L	0.13~0.33	26~22	1.3~1.9	7,000	8,000

Material and Finish

Copper alloy, tin-plated (reflow treatment)

RoHS2 compliance

Contact	Crimping machine	Applicator		
		Crimp applicator	Dies	Crimp applicator with dies
SXM-001T-P0.6	AP-K2N	MKS-L	MK/SXA/M-001-06	APLMK SXA/M001-06
SXA-001T-P0.6L			MK/SXA-001-06L	APLMK SXA001-06L

Note: Contact JST for fully automatic crimping applicator.

Receptacle housing (for pin contact)

(2, 3 circuits)

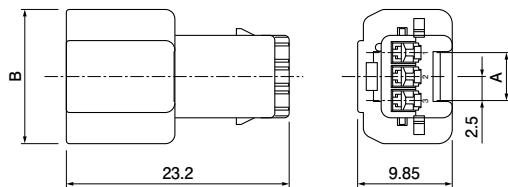

(4, 5 circuits)

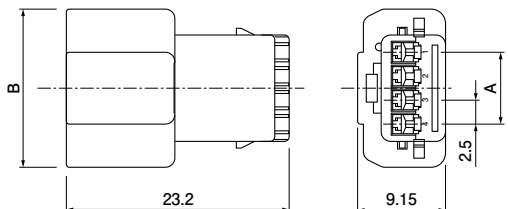

(6 circuits)

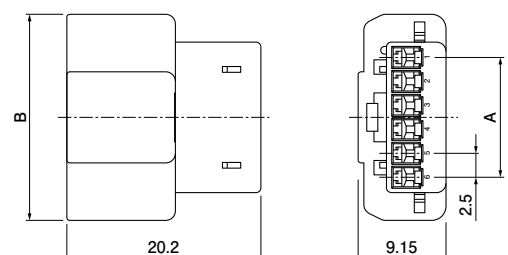

No. of circuits	Model No.	Color	Dimensions (mm)		Q'ty/bag
			A	B	
2	XMAR-02VF-1-S	Natural (white)	2.5	12.5	1,000
	XMAR-02VF-2-R	Red			
	XMAR-02VF-3-E	Blue			
	XMAR-02VF-4-Y	Yellow			
	XMAR-02VF-5-PK	Pink			
3	XMAR-03VF-1-S	Natural (white)	5.0	14.0	1,000
	XMAR-03VF-2-R	Red			
	XMAR-03VF-3-E	Blue			
	XMAR-03VF-4-Y	Yellow			
4	XMAR-04VF-S	Natural (white)	7.5	16.5	500
5	XMAR-05VF-S	Natural (white)	10.0	19.0	500
6	XMAR-06VF-S	Natural (white)	12.5	21.5	500

Material and Finish

Glass-filled PBT, UL94V-0

RoHS2 compliance

XMA CONNECTOR

Plug housing (for socket contact)

(2, 3 circuits)

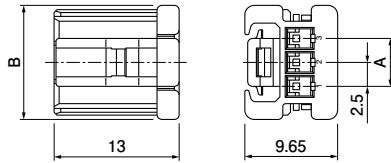

(4, 5 circuits)

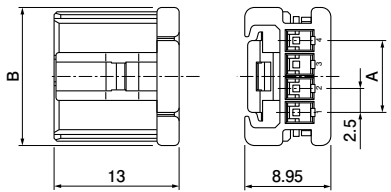

(6 circuits)

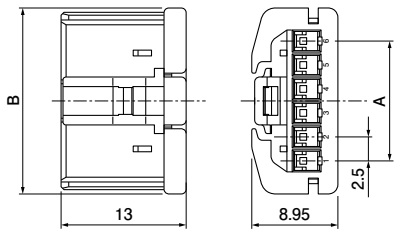

No. of circuits	Model No.	Color	Dimensions (mm)		Q'ty/bag
			A	B	
2	XMAP-02V-1-S	Natural (white)	2.5	9.4	1,000
	XMAP-02V-2-R	Red			
	XMAP-02V-3-E	Blue			
	XMAP-02V-4-Y	Yellow			
	XMAP-02V-5-PK	Pink			
3	XMAP-03V-1-S	Natural (white)	5.0	11.9	1,000
	XMAP-03V-2-R	Red			
	XMAP-03V-3-E	Blue			
	XMAP-03V-4-Y	Yellow			
4	XMAP-04V-S	Natural (white)	7.5	14.4	1,000
5	XMAP-05V-S	Natural (white)	10.0	16.9	500
6	XMAP-06V-S	Natural (white)	12.5	19.4	500

Material and Finish

Glass-filled PBT, UL94V-0

RoHS2 compliance

Retainer

(2 to 5 circuits)

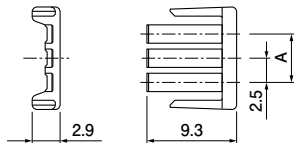

(6 circuits)

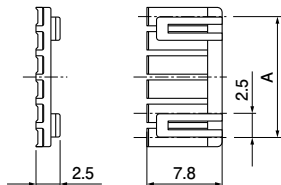

No. of circuits	Model No.	Color	Dimensions (mm)	Q'ty/bag
			A	
2	XMAS-02V-S	Natural (ivory)	2.5	1,000
3	XMAS-03V-S	Natural (ivory)	5.0	1,000
4	XMAS-04V-S	Natural (ivory)	7.5	1,000
5	XMAS-05V-S	Natural (ivory)	10.0	1,000
6	XMS-06V	Natural (ivory)	12.5	1,000

Material and Finish

Glass-filled PA 66, UL94V-0

RoHS2 compliance

Note: 6 circuits of retainer is interchangeable with those of the XM and XA connectors.

X-ON Electronics

Largest Supplier of Electrical and Electronic Components

Click to view similar products for [Headers & Wire Housings](#) category:

Click to view products by [JST](#) manufacturer:

Other Similar products are found below :

[95000-104TRLF](#) [10135584-644402LF](#) [DF62W-EP2022PCA](#) [95000-106TRLF](#) [DF62W-2022SCA](#) [DF62W-EP2022PC](#) [2203348](#) [DF62W-2022SC](#) [1084018](#) [1029039](#) [1084017](#) [802-10-012-10-002000](#) [1112640](#) [1112639](#) [891-007-9SS-BST1T](#) [000-34000](#) [0008550134](#) [0009482033](#) [0009507031](#) [57102-F02-18ULF](#) [57102-S06-03LF](#) [57202-S52-04LF](#) [PCN6-15S-2.5E](#) [0039019024](#) [58102-G61-06LF](#) [582553-1](#) [0009485154](#) [0009508121](#) [0022285053](#) [0050291907](#) [018731A](#) [LY20-4P-DT1-P1E-BR](#) [02.125.8002.8](#) [60101931](#) [60598-1 \(Cut Strip\)](#) [M1625-3R/100](#) [61062-3](#) [61082-181009](#) [CSU011177004](#) [636-1427](#) [638009-1](#) [641938-9](#) [641991-4](#) [644168-1](#) [644827-2](#) [647662-1](#) [65039-019ELF](#) [65692-001LF](#) [65781-018](#) [65781-047](#)