

# APPLICATION TOOLING

Crimping tools and machines

**Crimping tools and machines**

The arrow mark indicates the press that is applicable to the applicator.

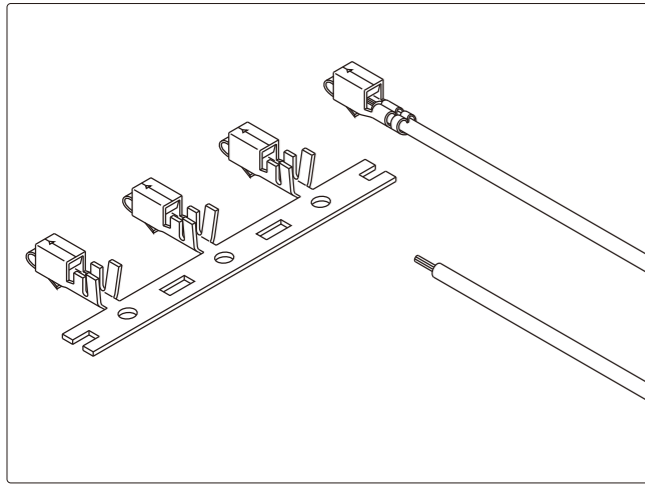

**Strip-crimp applicator  
for side feeding terminals**

MKS-L

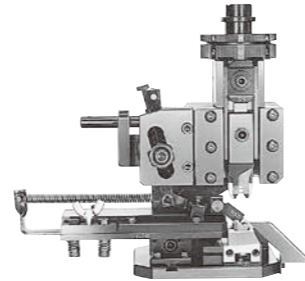

**Crimping applicator  
for end-feeding terminals**

MK-L

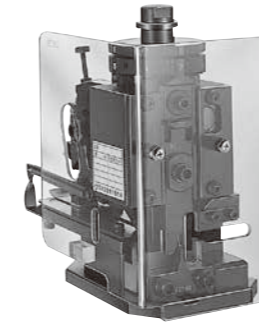

## Semi-automatic press

Semi-automatic crimping machines (presses) contact a wire to a chain terminal each time a footswitch is pressed.

AP-K2N

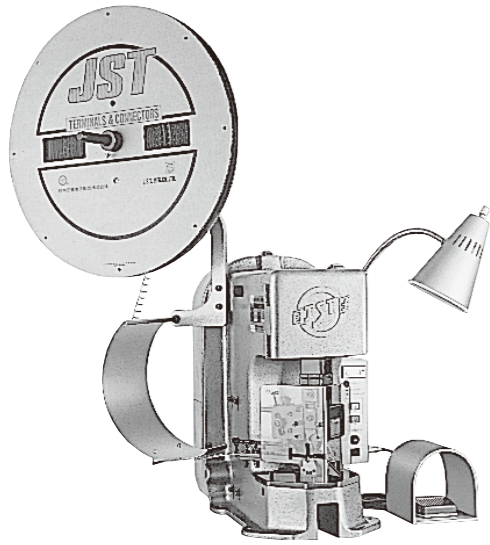







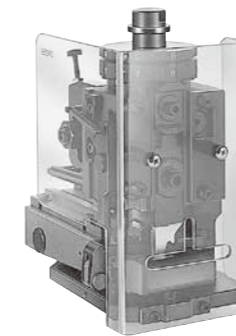

- Dimensions:  
(W×L×H)280×480×505 mm
- Weight:  
Approx. 90 kg(198 lb)
- Power source:  
100 VAC, Single-phase 50/60 Hz
- Pressure output:  
14.7 kN[1,500 kg(3307 lb)]
- Dies:  
Applicator replacement

**Crimping applicator  
for end-feeding flag terminals**

MKF-L



### Crimping tools

Terminals and parts model number in alphabetical order	Hand tools					Hand tools			Extraction and Insertion tools	
	for chain terminals	for loose piece terminals				for loose piece terminals			Extraction tool	Insertion tool
	YRS series	YC series	YRM series	YRF series	YRK series	YRK-EX series				
										
	Dimensions: (W×L) 59×224 mm	Dimensions: (W×L) 70×296 mm	Dimensions: (W×L) 59×224 mm	Dimensions: (W×L) 70×295 mm 80×305 mm	Dimensions: (W×L×D) 75×314×25 mm	Dimensions: (W×L×D) 75×314×25 mm				
	<p><b>Crimping tools</b> It is the manual tool that is convenient to terminate very small quantity of contacts for prototype or maintenance. It is composed of two crimping dies for the conductor and insulation, and can be crimp easily. YRK and YRK-EX can be used for mass-production.</p> <p>Note: (1) These tools are for prototype tooling or repair. (2) YC tool has two crimping sections (A and B). YRS tool has also two crimping sections by inverting upper dies. Be sure to check applicable wires before use. Since the dies are fixed, the crimping height cannot be adjusted. Therefore, some of the applicable wires described in this catalog may not be crimped properly. Before use, check for proper crimping (such as tensile strength, terminal/contact deformation). (3) These tools are not applicable to 2-wire crimping. (4) When hand crimping board-in terminals (SAN, SCN, SDN, SGN, SIN, SJN, SZN), care should be taken not to contaminate the solder tails of the terminals, as with greasy or oily fingers. If a solder problem arises, some cleaning of the tips of the terminal is advisable. (5) WC and JUC hand tools are provided by J.S.T.(U.K.) LTD. and contact them about the details of these hand tools.</p>									
	YRS series	YC series	YRM series	YRF series	YRK · YRK-EX series	WC & JUC series JUK's Hand Tools	Terminal in loose form model No.			
JK-SP2*** / JK-SS2***	YRS-370	—	—	—	—	—	—	KEJ-0.7 for plug, KEJ-0.4 for socket	—	
J-SP1*** / J-SS1***	YRS-440	YC-440	—	—	—	—	J-BP/BS1***	DEJ-0.3	—	
J-SP2*** / J-SS2***	YRS-330	—	—	—	—	—	—	DEJ-0.3	—	
LFO-1.0-250N	—	—	—	—	—	JUCS-FO	—	—	—	
LFO-2.5-250N	—	—	—	—	—	JUCS-FO	—	—	—	
MD-SP12**	YRS-470	—	—	—	—	—	—	MEJ-06	—	
MD-SP22**	YRS-460	—	—	—	—	—	—	MEJ-06	—	
RA-SC1290	YRS-231	—	YRM-232 YRM-233	—	—	—	RA-BC12**	EJ-RA	—	
RF-SC22**	—	—	YRM-230	—	—	—	RF-BC22**	—	—	
RPJ-SP2331 RPJ-SS2331	YRS-331	—	—	—	—	—	—	EJ-RPJ	—	
SAA-21(T)**	—	YC-141	—	—	—	—	LAA-21(T)**	—	—	
SAA-50(T)**	—	YC-182	—	—	—	—	LAA-50(T)**	—	—	
SAA-51(T)**	—	YC-142	—	—	—	—	LAA-51(T)**	—	—	
SAB-51(T)**	—	YC-142	—	—	—	—	LAB-51(T)**	—	—	
SACH-003G-P0.2	YRS-1190	—	—	—	—	—	—	—	—	
SAGH-002GU-P0.3	YRS-858	—	—	—	—	—	—	—	—	
SAN-002T-0.8A SAN-002T-0.8K	YRS-220	—	—	—	—	—	—	EJ-PH	—	
SBH-001T-P0.5	—	YC-670R	—	—	—	WC-670	BBH-001T-P0.5	—	—	
SBHL-002T-P0.5	YRS-857	—	—	—	—	—	—	—	—	
SBHM-001T-P0.5	—	YC-670R	—	—	—	—	BBHM-001T-P0.5	EJ-BHMR	—	
SBHS-002T-P0.5A	YRS-852	—	—	—	—	—	—	EJ-BHS2	—	
SBHS-002T-P0.5A	—	—	—	—	—	—	—	EJ-BHS2	—	
SBHSM-002T-P0.5	YRS-854	—	—	—	—	—	—	EJ-BHSW	—	
SBHT-002T-P0.5	YRS-856 YRS-857	—	—	—	—	—	—	EJ-BHT	—	
SBN-001T-1.0	YRS-170	YC-170R	—	—	—	—	BBN-001T-1.0	—	—	
SCN-001T-1.0K SCN-001T-P1.0	YRS-191	YC-191R	—	—	—	WC-191	BCN-001T-1.0K BCN-001T-P1.0	—	—	
SCS-41T-2.3	—	—	—	—	—	—	—	CSJ-23	—	
SCSH-002T-P0.2N	YRS-1350	—	—	—	—	—	—	—	—	

Note: Contact JST for wire range.

Crimping tools

Terminals and parts model number in alphabetical order	Hand tools					Hand tools			Extraction and Insertion tools	
	for chain terminals	for loose piece terminals				for loose piece terminals			Extraction tool	Insertion tool
	YRS series	YC series	YRM series	YRF series	YRK · YRK-EX series	WC & JUC series JUK's Hand Tools	Terminal in loose form model No.			
SCSN-41T-P2.3	—	—	—	—	—	—	—	—	EJ-CSN	—
SCZH-002T-P0.5	YRS-492	—	—	—	—	—	—	—	—	—
SDACP-002T-M0.9	YRS-1530 YRS-1531	—	—	—	—	—	—	—	—	—
SDF-01T-1.0A SDF-01T-1.3AS	—	YC-045	—	—	—	—	—	LDF-01T-1.0A LDF-01T-1.3AS	—	—
SDN-21T-P1.5	—	YC-600R	—	—	—	—	—	BDN-21T-P1.5	—	—
SDY-01T-P1.6ASV	—	YC-525R	—	—	—	—	—	BDY-01T-P1.6ASV	SLJ-1.4	—
SEH-001T-P0.6	YRS-260	YC-260R	—	—	—	—	WC-260	BEH-001T-P0.6	EJ-PH	—
SEH-001T-P0.6L	—	—	—	—	—	—	—	—	EJ-PH	—
SEH-002T-P0.6L	—	—	—	—	—	—	—	—	EJ-PH	—
SEH-003T-P0.6L	—	—	—	—	—	—	—	—	EJ-PH	—
SF1F-01GC-P0.6 SF1M-01GC-M0.6A	—	—	—	—	YRK-1230	—	—	—	—	—
SF1F-002T(GC)-P0.6 SF1M-002T(GC)-M0.6A	—	—	—	—	YRK-1220	—	—	—	EJ-JFAJ1100	—
SF1F-21T(GC)-P0.6 SF1M-21T(GC)-M0.6A	—	—	—	—	YRK-1210	—	—	—	EJ-JFAJ1100	—
SF3F-002(*)-P2.0 SF3M-002(*)-M2.0N	—	—	—	YRF-882	YRK-8821	—	—	BF3F-002(*)-P2.0 BF3M-002(*)-M2.0N	EJ-JFAJ3	—
SF3F-01(*)-P2.0 BF3M-002(*)-M2.0N	—	—	—	YRF-881	YRK-8811	—	—	BF3F-01(*)-P2.0 BF3M-01(*)-M2.0N	EJ-JFAJ3	—
SF3F-41(*)-P2.0 SF3M-41(*)-M2.0N	—	—	—	YRF-880	YRK-8801	—	—	LF3F-41(*)-P2.0 LF3M-41(*)-M2.0N	EJ-JFAJ3	—
SF3F-71(*)-P2.0 SF3M-71(*)-M2.0N	—	—	—	YRF-1070	YRK-1071	—	—	BF3F-71(*)-P2.0 BF3M-71(*)-M2.0N	EJ-JFAJ3	—
SFO-41(T)-187N(-8)	—	YC-271	—	—	—	—	—	LFO-41(T)-187N	—	—
SFO-61(T)-250A	—	YC-270	—	—	—	—	—	LFO-61(T)-250A	—	—
SFPS-61T-250	—	YC-272	—	—	—	—	—	LFPS-61(T)-250	—	—
SFT-61T-250N	—	YC-510	—	—	—	—	—	LFT-61T-250N	—	—
SGF-41(T)-4	—	YC-055	—	—	—	—	—	LGF-41(T)-4	—	—
SGF-51(T)-5	—	YC-065	—	—	—	—	—	LGF-51(T)-5 LGF-51(T)-5A	—	—
SGHD-002GA-P0.2	YRS-1590	—	—	—	—	—	—	—	—	—
SGM-51T-5	—	YC-056	—	—	—	—	—	LGM-51T-5	—	—
SGVH-002T-P0.2	YRS-1590	—	—	—	—	—	—	—	—	—
SHCM-A03T-P025	YRS-960	—	—	—	—	—	WC-SHCM-A03	—	—	—
SHF-001T-0.8BS	YRS-122	YC-122R	—	—	—	—	WC-122	BHF-001T-0.8BS	EJ-SMP (Note1)	—
SHF-002T-0.8BS	YRS-300	—	—	—	—	—	—	—	EJ-SMP (Note1)	—
SHIF-01T-P0.5	—	YC-985R	—	—	—	—	—	—	EJ-HILP	—
SHIF-21T-P0.5	—	YC-995R	—	—	—	—	—	—	EJ-HILP	—
SHIM-01T-P0.5	—	YC-985R	—	—	—	—	—	—	EJ-HILR	—
SHIM-21T-P0.5	—	YC-995R	—	—	—	—	—	—	EJ-HILR	—
SHR-001T-P0.6	YRS-580	YC-580R	—	—	—	—	—	BHR-001T-P0.6	—	—
SHYVF-21T-M0.5	—	—	—	—	—	—	—	—	EJ-BNI	—
SHYVF-41T-M0.5	—	—	—	—	—	—	—	—	EJ-BNI	—
SIM-01(T)-110A	—	YC-054	—	—	—	—	—	LIM-01(T)-110A	—	—
SIM-1.0-250D/N	—	—	—	—	—	—	JUCS-IM	—	—	—
SIM-2.5-250D/N	—	—	—	—	—	—	JUCS-IM	—	—	—
SIM-41(T)-110B	—	YC-067	—	—	—	—	—	LIM-41(T)-110B	—	—
SIM-51(T)-250N	—	YC-321	—	—	—	—	—	LIM-51(T)-250N	—	—

Note 1: Please use EJ-SMP as an extraction tool when using the combination with SM connector 18-circuit housing.  
2: Contact JST for wire range.

Crimping tools

Terminals and parts model number in alphabetical order	Hand tools					Hand tools			Extraction and Insertion tools	
	for chain terminals	for loose piece terminals				for loose piece terminals			Extraction tool	Insertion tool
	YRS series	YC series	YRM series	YRF series	YRK · YRK-EX series	WC & JUC series JUK's Hand Tools	Terminal in loose form model No.			
SIN-001T-1.2	YRS-034	--	--	--	--	--	--	--	--	--
SIN-002T-1.0S	YRS-035	--	--	--	--	--	--	--	--	--
SIN-01T-1.2	--	YC-340R	--	--	--	--	--	LIN-01T-1.2	--	--
SIN-01T-1.8	--	YC-032	--	--	--	--	--	LIN-01T-1.8	--	--
SIN-01T-1.8N	--	YC-032	--	--	--	--	--	LIN-01T-1.8N	--	--
SIN-21T-1.8	--	YC-350	--	--	--	--	--	LIN-21T-1.8	--	--
SIN-21T-1.8S	--	YC-570 YC-571	--	--	--	--	--	LIN-21T-1.8S	--	--
SIN-61T-2.6S	--	YC-560	--	--	--	--	--	LIN-61T-2.6S	--	--
SIN-81T-3.6S	--	YC-940	--	--	--	--	--	LIN-81T-3.6S	--	--
SIN-91T-4.7S	--	--	--	--	YRK-1630	--	--	--	--	--
SJ2F-002GF-P1.0 SJ2M-002GF-M1.0N	YRS-8851	--	--	--	YRK-8851	--	--	--	EJ-JFAJ2N	--
SJ2F-01GF-P1.0 SJ2M-01GF-M1.0N SJ2M-01GF-M1.0S	YRS-8861	--	--	--	YRK-8861	--	--	--	EJ-JFAJ2N	--
SJ2F-21GF-P1.0 SJ2M-21GF-M1.0N	--	--	--	YRF-1120	YRK-1120	--	--	LJ2F-21GF-P1.0 LJ2M-21GF-M1.0N	EJ-JFAJ2N	--
SJ3F-002GF-P1.8	--	--	--	YRF-882	--	--	--	--	--	--
SJ3F-01GF-P1.8	--	--	--	YRF-881	--	--	--	--	--	--
SJ3F-41GF-P1.8	--	--	--	YRF-880	--	--	--	--	--	--
SJ4F-71GF-M3.0	--	--	--	YRF-1130	--	--	--	BJ4F-71GF-M3.0	EJ-JFAJ4	--
SJ4F-81GF-M3.0	--	--	--	YRF-1370	--	--	--	BJ4F-81GF-M3.0	EJ-JFAJ4	--
SJ5F-71GF-M6.5 SJ5M-71GF-M6.5	--	--	--	YRF-888	--	--	--	BJ5F-71GF-M6.5 BJ5M-71GF-M6.5	EJ-JFAJ5	--
SJ5F-81GF-M6.5 SJ5M-81GF-M6.5	--	--	--	YRF-889	--	--	--	LJ5F-81GF-M6.5 LJ5M-81GF-M6.5	EJ-JFAJ5	--
SJ5F-91GF-M6.5 SJ5M-91GF-M6.5	--	--	--	--	--	--	--	LJ5F-91GF-M6.5 LJ5M-91GF-M6.5	EJ-JFAJ5	--
SJFPS-81T-M1.0	--	--	--	YRF-1610	--	--	--	--	--	--
SJN-001PT-0.9	YRS-1181	--	--	--	--	--	--	--	--	--
SJN-002PT-0.9	YRS-036	--	--	--	--	--	--	--	--	--
SJWPSR-21T-P1.0 SJWPST-21T-M1.0N	--	--	--	--	--	--	--	--	EJ-JWPS-RT	--
SLC-21T-2.0	--	YC-310	--	--	--	--	WC-310	LLC-21T-2.0	--	--
SLC-001T-P2.0	--	--	--	--	--	--	--	--	EJ-LCL	--
SLC-02T-P2.0	--	--	--	--	--	--	--	--	EJ-LCL	--
SLF-01T-P1.3E SLM-01T-P1.3E	--	YC-202	YRM-201	--	--	--	WC-202	LLF/M-01T-P1.3E	LEJ-13	LIT-2013
SLF-41T-P1.3E SLM-41T-P1.3E	--	YC-203	--	--	--	--	WC-203	LLF/M-41T-P1.3E	LEJ-13	--
SMF-01T-1.0	--	YC-081	--	--	--	--	--	LMF-01T-1.0	--	--
SMF-01T-1.3	--	YC-082	--	--	--	--	--	LMF-01T-1.3	--	--
SMM-003T-P0.5	YRS-800	--	--	--	--	--	WC-800	--	--	--
SMR-001T-0.6	YRS-580	YC-580R	--	--	--	--	--	BMR-001T-0.6	--	--
SOM-21(T)-187	--	YC-680	--	--	--	--	--	LOM-21(T)-187	--	--
SOM-51(T)-250	--	YC-066	--	--	--	--	WC-066	LOM-51(T)-250	--	--
SOTZP-002GD-P0.18	--	--	--	--	--	--	--	--	EJ-OTZS	--

Note: Contact JST for wire range.

Crimping tools

Terminals and parts model number in alphabetical order	Hand tools					Hand tools			Extraction and Insertion tools	
	for chain terminals	for loose piece terminals				for loose piece terminals			Extraction tool	Insertion tool
	YRS series	YC series	YRM series	YRF series	YRK · YRK-EX series	WC & JUC series JUK's Hand Tools	Terminal in loose form model No.			
SPA-001T-P0.5	—	YC-610R YC-611R	—	—	—	—	—	BPA-001T-P0.5	EJ-PH	—
SPAL-001T-P0.5	—	YC-610R YC-611R	—	—	—	—	—	BPAL-001T-P0.5	EJ-PAL	—
SPAL-002T-P0.5	YRS-1340	—	—	—	—	—	—	—	EJ-PAL	—
SPB-1.0-250N-S	—	—	—	—	—	—	JUCS-PB	—	—	—
SPB-2.5-250N-S	—	—	—	—	—	—	JUCS-PB	—	—	—
SPBD-001T-P0.5	—	YC-610R	—	—	—	—	—	—	—	—
SPBD-002T-P0.5	—	YC-611R	—	—	—	—	—	—	—	—
SPF-01T-2.5C	—	YC-043R	—	—	—	—	—	LPF-01T-2.5C	—	—
SPH-001T-P0.5L	YRS-245	—	—	—	—	—	—	—	—	—
SPH-002T-P0.5L	YRS-241	—	—	—	—	—	—	—	EJ-PH	—
SPH-002T-P0.5S	YRS-240	—	YRM-240	—	—	—	WC-240	BPH-002T-P0.5S	EJ-PH	—
SPH-004T-P0.5S	YRS-243	—	—	—	—	—	—	—	EJ-PH	—
SPHD-001T-P0.5	—	YC-610R YC-611R	—	—	—	—	WC-610	BPHD-001T-P0.5	EJ-PHD-RB	—
SPHD-002T-P0.5	YRS-620	—	YRM-620	—	—	—	WC-620	BPHD-002T-P0.5	EJ-PHD-RB	—
SPID-001T-P0.5	YRS-1620	—	—	—	—	—	—	—	EJ-PID	—
SPLI-002T-P0.5	YRS-1410	—	—	—	—	—	—	—	—	—
SPND-001T-C0.5	YRS-1091	—	—	—	—	—	—	—	EJ-PND	—
SPND-002T-C0.5	YRS-1090	—	—	—	—	—	—	—	EJ-PND	—
SPNI-001T-P0.5	—	YC-610R YC-611R	—	—	—	—	—	—	—	—
SPNI-002T-P0.5	YRS-1340	—	—	—	—	—	—	—	—	—
SPS-01T-110	—	YC-740	—	—	—	—	WC-740	LPS-01T-110	—	—
SPS-01T-187(-8)	—	YC-730 YC-731	—	—	—	—	WC-730	LPS-01T-187(-8)	EJ-PS187	—
SPS-21T-205(-5)	—	YC-760	—	—	—	—	—	LPS-21T-205(-5)	—	—
SPS-21T-250	—	YC-780	—	—	—	—	WC-780	LPS-21T-250	EJ-PS250	—
SPS-21T-250S	—	YC-780	—	—	—	—	WC-780	LPS-21T-250S	EJ-PS250	—
SPS-21T-250R	—	YC-780	—	—	—	—	—	LPS-21T-250R	EJ-PS250	—
SPS-41T-110	—	YC-750 YC-751	—	—	—	—	WC-750	LPS-41T-110	—	—
SPS-51T-187(-8)	—	YC-710 YC-711	—	—	—	—	WC-710	LPS-51T-187(-8)	EJ-PS187	—
SPS-51T-205	—	YC-770 YC-771	—	—	—	—	—	LPS-51T-205	—	—
SPS-61T-250	—	YC-720	—	—	—	—	WC-720	LPS-61T-250	EJ-PS250	—
SPS-61T-250S	—	YC-720	—	—	—	—	—	LPS-61T-250S	EJ-PS250	—
SPS-61T-250R	—	YC-721	—	—	—	—	—	LPS-61T-250R	EJ-PS250	—
SPS-91T-250	—	—	—	YRF-790	—	—	—	BPS-91T-250	EJ-PS250	—
SPS-91T-250S	—	—	—	YRF-790	—	—	—	BPS-91T-250S	EJ-PS250	—
SPS-91T-250R	—	—	—	YRF-791	—	—	—	BPS-91T-250R	EJ-PS250	—
SPSI-001T-M1.1	—	YC-335R	—	—	—	—	—	—	EJ-PSIP	—
SPSM-001T-M1.1	—	YC-335R	—	—	—	—	—	—	EJ-PSIR	—
SPSI-41T-M1.1	—	YC-225R	—	—	—	—	—	—	EJ-PSIP	—
SPSM-41T-M1.1	—	YC-226R	—	—	—	—	—	—	EJ-PSIR	—
SPUD-001T-P0.5	YRS-1320	—	—	—	—	—	—	—	EJ-PUD	—
SPUD-002T-P0.5	YRS-1520	—	—	—	—	—	—	—	EJ-PUD	—

Note: Contact JST for wire range.

Crimping tools

Terminals and parts model number in alphabetical order	Hand tools					Hand tools			Extraction and Insertion tools	
	for chain terminals	for loose piece terminals				for loose piece terminals			Extraction tool	Insertion tool
	YRS series	YC series	YRM series	YRF series	YRK · YRK-EX series	WC & JUC series JUK's Hand Tools	Terminal in loose form model No.			
SPXA-001T-P0.6	--	--	--	--	--	--	--	--	EJ-PXA	--
SRA-20(T)**	--	YC-181	--	--	--	--	--	LRA-20(T)**	--	--
SRA-21(T)**	--	YC-141	--	--	--	--	--	LRA-21(T)**	--	--
SRA-50(T)**	--	YC-182	--	--	--	--	--	LRA-50(T)**	--	--
SRA-51(T)**	--	YC-142	--	--	--	--	--	LRA-51(T)**	--	--
SRB-1.0( )	--	--	--	--	--	JUCS-RB/RT	--	--	--	--
SRB-2.5( )	--	--	--	--	--	JUCS-RB/RT	--	--	--	--
SRB-51(T)**	--	YC-142	--	--	--	--	--	LRB-51(T)**	--	--
SRC-01(T)**	--	YC-033	--	--	--	--	--	LRC-01(T)**	--	--
SRC-50(T)**	--	YC-183	--	--	--	--	--	LRC-50(T)**	--	--
SRC-51(T)**	--	YC-142	--	--	--	--	--	LRC-51(T)**	--	--
SRF-51(T)**	--	YC-142	--	--	--	--	--	LRF-51(T)**	--	--
SRFCP-002GG-M0.9	YRS-1530 YRS-1531	--	--	--	--	--	--	--	EJ-RFC-P	--
SRFF-01GG-S0.9	--	--	--	--	--	--	--	--	EJ-RFC-R	--
SRFF-61GG-S0.9	--	--	--	YRF-1450	--	--	--	--	EJ-RFC-R	--
SRFM-01GG-S0.9	--	--	--	--	--	--	--	--	EJ-RPZ	--
SRFM-61GG-S0.9	--	--	--	YRF-1450	--	--	--	--	EJ-RPZ	--
SRICM-61GG-S0.6	--	YC-840R	--	--	--	--	--	--	--	--
SRICM-61T-S0.6	--	--	--	--	--	--	--	--	--	--
SRT-1.0( )	--	--	--	--	--	JUCS-RB/RT	--	--	--	--
SRT-2.5( )	--	--	--	--	--	JUCS-RB/RT	--	--	--	--
SRT-51T**	--	YC-143R	--	--	--	--	--	LRT-51T**	--	--
SRWF-01GG-M0.6	--	--	--	--	--	--	--	--	EJ-RPZ	--
SRWF-01T-M0.6	--	--	--	--	--	--	--	--	--	--
SRWM-01GG-S0.6	--	--	--	--	--	--	--	--	EJ-RPZ	--
SRWF-21GG-M0.6	--	--	--	--	--	--	--	--	EJ-RPZ	--
SRWF-21GG-S0.6	--	--	--	--	--	--	--	--	--	--
SRWF-61GG-M0.6	--	YC-840R	--	--	--	--	--	BRWF-61GG-M0.6 BRWM-61GG-S0.6	EJ-RPZ	--
SRWF-61T-M0.6	--	--	--	--	--	--	--	--	--	--
SRWM-61GG-S0.6	--	--	--	--	--	--	--	--	--	--
SSFH-001T-P0.5	YRS-1580 YRS-1581	--	--	--	--	--	--	--	EJ-SFH	--
SSFH-002T-P0.5	YRS-1490	--	--	--	--	--	--	--	EJ-SFH	--
SSH-003T-P0.2-H	YRS-859	--	--	--	--	WC-SH2832	--	--	--	--
SSH-003GA-P0.2	YRS-859	--	--	--	--	WC-SH2832	--	--	--	--
SSHJ-003T-P0.2	YRS-859	--	--	--	--	--	--	--	--	--
SSHL-002T-P0.2	YRS-1590	--	--	--	--	WC-GH2630	--	--	--	--
SSHL-003T-P0.2	YRS-859	--	--	--	--	WC-SH2832	--	--	--	--
SSHL-003GA1-P0.2	YRS-859	--	--	--	--	WC-SH2832	--	--	--	--
SSF-01T-P1.4	--	YC-500	--	--	--	--	--	BSF/M-01T-P1.4	SLJ-1.4	ITBL-08V
SSM-01T-P1.4	--	--	--	--	--	--	--	--	--	--
SSF-21T-P1.4	--	YC-550	--	--	--	WC-550	--	BSF/M-21T-P1.4	SLJ-1.4	--
SSM-21T-P1.4	--	--	--	--	--	--	--	--	--	--
STI-01(T)-110N	--	YC-041	--	--	--	--	--	LTI-01(T)-110N	--	--
STI-1.0-250D/N	--	--	--	--	--	JUCS-TI	--	--	--	--
STI-2.5-250D/N	--	--	--	--	--	JUCS-TI	--	--	--	--
STI-41(T)-110N	--	YC-063	--	--	--	--	--	LTI-41(T)-110N	--	--
STI-51(T)-250N	--	YC-322	--	--	--	--	--	LTI-51(T)-250N	--	--
STO-01(T)-110N(-8)	--	YC-041	--	--	--	--	--	LTO-01(T)-110N(-8)	--	--
STO-01(T)-187N(-8)	--	YC-042	--	--	--	--	--	LTO-01(T)-187N(-8)	--	--

Note: Contact JST for wire range.



Crimping tools

Terminals and parts model number in alphabetical order	Hand tools					Hand tools		Extraction and Insertion tools	
	for chain terminals	for loose piece terminals				for loose piece terminals		Extraction tool	Insertion tool
	YRS series	YC series	YRM series	YRF series	YRK · YRK-EX series	WC & JUC series JUK's Hand Tools	Terminal in loose form model No.		
STO-0.25-110N	--	YC-810	--	--	--	--	--	--	--
STO-0.5-110N	--	YC-820	--	--	--	JUCS-05110	--	--	--
STO-1.0-110N	--	--	--	--	--	JUCS-2.8/4.8	--	--	--
STO-1.0-187N	--	--	--	--	--	JUCS-2.8/4.8	--	--	--
STO-1.0-250N	--	--	--	--	--	JUCS-6.3	--	--	--
STO-2.5-250N	--	--	--	--	--	JUCS-6.3	--	--	--
STO-21(T)-205N(-5)	--	YC-053	--	--	--	--	LTO-21(T)-205N	--	--
STO-21(T)-250N	--	YC-102	--	--	--	--	LTO-21(T)-250N	--	--
STO-41(T)-110N(-8)	--	YC-062	--	--	--	--	LTO-41(T)-110N(-8)	--	--
STO-41(T)-187N(-8)	--	YC-051	--	--	--	--	LTO-41(T)-187N(-8)	--	--
STO-41T-187S	--	YC-064	--	--	--	--	LTO-41T-187S	EJ-187S	--
STO-61(T)-250N	--	YC-047	--	--	--	--	LTO-61(T)-250N	--	--
STO-81(T)-250N	--	YC-280	--	YRF-280	--	--	LTO-81(T)-250N	--	--
STS-002GG-P0.6 STSD-002GG-P0.6	YRS-1360	--	--	--	--	--	--	EJ-TSD	--
SVA-41T-P1.1	--	YC-450	--	--	--	--	BVA-41T-P1.1	--	--
SVF-01T-1.5A	--	YC-044	--	--	--	--	LVF-01T-1.5A	--	--
SVF-01T-1.5N	--	YC-151	--	--	--	--	LVF-01T-1.5N	EJ-SV	--
SVF-01T-2.36N	--	YC-152	--	--	--	--	LVF-01T-2.36N	EJ-LV	--
SVF-42T-P2.0	--	YC-592	--	--	--	WC-592	BVF-42T-P2.0	VLJ-20	--
SVM-42T-P2.0	--	YC-593	--	--	--	WC-592	BVM-42T-P2.0	VLJ-20	--
SVF-61T-P0.2 SVM-61T-P0.2	--	YC-590	--	YRF-590	--	WC-590	BVF/M-61T-P2.0	VLJ-20	--
SVF-81T-P0.2 SVM-81T-P0.2	--	--	--	YRF-591	--	WC-591	BVF/M-81T-P2.0	VLJ-20	--
SVH-21T-P1.1	--	YC-160R YC-161R YC-164R	YRM-160 -- YRM-164	--	--	WC-160	BVH-21T-(P)1.1	EJ-NV	--
SVH-41T-P1.1	--	YC-930R YC-931R	--	--	--	WC-930	BVH-41T-P1.1	EJ-NV	--
SVSF-61T-S2.0 SVSM-61T-S2.0	--	--	--	YRF-590	--	--	--	VLJ-20	--
SVSF-81T-S2.0 SVSM-81T-S2.0	--	--	--	YRF-591	--	--	--	VLJ-20	--
SVT-41T-P1.1	--	YC-630	--	--	--	--	BVT-41T-P1.1	EJ-VT	--
SVU-21T-P0.6	--	YC-990R	--	--	--	--	BVU-21T-P0.6	EJ-VU	--
SVYF-61T-P0.5A	--	--	--	YRF-536	--	--	--	--	--
SWPJT-21T-P0.5	--	--	--	--	--	--	--	EJ-WPJ	--
SWPJT-21T-P0.5A	--	--	--	--	--	--	--	EJ-WPJ	--
SWPJR-21T-M0.5	--	--	--	--	--	--	--	EJ-WPJ	--
SWPKP-21T-0.6	--	--	--	YRF-1051	--	--	BWPKP-21T-0.6	--	--
SWPKR-21T-0.6	--	--	--	YRF-1050	--	--	BWPKR-21T-0.6	--	--
SWPR-001T-P025 SWPT-001T-P025	YRS-980	--	--	--	--	WC-JWPF	--	EJ-JWPF	--
SXA-01T-P0.6	YRS-701	YC-701R	--	--	--	WC-700M	BXA-01T-P0.6	EJ-XAG, EJ-XMP	--
SXA-001T-P0.6	YRS-692	YC-692R	--	--	--	--	BXA-001T-P0.6	EJ-XMP, EJ-XMR	IT-XA
SXA-001T-P0.6L	YRS-691	--	--	--	--	WC-691	--	--	--

Note: Contact JST for wire range.

Crimping tools

Terminals and parts model number in alphabetical order	Hand tools					Hand tools			Extraction and Insertion tools	
	for chain terminals	for loose piece terminals				for loose piece terminals			Extraction tool	Insertion tool
	YRS series	YC series	YRM series	YRF series	YRK · YRK-EX series	WC & JUC series JUK's Hand Tools	Terminal in loose form model No.			
SXAM-01T-P0.6	YRS-701	YC-701R	—	—	—	WC-700M	BXAM-01T-P0.6	EJ-XAW	—	
SXAM-001T-P0.6	YRS-692	YC-692R	—	—	—	—	BXAM-001T-P0.6	EJ-XAW	—	
SXF-01T-P0.7	—	YC-251	—	—	—	—	BXF-01T-(P)0.7	LEJ-7	—	
SXF-41T-P0.7	—	YC-252	—	—	—	—	BXF-41T-(P)0.7	LEJ-7	—	
SXH-001T-P0.6	YRS-110	YC-110R YC-111R	—	—	—	WC-110	BXH-001T-P0.6	XJ-06	—	
SXH-001T-P0.6N	—	—	—	—	—	—	—	XJ-06	—	
SXH-002T-P0.6	YRS-480	—	—	—	—	—	—	XJ-06	—	
SXM-01T-P0.6	YRS-701	YC-701R	—	—	—	—	BXM-01T-P0.6	EJ-XAG, EJ-XMP	—	
SXM-001T-P0.6	YRS-692	YC-692R	—	—	—	—	BXM-001T-P0.6	EJ-XMP, EJ-XMR	IT-XA	
SXNI-001T-P0.6	YRS-1380	—	—	—	—	—	—	—	—	
SXNI-003T-P0.6	YRS-1390	—	—	—	—	—	—	—	—	
SYF-001T-P0.6	YRS-125	—	—	—	—	—	—	—	—	
SYF-01T-P0.5A	—	YC-520	—	—	—	WC-520	BYF-01T-P0.5A BYM-01T-P0.5A	YLJ-0.5	—	
SYF-41T-P0.5A	—	YC-530	—	—	—	WC-530	BYF-41T-P0.5A BYM-41T-P0.5A	YLJ-0.5	—	
SYF-61T-P0.5A	—	—	—	YRF-536	—	—	—	—	—	
SYM-001T-P0.6	YRS-121	YC-121R	—	—	—	WC-121	BYM-001T-P0.6	SMJ-06	—	
SYM-01T-P0.7	—	YC-251	—	—	—	—	BYM-01T-(P)0.7	LEJ-7	—	
SYM-41T-P0.7	—	YC-252	—	—	—	—	BYM-41T-(P)0.7	LEJ-7	—	
SZE-002T-P0.3	YRS-1460	—	—	—	—	—	—	—	—	
SZE-003T-P0.3	YRS-1330	—	—	—	—	—	—	—	—	
SZF-01T-P0.7	—	YC-390R	—	—	—	—	BZF-01T-(P)0.7 BZM-01T-(P)0.7	ZLJ-0.7S	—	
SZF-41T-P0.7	—	YC-380R	—	—	—	—	BZF-41T-(P)0.7 BZM-41T-(P)0.7	ZLJ-0.7S	—	
SZH-002T-P0.5	YRS-491	—	—	—	—	WC-491	—	—	—	
SZH-003T-P0.5	YRS-490	—	—	—	—	WC-490	—	—	—	
SZN-002T-P0.7K	YRS-541	—	—	—	—	—	—	—	—	
SZN-003T-P0.7K	YRS-540	—	—	—	—	—	—	—	—	
SZND-002T-P0.5	YRS-1710	—	—	—	—	—	—	—	—	
SZPD-002T-P0.3	YRS-1460	—	—	—	—	—	—	—	—	

Note : Contact JST for wire range.



**YRK series hand crimping tools suitable for mass-production**

- Crimping work, such as setting contacts to hand tools etc., is facilitated by using a strip contact to improve the productivity.
- A light operation enables to terminate the contact correctly, by adopting straight-ahead crimping.
- A structure, that the carrier of contact doesn't fly off, has been adopted to this tool.

**Hand Crimping Tools**

**YRK Standard type**

- When exchanging the crimper, the crimping suitable for the wire specification can be conducted.
- Anvil is fixed to tool.



Dimensions: 75(W)×314(L)×25(D) mm  
Weight: Approx. 800 g (When assembling dies)

**Contact and Applicable dies**

Series	Nominal	Contact Model No.		Hand crimp tools	Model No. of crimper <sup>*1</sup>	Applicable wire size		
		Receptacle	Tab			Marking	AWG	Insulation O.D. (mm)
J1000	M	SF1F-002(*)-P0.6	SF1M-002(*)-M0.6A	YRK-1220	MA / MB	MA	#28	φ 1.20
						MB	#24	φ 1.43
	ME	SF1F-01GC-P0.6	SF1M-01GC-M0.6A	YRK-1230	MEA / MEB MEC / MED	MEA	#24	φ 1.43
						MEB	#20	φ 1.76
						MEC	#22	φ 1.58
						MED	#22	φ 1.36 <sup>*5</sup>
L	SF1F-21(*)-P0.6	SF1M-21(*)-M0.6A	YRK-1210	LA / LB LC / LD	LA	#22	φ 1.58	
					LB	KV0.75	φ 1.90	
					LC	#20	φ 1.76	
					LD	#18	φ 2.03	
J2000	S	SJ2F-002(*)-P1.0	SJ2M-002(*)-M1.0N	YRK-8852	SA / SB SC / SD	SA	#28	φ 1.20
						SB	#24	φ 1.43
						SD	#24	φ 1.11 <sup>*3</sup>
	M	SJ2F-01(*)-P1.0	SJ2M-01(*)-M1.0N SJ2M-01(*)-M1.0S	YRK-8863	MA / MB MC / MD	MA	#24	φ 1.43
						MB	#20	φ 1.53 <sup>*2</sup>
						MD	#22	φ 1.26 <sup>*3</sup>
J300	L	SJ2F-21(*)-P1.0	SJ2M-21(*)-M1.0N SJ2M-21(*)-M1.0S	YRK-1120	LA / LB	LA	#22	φ 1.58
						LB	#20	φ 1.76
	S	SF3F-002(*)-P2.0	SF3M-002(*)-M2.0N	YRK-8821	SA / SB SC / SD	SA	#28	φ 1.20
						SB	#24	φ 1.43
						SD	#24	φ 1.11
	M	SF3F-01(*)-P2.0	SF3M-01(*)-M2.0N	YRK-8811	MA / MB MC / MD	MA	#24	φ 1.43
MB						#20	φ 1.76	
MD						#22	φ 1.58	
L	SF3F-41(*)-P2.0	SF3M-41(*)-M2.0N	YRK-8801	LA / LB LC / LD	LA	#20	φ 1.76	
					LB	#16	φ 2.35	
					LC	#18	φ 2.03	
					LD	#18	φ 2.83 <sup>*4</sup>	
2L	SF3F-71(*)-P2.0	SF3M-71(*)-M2.0N	YRK-1071	2LA / 2LB	2LA	#16	φ 3.10 <sup>*4</sup>	
					2LB	KIV2.0	φ 3.30	

Note: 1. Surface Finish(\*) GC...Nickel-undercoated, 0.2μm selective gold-plated  
GF...Nickel-undercoated, 0.38μm selective gold-plated  
GFA...Nickel-undercoated, 0.38μm selective gold-plated (A type)  
GI...Nickel-undercoated, 0.76μm selective gold-plated  
GIA...Nickel-undercoated, 0.76μm selective gold-plated (A type)  
T...Tin-plated (reflow treatment)

\*1... Crimper is either the pair of A and B or the pair of C and D.  
\*2... When using wire type UL 2517.  
\*3... When using wire type 1061  
\*4... When using wire type 1015  
\*5... When using wire type 10442

2. The wear of parts is caused by using hand tool repeatedly.  
Measure the crimping height daily and conduct periodical inspection of the wearing parts, such as ratchet, pin and so on.

**Dies replacement type hand crimping tools**

**YRK-EX**

- High reliability of crimping is provided by choosing the crimper and anvil suitable for the wire specification.
- The crimping die can be easily exchanged by only insertion and extraction of pin.
- Common handle and crimping dies can be stored in One case and it is easy to carry.

Patent pending

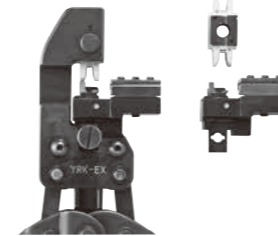

Dimensions: 75(W)×314(L)×25(D) mm  
Weight: Approx. 800 g (When assembling dies)



Dimensions: 376×295(L)×73(D) mm

**Contact and Applicable dies**

Series	Nominal	Contact Model No.		Crimper Model No.	Crimper <sup>*1</sup>			Anvil	Color mark	Common parts
		Receptacle	Tab		Applicable wire size					
					Die mark	AWG	Insulation O.D. (mm)			
J1000	M	SF1F-002(*)-M0.6A	SF1M-002(*)-M0.6A	J1MA / B J1MC / D	J1MA	#28	φ 1.20	J1ML	Gold	Handle unit Upper pin Lower pin Case
					J1MB	#24	φ 1.43			
					J1MC	#26	φ 1.30			
	L	SF1F-21(*)-P0.6	SF1M-21(*)-M0.6A	J1LA / B J1LC / D	J1MD	#24	φ 1.11	J1LL	Yellow green	
					J1LA	#20	φ 1.76			
					J1LB	#18	φ 2.03			
J2000	S	SJ2F-002(*)-P1.0	SJ2M-002(*)-M1.0N	J2SA / B J2SC / D	J2SA	#28	φ 1.20	J2SL	White	
					J2SB	#24	φ 1.43			
					J2SC	#26	φ 1.30			
	M	SJ2F-01(*)-P1.0	SJ2M-01(*)-M1.0N SJ2M-01(*)-M1.0S	J2MA / B J2MC / D	J2SD	#24	φ 1.11 <sup>*3</sup>	J2ML	Purple	
					J2MA	#24	φ 1.43			
					J2MB	#20	φ 1.53 <sup>*2</sup>			
L	SJ2F-21(*)-P1.0	SJ2M-21(*)-M1.0N SJ2M-21(*)-M1.0S	J2LA / B	J2MC	#24	φ 1.11 <sup>*3</sup>	J2LL	Orange		
				J2MD	#22	φ 1.26 <sup>*3</sup>				
				J2LA	#22	φ 1.58				
J300	S	SF3F-002(*)-P2.0	SF3M-002(*)-M2.0N	J3SA / B J3SC / D	J3SA	#28	φ 1.20	J3SL	Yellow	
					J3SB	#24	φ 1.43			
					J3SC	#26	φ 1.30			
	M	SF3F-01(*)-P2.0	SF3M-01(*)-M2.0N	J3MA / B J3MC / D	J3SD	#24	φ 1.11	J3ML	Green	
					J3MA	#24	φ 1.43			
					J3MB	#20	φ 1.76			
L	SF3F-41(*)-P2.0	SF3M-41(*)-M2.0N	J3LA / B J3LC / D	J3MC	#22	φ 1.58	J3LL	Red		
				J3MD	#20	φ 2.56 <sup>*4</sup>				
				J3LA	#20	φ 1.76				
2L	SF3F-71(*)-P2.0	SF3M-71(*)-M2.0N	J32LA / B	J3LB	#16	φ 2.35	J32LL	Blue		
				J3LC	#18	φ 2.03				
				J3LD	#18	φ 2.83 <sup>*4</sup>				
					J32LA	#16	φ 3.10 <sup>*4</sup>			
					J32LB	KIV2.0	φ 3.30			

Note: 1. Surface Finish(\*) : GC...Nickel-undercoated, 0.2μm selective gold plated  
GF...Nickel-undercoated, 0.38μm selective gold-plated  
GFA...Nickel-undercoated, 0.38μm selective gold-plated (A type)  
GI...Nickel-undercoated, 0.76μm selective gold-plated  
GIA...Nickel-undercoated, 0.76μm selective gold-plated (A type)  
T...Tin-plated

\*1... Crimper is either the pair of A and B or the pair of C and D.  
\*2... When using wire type UL 2517.  
\*3... When using wire type 1061.  
\*4... When using wire type 1015.

2. The wear of parts is caused by using hand tool repeatedly.  
Measure the crimping height daily and conduct periodical inspection of the wearing parts, such as ratchet, pin and so on.

## X-ON Electronics

Largest Supplier of Electrical and Electronic Components

*Click to view similar products for [Crimpers / Crimping Tools](#) category:*

*Click to view products by [JST manufacturer](#):*

Other Similar products are found below :

[010-0096](#) [M225201-06](#) [M225202-37](#) [6-1579015-5](#) [CT150-2-D02](#) [CT150-6-RH07](#) [622-6441LF](#) [M322](#) [6-304052-1](#) [63456-0054](#) [63484-3701](#)  
[63800-8355](#) [63819-1875](#) [63819-2875](#) [63819-4475](#) [63823-3475](#) [63827-5375](#) [64001-0975](#) [64001-4175](#) [64005-0175](#) [662903-2](#) [690602-6](#) [7-](#)  
[1579001-9](#) [7-23471-1](#) [762637-1](#) [808714-1](#) [811242-5](#) [91362-1](#) [999-50-020083](#) [1-21002-3](#) [1-21002-7](#) [12085270](#) [1-21002-6](#) [1-21113-6](#) [1-](#)  
[22548-4](#) [125442-1](#) [DCE.91.073.BVC](#) [DCE.91.090.3MVM](#) [DCE.91.130.5MVU](#) [DCE.91.202.BVCM](#) [1338300-1](#) [1-354003-0](#) [1338301-1](#)  
[142321](#) [AP105-DF11-2428S\(64\)](#) [1456088-1](#) [1490794-1](#) [1-45804-6](#) [1490357-2](#) [1490357-3](#)