

FPC 1.0mm间距 18P 抽拉式 上接

NOTES:

- 1.MATERIAL:
HOUSING:NYLON UL94V-0
LATCH:PPS UL94V-0
TERMINAL:COPPER ALLOY
FITTING NAIL:COPPER ALLOY
- 2.PLATING:Sn/Pb OVER Ni.
- 3.COPLANARITY 0.1 MM MAX. BASE ON DATUM A
- 4.TRUE POSITION 0.1 MM MAX. BAES ON DATUM B

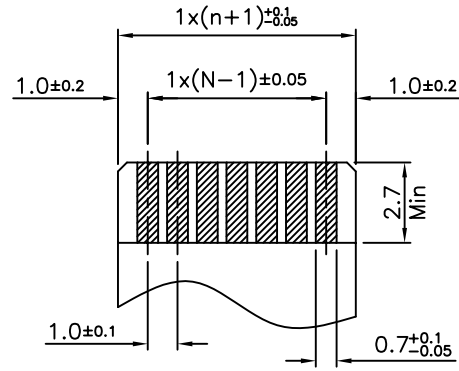

APPLICABLE FPC
RECOMMENDED DIMENSION
(THICKNESS:0.3±0.05)

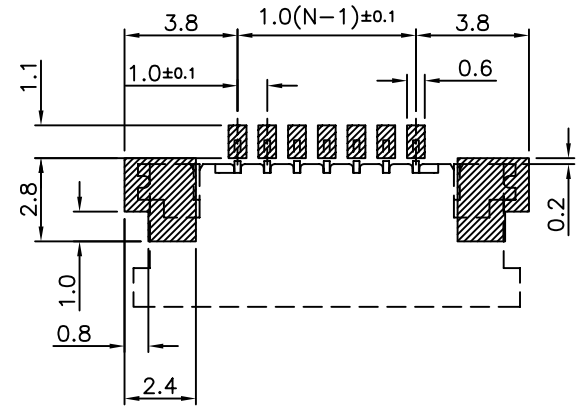
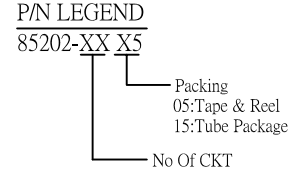

PCB PATTERN LAYOUT

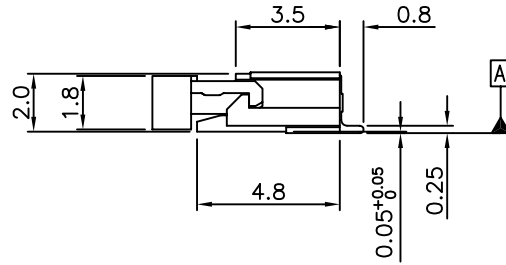
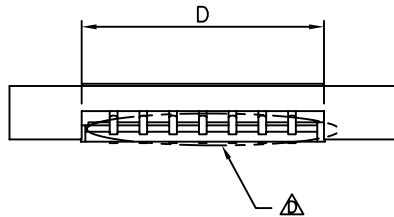
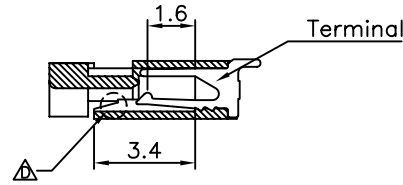
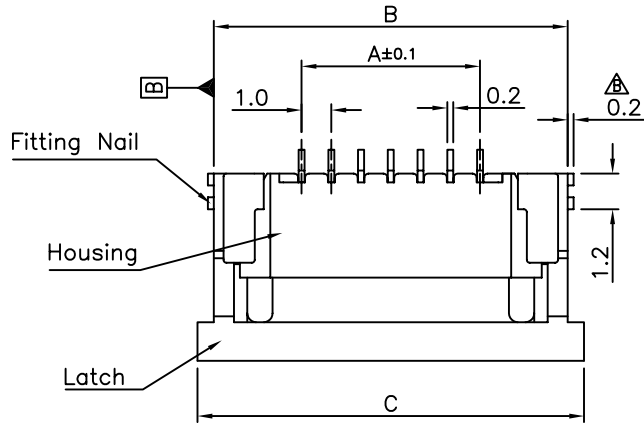

CKT	Dim A	Dim B	Dim C	Dim D	CKT	Dim A	Dim B	Dim C	Dim D
3	2.0	7.9	9.0	4.15	18	17.0	22.9	24.0	19.15
4	3.0	8.9	10.0	5.15	19	18.0	23.9	25.0	20.15
5	4.0	9.9	11.0	6.15	20	19.0	24.9	26.0	21.15
6	5.0	10.9	12.0	7.15	21	20.0	25.9	27.0	22.15
7	6.0	11.9	13.0	8.15	22	21.0	26.9	28.0	23.15
8	7.0	12.9	14.0	9.15	23	22.0	27.9	29.0	24.15
9	8.0	13.9	15.0	10.15	24	23.0	28.9	30.0	25.15
10	9.0	14.9	16.0	11.15	25	24.0	29.9	31.0	26.15
11	10.0	15.9	17.0	12.15	26	25.0	30.9	32.0	27.15
12	11.0	16.9	18.0	13.15	27	26.0	31.9	33.0	28.15
13	12.0	17.9	19.0	14.15	28	27.0	32.9	34.0	29.15
14	13.0	18.9	20.0	15.15	29	28.0	33.9	35.0	30.15
15	14.0	19.9	21.0	16.15	30	29.0	34.9	36.0	31.15
16	15.0	20.9	22.0	17.15	31	30.0	35.9	37.0	32.15
17	16.0	21.9	23.0	18.15	32	31.0	36.9	38.0	33.15

一般公差
TOLERANCES
X ±0.5 XX ±0.15
Y ±0.25 XXX ±0.1
ANGLES ±2°

宏致電子股份有限公司
Aces Electronic Co.,Ltd.

REV	REVISION DESCRIPTION	DATE	SIGNATURE
D	For ECN-BMR056 (增加柵欄高)	'04/04/21	Ling
C	膠體修改 1.0 PITCH(PECR-A00106)	'03/7/26	蔡文華
B	變更鐵耳尺寸	'01/01/19	Grace
A	變更鐵耳	'01/01/05	Grace
0	新圖製成	'00/06/08	Grace

材質 (MAT'L)	SEE NOTES	品名 (TITLE)	1.0mm ZIF FPC CONN.	製圖 (DR)	GRACE
組件 (NEXT ASS'Y)	-	SMT R/A BOTTOM CONTACT TYPE	-	'00/06/08	審核 (CHKD)
圖號 (DWG.NO)	85202-XXX5	圖號 (DWG.NO)	85202-XXX5	核准 (APPD)	Derrick
表面處理 (FINISH)	-	比例 (SCALE)	4:1	單位 (UNITS)	mm
張數 (SHEET)	1 OF 1	尺寸 (SIZE)	A4	REV	D

X-ON Electronics

Largest Supplier of Electrical and Electronic Components

Click to view similar products for [FFC & FPC Connectors](#) category:

Click to view products by [JUSHUO](#) manufacturer:

Other Similar products are found below :

[00-6200-227-022-800](#) [006205250500825+](#) [006205280500825+](#) [FPH-1422G](#) [FPH-1602G](#) [FPH-2022G](#) [52610-1075](#) [52610-1275](#) [52610-1934](#)
[501864-3091-TR225](#) [086222026001800](#) [52610-0675](#) [62674-201121DLF](#) [62684-36210E9ALF](#) [52746-1671-TR250](#) [10051922-2810EHLF](#) [6-](#)
[520415-9](#) [686322124422](#) [XF3M-2915-1B-R100](#) [AYF353125A](#) [AYF530665TA](#) [AYF534065TA](#) [AYF351525](#) [086212040340800+](#)
[AYF530365TA](#) [67000-004LF](#) [006207341915000+](#) [207356-1](#) [67000-003LF](#) [HFW14R-2STE9LF](#) [SFW12R-5STE9LF](#) [SFW18R-1STAE9LF](#)
[SFW4R-5STE9LF](#) [52807-0430](#) [046283021002868+](#) [502250-8027](#) [104267-9617](#) [66987-011LF](#) [HFW8S-2STAE1HLF](#) [67000-008LF](#)
[HFW22R-2STE1H1LF](#) [0781271110](#) [5019511030](#) [200528-0260](#) [5039084120](#) [503908-5120](#) [SFW20R-1STGE5LF](#) [FH12-18S-0.5SH](#)
[686116183522](#) [FH64MA-11S-0.25SHW](#)