

深圳市钜硕电子有限公司  
SHENZHEN JUSHUO ELECTRONIC CO.,LTD

产 品 承 認 書  
Product acknowledgment

客户 (Customer) :

品名 (Product Name) : 0.8mm间距卧式贴片连接器

料号 (Material number) : AFC08-S\*\*QCA-00 (\*\*表示PIN位数)

本公司确认Our confirmation		
工程/日期engineering/date	业务/日期business/date	批准/日期Approval/date
刘中华 2019.08.11	王 斌 2019.08.11	幸坤新 2019.08.11
客户确认Customer confirmation		
工程/日期engineering/date	品质/日期quality/date	批准/日期Approval/date
公司地址:		
电话:		
联系人:		
传真:		
邮件:		





<b>深圳市钜硕电子有限公司</b> SHENZHEN JUSHUO ELECTRONIC CO.,LTD		产品名称 product name	0.8mm卧式贴片
		产品型号 Product model	AFC08-S**QCA-00
<b>产品承认书</b> <b>Certificate of production</b>		版本号 Version No	1版 1 version
		页码 Page number	共8页 第4页 Page 4 of 8
<b>1. 适用范围 Scope of application</b> 本规范适用于0.8系列产品。 This specification is applicable to A1251 series products.			
<b>2. 标准额定值 Standard rating</b>			
项目 project		规格 specifications	
额定电压 The rated voltage		50V	
额定电流 Rated current		0.5A AC/DC	
使用温度范围 Operating temperature range		-25℃~85℃	
使用湿度范围 Operating humidity range		相对湿度90%以下 Relative humidity is below 90%	
<b>3. 环保 The environmental protection</b> 产品符合ROHS环保要求。 Products in line with ROHS environmental protection requirements.			
<b>4. 包装 Packing</b> 产品内包装为连带，外包装为纸箱，产品在箱内密封，不晃动。 The inner packing of the product is joint and several, the outer packing is carton, the product is sealed in the box, do not shake.			
<b>5. 运输 transport</b> 允许用任何方式运输，但需避免雨雪淋和阳光照射，不能有碰撞和挤压等机械损伤，运输环境温度为-20℃+50℃ It is allowed to be transported by any means, but it should avoid rain, snow and sunlight, no mechanical damage such as collision and extrusion, and the ambient temperature of transportation is -20℃+50℃			
<b>6. 贮存: Storage</b> 包装完毕连接器应在环境温度为-20℃~+50℃，相对湿度不大于90%，周围空气中没有酸性，碱性及其它腐蚀性气体的仓库中贮存。 After packaging, the connector should be in the ambient temperature of -20℃~+50℃, the relative humidity should not be more than 90%, there is no acid, alkaline and other decay in the surrounding air Storage of corrosive gases in a warehouse.			
<b>7. 部件名称/部件规格型号/部件材质 Part name/part specification/part material</b>			
部件名称 Part name	型号 model	材质 The material	
基座 base	0.8	LCP E130i	
插针 pin	0.8	磷铜 Phosphor copper	
固定片 stator	0.8	磷铜 Phosphor copper	
<b>8. 外观及尺寸 Appearance and size</b>			
<b>8.1 外观 appearance</b> 塑胶件表面应无明显疤痕、杂色、开裂、毛刺、飞边、缺料及影响使用的变形；金属件表面应光洁、无锈蚀、氧化、脱皮、发黑及明显的机械损伤等缺陷。 The surface of plastic parts shall be free of obvious scars, mottled, cracked, burr, flash, lack of material and deformation affecting the use; the surface of metal parts shall be smooth and clean No rust, oxidation, peeling, blackening and obvious mechanical damage.			
<b>8.2 尺寸 size</b>			
参照工程图 Reference engineering drawing			

<b>深圳市钜硕电子有限公司</b> SHENZHEN JUSHUO ELECTRONIC CO.,LTD		产品名称 product name	0.8mm卧式贴片
		产品型号 Product model	AFC08-S**QCA-00
<b>产品承认书</b> <b>Certificate of production</b>		版本号 Version No	1版 1 version
		页码 Page number	共8页 第5页 Page 5 of 8
9. 电气特性 Electrical characteristics			
编号 number	项目 project	试验方法 Test method for	性能要求 performance requirement
9.1	接触电阻 contact resistance	将连接器插合，用接触电阻仪进行测试，测量连接器两个端子之间组成一个闭合的回路。 Plug in the connector and test it with a contact resistance meter to measure both terminals of the connector Form a closed loop between.	20mΩ Max
9.2	绝缘电阻 Insulation resistance	将连接器插合，在相邻接触件之间和接触件与外壳之间施加500V DC电压，持续1分钟进行测试。 Plug in the connector and apply 500V DC voltage between the adjacent contacts and between the contacts and the enclosure for 1 minute.	100MΩ Min
9.3	耐电压 Withstand voltage	将连接器插合，在相邻接触件之间和接触件与外壳之间施加500V AC电压，持续1分钟进行测试。 Plug in the connector and apply 500V AC voltage between the adjacent contacts and between the contacts and the enclosure for 1 minute.	无击穿和飞弧现象 No breakdown and flashover
10. 环境特性			
编号 number	项目 project	试验方法 Test method for	性能要求 performance requirement
10.1	耐热试验 Heating test	将插合连接器放在温度为+105℃±2℃的环境中96H，取出放在正常环境中1~2H后再进行测试。 Put the plug connector in the environment of +105℃±2℃ for 96H, take it out and put it in the normal environment for 1~2H before testing.	外观：外观无损伤 Appearance: appearance without damage
			接触电阻：30mΩ Max Contact resistance: 30mΩ Max
10.2	耐冷试验 Cold tolerance test	将插合连接器放在温度为-25℃±2℃的环境中96H，取出放在正常环境中1~2H后再进行测试。 The plug connector was placed in the environment with the temperature of -25℃±2℃ for 96H, and was taken out and placed in the normal environment for 1~2H before being tested.	外观：外观无损伤 Appearance: appearance without damage
			接触电阻：30mΩ Max Contact resistance: 30mΩ Max
10.3	耐湿性试验 Moisture resistance test	将插合连接器放在温度为40℃±2℃，相对湿度90~96%的环境中，持续96H，经试验后，取出放在正常环境中1~2H后再进行测试。 Place the plug connector in an environment with a temperature of 40℃±2℃ and relative humidity of 90~96%.Last for 96H, after the test, take it out and put it in the normal environment for 1~2H before the test.	外观：外观无损伤 Appearance: appearance without damage
			绝缘电阻：50MΩ MIN Insulation resistance: 50MΩ min
			耐电压：300V AC/minute MIN Withstand voltage: 300V AC/minute MIN

<b>深圳市钜硕电子有限公司</b> SHENZHEN JUSHUO ELECTRONIC CO.,LTD		产品名称 product name	0.8mm卧式贴片
		产品型号 Product model	AFC08-S**QCA-00
<b>产品承认书</b> <b>Certificate of production</b>		版本号 Version No	1版 1 version
		页码 Page number	共8页 第6页 Page 6 of 8
编号 number	项目 project	试验方法 Test method for	性能要求 performance requirement
10.4	温度循环 Temperature cycle	<p>把试验样品分别放入高低温试验箱，按下列步骤调试温度：</p> <p>a. 在-25℃±3℃的恒温条件下放置30分钟</p> <p>b. 在常温条件下放置1H</p> <p>c. 在+105℃±3℃的恒温条件下放置30分钟</p> <p>d. 在常温条件下放置1H</p> <p>从a到d为一个循环周期，共进行5个循环，在正常环境中恢复2H后进行检查。</p> <p>Put the test samples into the high and low temperature test chamber, and adjust the temperature according to the following steps:</p> <p>A. Place for 30 minutes under the constant temperature of -25℃±3℃</p> <p>B. Place at room temperature for 1 hour</p> <p>C. Place for 30 minutes at a constant temperature of +105℃±3℃</p> <p>D. Place at room temperature for 1 hour</p> <p>From a to d is a cycle period, a total of 5 cycles are carried out, and 2H is recovered in the normal environment. Check later.</p>	<p>外观：无任何异状</p> <hr/> <p>接触电阻：30mΩ Max Contact resistance: 30mΩ Max</p>
10.5	盐雾试验 Salt Spray Test	<p>将试验样品从试验箱顶悬挂下来，采用浓度为(5±1)%的氯化钠溶液，连续喷雾24H，试验后用流动的蒸溜水轻轻洗去表面沉淀积物，在常温条件下恢复1~2H后再检查测量。</p> <p>The test sample was suspended from the top of the test box, and the concentration of (5±1)% Sodium Chloride Solution was continuously sprayed with 24H. After testing, the surface precipitates were lightly washed with flowing steaming water, then the 1~2H was rechecked at normal temperature.</p>	<p>外观：无损伤、腐蚀（五金件应无露出底金属的严重锈蚀；使用预镀好的型材，其落料面允许有不影响其性能的轻微腐蚀。</p> <p>Appearance: no damage or corrosion (hardware should not expose the bottom metal of serious corrosion: use pre-plating. The blanking surface is allowed to have a slight corrosion that does not affect its performance.</p> <hr/> <p>接触电阻：30mΩ Max Contact resistance: 30mΩ Max</p>

<b>深圳市钜硕电子有限公司</b> SHENZHEN JUSHUO ELECTRONIC CO.,LTD		产品名称 product name	0.8mm卧式贴片
		产品型号 Product model	AFC08-S**QCA-00
<b>产品承认书</b> <b>Certificate of production</b>		版本号 Version No	1版 1 version
		页码 Page number	共8页 第7页 Page 7 of 8
		试验方法 Test method for	性能要求 performance requirement
编号 number	项目 project		
10.6	可焊性 weldability	把试验样品需要焊接的部位浸入245±5℃的锡溶液中，保持2.5±0.5秒。 Dip the welded part of the test sample into 245±5℃ tin solution and hold 2.5±0.5 seconds.	沾锡面积95%以上 Tin area above 95%
10.7	耐焊性 Soldering resistance	将连接器置于PCB板上，然后将产品通过260℃±5℃回流焊或波峰焊5±1S进行测试。 Place the connector on the PCB, and then reflow the product through 260℃±5℃ Or wave soldering for 5±1s.	1. 塑胶件不得有明显变形损坏起泡。 2. 电气特性必须符合规格。 Plastic parts shall be free from obvious deformation, damage and blistering. 2. The electrical characteristics must meet the specifications.

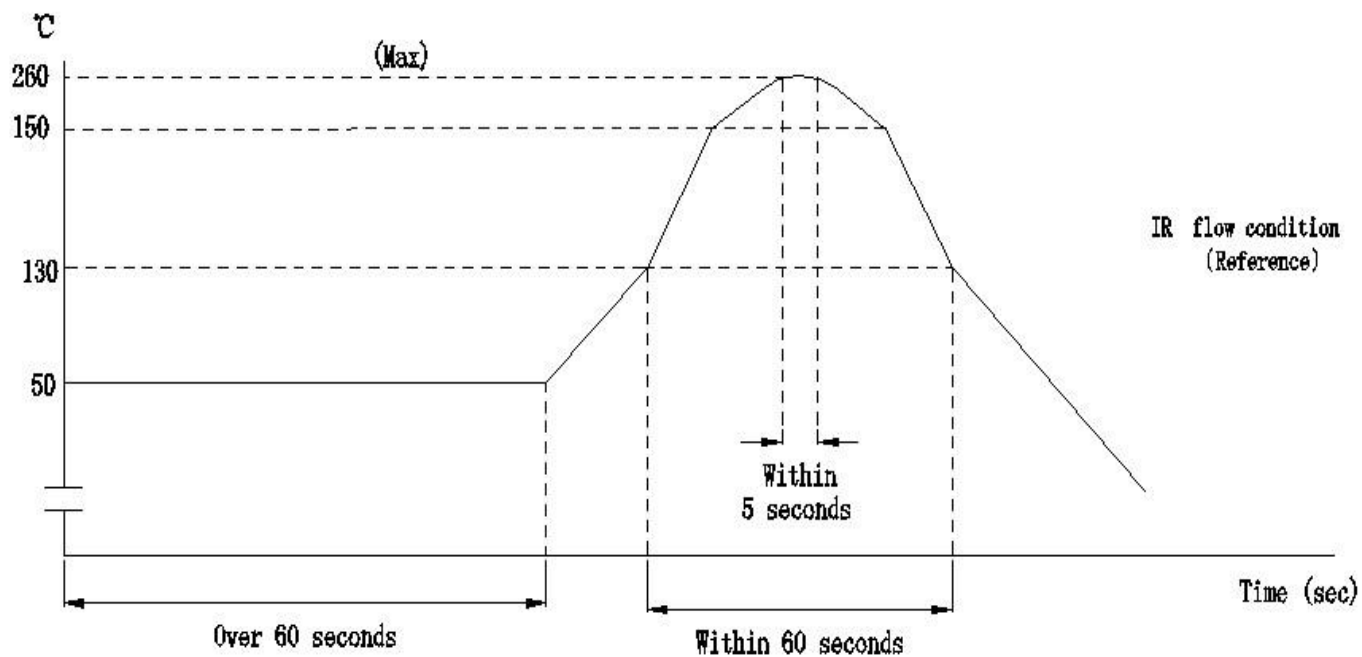

<b>深圳市钜硕电子有限公司</b> SHENZHEN JUSHUO ELECTRONIC CO.,LTD			产品名称 product name	0.8mm卧式贴片			
			产品型号 Product model	AFC08-S**QCA-00			
<b>产品承认书</b> <b>Certificate of production</b>			版本号 Version No	1版 1 version			
			页码 Page number	共8页 第8页 Page 8 of 8			
11. 机械特性 mechanical properties							
编号 number	项目 project	试验方法 Test method for		性能要求 performance requirement			
11.1	PIN针固定力 Pin fixing force	将针座固定在插拔力机上，在针脚前端施加力，以每分钟 $25 \pm 3$ mm的速率，直到针退出针座的拔出力。 Fix the pin holder on the drawing machine and apply force on the front end of the pin at a rate of $25 \pm 3$ mm per minute until the pin is withdrawn from the pin holder.		单一PIN针5N Min Single pin 5n min			
11.2	端子在塑胶件中保持力 Terminal retention in plastic parts	端子与孔座配合，以每分钟 $25 \pm 3$ mm的速率沿导线方向，将端子从孔座中拔出的力。 The terminal shall be matched with the hole seat, and at the rate of $25 \pm 3$ mm per minute along the conductor direction, theThe force that the terminal is pulled out of the socket.		单一端子：5N Min Single terminal: 5n min			
11.3	机械寿命 Mechanical life	无通电状态下，10次/分钟的速度插拔30次。 Under no power on state, plug and unplug 30 times at the speed of 10 times / min.		接触电阻： 30mΩ Max Contact resistance: 30mΩ Max			
11.4	插入力拔出力 Insertion pull out force	试验方法：Test methods (1) 将孔座和端子配合好，与针座在同一轴线上进行插拔测试，测试时需将孔座锁扣去掉。（测试速度： $20 \pm 5$ mm）minute (1) Fit the hole seat and the terminal, and conduct the insertion and removal test on the same axis with the needle seat. Remove the lock of the hole seat (test speed: $20 \pm 5$ mm) minute during the test (2) 性能要求:Performance requirements					
		孔位	插入(N) insert	拔出(N) Pull out	孔位	插入(N) insert	拔出(N) Pull out
		1	3.00	0.50	9	29.00	5.50
		2	8.00	2.00	10	32.00	6.00
		3	11.00	2.50	11	35.00	6.50
		4	14.00	3.00	12	38.00	7.00
		5	17.00	3.50	13	41.00	7.50
		6	20.00	4.00	14	44.00	8.00
		7	23.00	4.50	15	47.00	8.50
		8	26.00	5.00	16	50.00	9.00



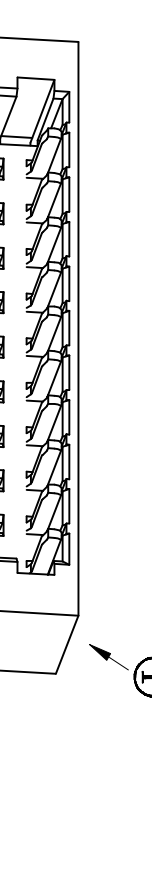
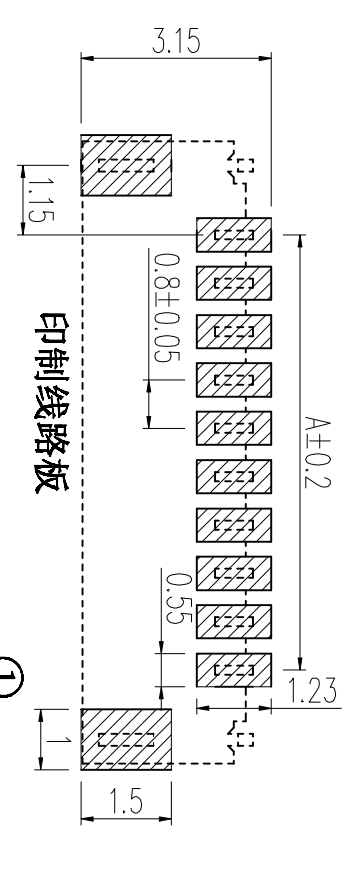
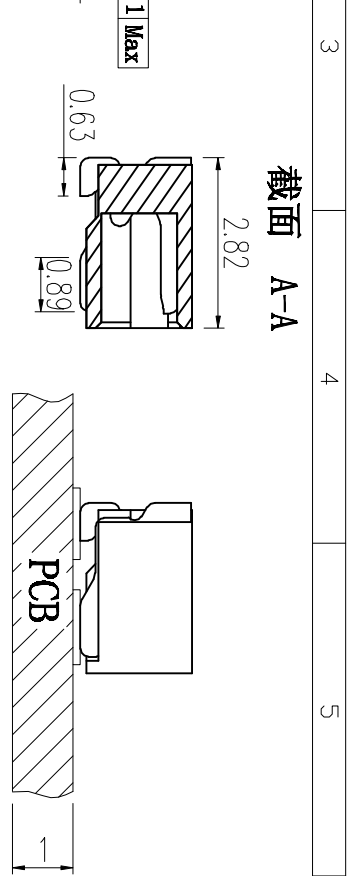
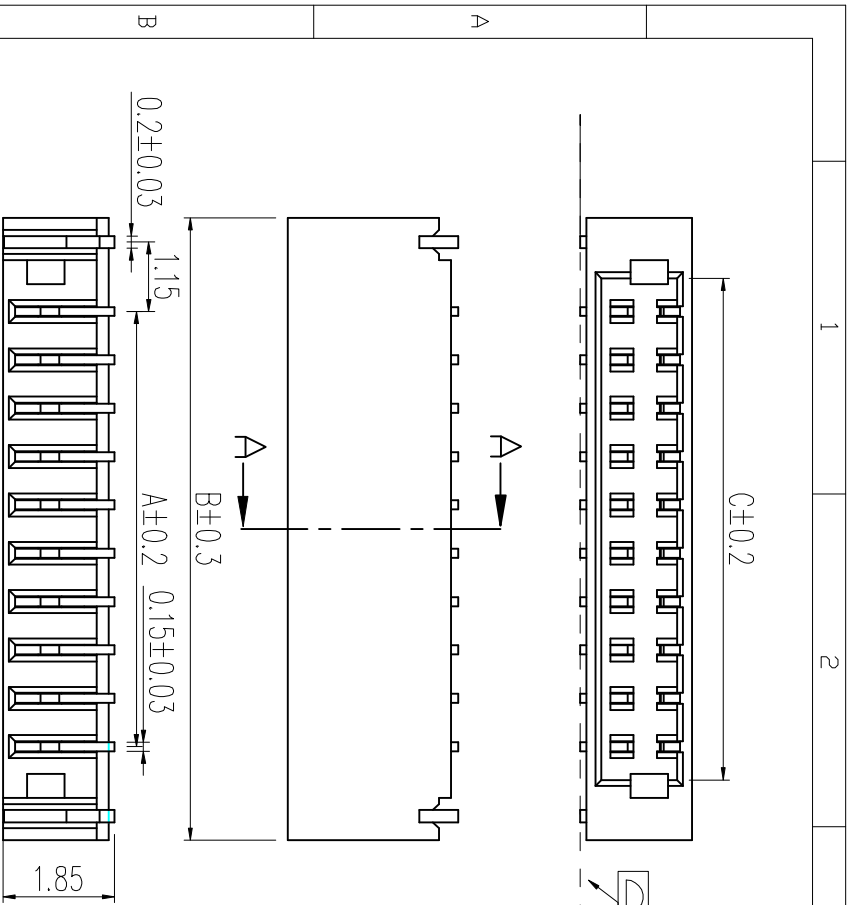

Circuits	Dimensions (mm)			Circuits	Dimensions (mm)		
	A	B	C		A	B	C
0.8WT-2P	0.8	3.90	1.90	0.8WT-12P	8.80	11.90	9.90
0.8WT-3P	1.6	4.70	2.70	0.8WT-13P	9.60	12.70	10.70
0.8WT-4P	2.4	5.50	3.50	0.8WT-14P	10.40	13.50	11.50
0.8WT-5P	3.2	6.30	4.30	0.8WT-15P	11.20	14.30	12.30
0.8WT-6P	4.0	7.10	5.10	0.8WT-16P	12.00	15.10	13.10
0.8WT-7P	4.8	7.90	5.90	0.8WT-17P	12.80	15.90	13.90
0.8WT-8P	5.6	8.70	6.70	0.8WT-18P	13.60	16.70	14.70
0.8WT-9P	6.4	9.50	7.50	0.8WT-19P	14.40	17.50	15.50
0.8WT-10P	7.2	10.30	8.30	0.8WT-20P	15.20	18.30	16.30
0.8WT-11P	8.0	11.10	9.10				

NO	物料名称	规格型号	数量 (PCS)	材质	镀涂	物料编码
①	底座	0.8	1	LCPEI30I	本色	
②	焊片	0.8	2	磷铜	锡	
③	插针	0.8	2~20	磷铜	锡	

RCN NO	标记	变更内容	签名	日期	未注公差	投影	重量	g	编制/日期	周少华 2019.09.12
					±0.30	☉			审核/日期	李永强 2019.09.12
					±0.20				批准/日期	田泽民 2019.09.12
					±0.10					
					±3.0°					

型号 AFC08-S\*\*QCA-00

1. 技术参数:  
 1.1 额定电流: 0.5A AC/DC  
 1.2 额定电压: 50V  
 1.3 额定电压: 500V AC/minute  
 1.4 接触电阻: 20mΩ MAX  
 1.5 绝缘电阻: 1000Ω MIN  
 2. 工作温度: -25℃~+85℃

更改记录	1	2	3	4	5

深圳市钜硕电子有限公司  
 SHENZHEN JUSHUO ELECTRONIC CO.,LTD

A4	1	2	3	4	5	6	7	8
						更正记录	修订人	审核

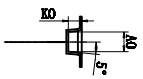
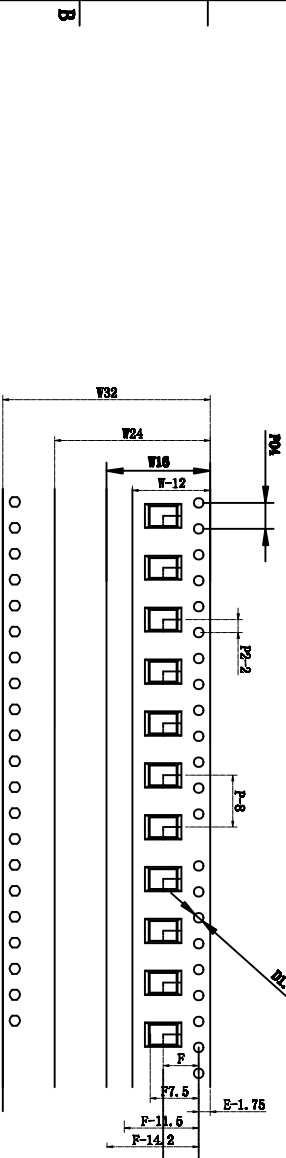

### 卷装示意图仅供参考

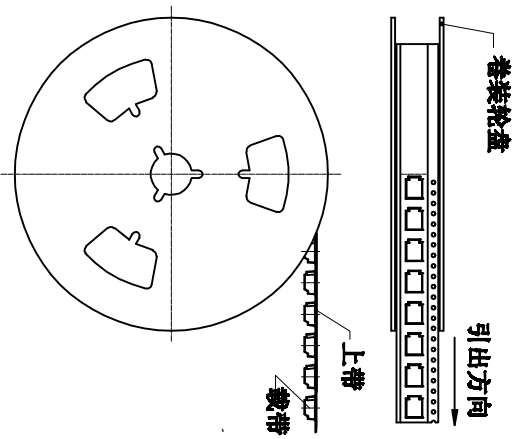

### 0.8mm贴片系列

	W	B0	F
2P	12.00±0.30	4.10±0.10	6.80±0.10
3P	12.00±0.30	4.90±0.10	6.80±0.10
4P	16.00±0.30	5.70±0.10	7.80±0.10
5P	16.00±0.30	6.50±0.10	7.80±0.10
6P	16.00±0.30	7.30±0.10	7.80±0.10
7P	16.00±0.30	8.10±0.10	7.80±0.10
8P	16.00±0.30	8.90±0.10	7.80±0.10
9P	24.00±0.30	9.70±0.10	11.6±0.10
10P	24.00±0.30	10.5±0.10	11.6±0.10

### 尺寸栏

E	1.75±0.10
F	5.50±0.10
P2	2.00±0.10
φD	1.50±0.10 0.00
P0	4.00±0.10
W	12.00±0.30
P	8.00±0.10
A0	3.05±0.10
B0	4.10±0.10
K0	2.10±0.10
t	0.30±0.05

生产参数	
模数	340 模
颗数	4080 颗
卷数	330mm
包装数	4000 颗

- 说明
- 10个边孔的累计公差不能超过±0.2mm.
  - 材料规格: PS 白色抗静电, 厚度 0.30mm.
  - 13英寸卷轮卷装长度: 32.64米, 包装零件总颗数: 4080颗, 每盘实包颗数: 4000颗
  - 所有尺寸设计参照 EIA-481-C-2003.
  - 载带在250mm长度内最大弯曲不能超过1mm 见上图

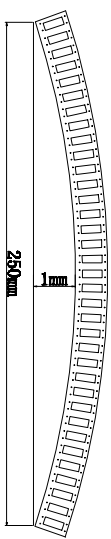

深圳市钜硕电子有限公司 SHENZHEN JUSHUO ELECTRONIC CO.,LTD	AFC08-S**QCA-00
审核	0.8mm卧式贴片

日期: 2020年1月10日	单位: mm
	比例: 1:1

## X-ON Electronics

Largest Supplier of Electrical and Electronic Components

*Click to view similar products for [FFC & FPC Connectors](#) category:*

*Click to view products by [JUSHUO](#) manufacturer:*

Other Similar products are found below :

[00-6200-227-022-800](#) [006205250500825+](#) [006205280500825+](#) [FPH-1602G](#) [FPH-2022G](#) [52610-1275](#) [501864-3091-TR225](#)  
[086222026001800](#) [52610-0675](#) [62674-201121DLF](#) [62684-36210E9ALF](#) [52746-1671-TR250](#) [10051922-2810EHLF](#) [686322124422](#) [XF3M-](#)  
[2915-1B-R100](#) [AYF353125A](#) [AYF530665TA](#) [AYF534065TA](#) [AYF351525](#) [086212040340800+](#) [AYF530365TA](#) [67000-004LF](#)  
[006207341915000+](#) [207356-1](#) [67000-003LF](#) [HFW14R-2STE9LF](#) [SFW12R-5STE9LF](#) [SFW18R-1STAE9LF](#) [SFW4R-5STE9LF](#) [52807-0430](#)  
[046283021002868+](#) [502250-8027](#) [104267-9617](#) [66987-011LF](#) [HFW8S-2STAE1HLF](#) [67000-008LF](#) [HFW22R-2STE1H1LF](#) [0781271110](#)  
[5019511030](#) [200528-0260](#) [5039084120](#) [503908-5120](#) [SFW20R-1STGE5LF](#) [FH12-18S-0.5SH](#) [686116183522](#) [FH64MA-11S-0.25SHW](#)  
[686114183522](#) [502078-5362](#) [FH52K-68S-0.5SH](#) [FH26W-23S-0.3SHW\(60\)](#)