

NOTES:

1. 10 SPROCKET HOLE PITCH CUMULATIVE TOLERANCE.±0.20mm
2. CARRIER CAMBER NOT TO EXCEED 1mm IN 250mm.
3. ALL DIMENSIONS MEET EIA-481-C REQUIREMENTS.
4. MATERIAL: BLACK ANTI-STATIC POLYSTYRENE.
5. THICKNESS: 0.30 ± 0.05 mm.
6. PACKING LENGTH PER 13" REEL : 36.60METERS.
7. COMPONENT LOAD PER 13" REEL : 3000PCS.
8. PEELING OFF FORCE OF TOP TAPE 0.1N~0.7N(10.2gf~71.4gf).

EB-450XXX125-XX

- 00: 黑色 (3000PCS/Reel)
- 01: 白色 (3000PCS/Reel)
- 03: 白色 (4000PCS/Reel)

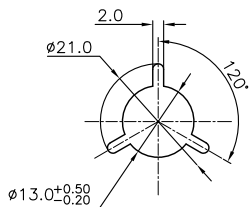
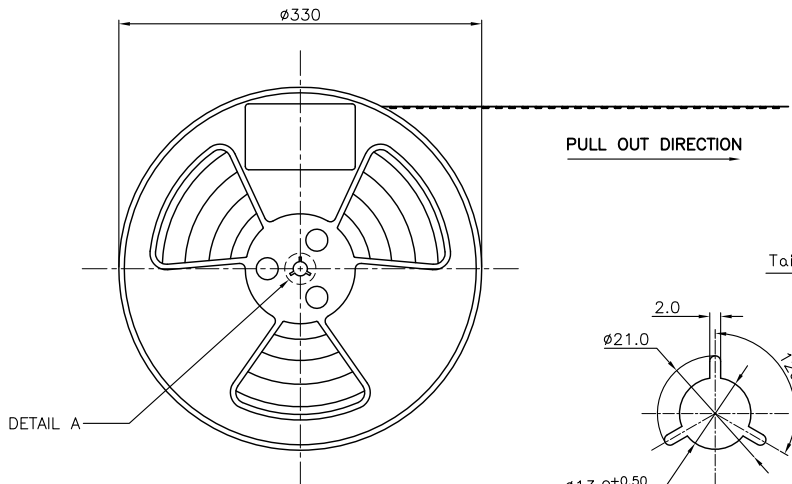
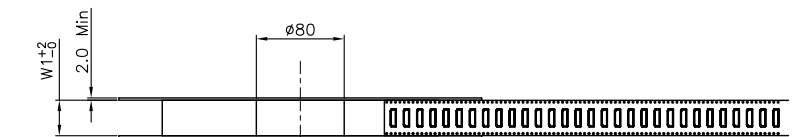

DETAIL A

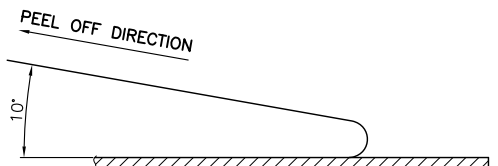
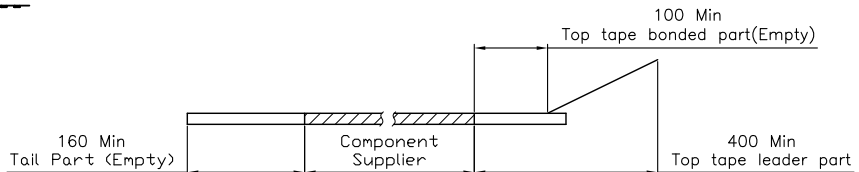

PULL OUT DIRECTION

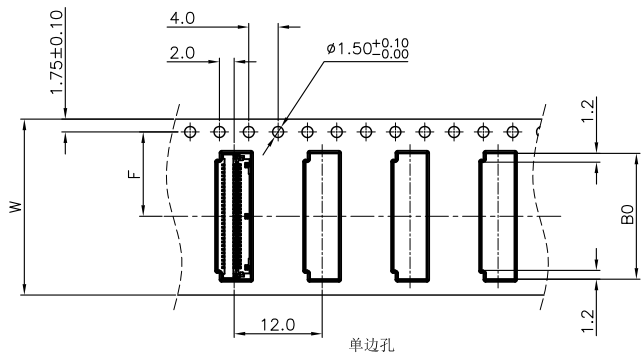
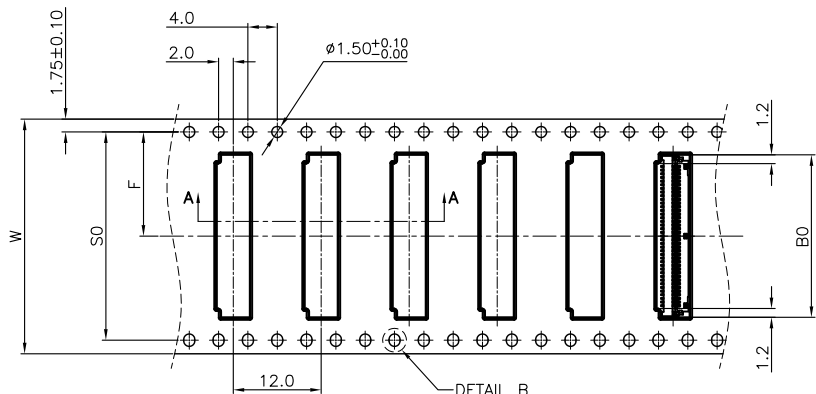

单边孔

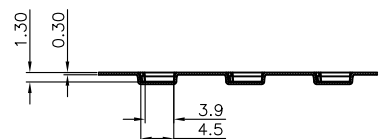

SECTION A-A
SCALE 1:1

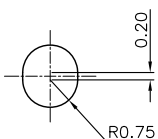

DETAIL B
SCALE 5:1

CKTS	B0±0.10	W	W1	F	SO±0.10
4	4.67				
5	5.17				
6	5.67				
7	6.17				
8	6.67	16+0.3/-0	16.4	7.5±0.10	
9	7.17				
10	7.67				
11	8.17				
12	8.67				
13	9.17				
14	9.67				
15	10.17				
16	10.67				
17	11.17				
18	11.67				
19	12.17				
20	12.67				
21	13.17	24+0.3/-0	24.4	11.5±0.10	
22	13.67				
23	14.17				
24	14.67				
25	15.17				
26	15.67				
27	16.17				
28	16.67				
29	17.17				
30	17.67				
31	18.17				
32	18.67				
33	19.17				
34	19.67	32±0.30	32.4	14.2±0.10	28.4
35	20.17				
36	20.67				
37	21.17				
38	21.67				
39	22.17				
40	22.67	44±0.30	44.4	20.2±0.15	40.4

单边孔

CLASSIFICATION DIMENSION (尺寸类别): FAT (首次检验): ⊗To ⊗ ■ MARK IS MAJOR DIM (重点尺寸标示) ⊙ MARK IS CRITICAL DIM (Cpk&Cp标示)	
Tolerance Unspecified (未注公差)	Size (图幅): A4
0.0 ±0.10 0° ±3°	Unit (单位): MM
0.00 ±0.05 0° 0° ±2°	Scale (比例): 1:1
0.000 ±0.02 0° 0° ±1°	Page (页数): 1 OF 1
Project View (投影视角): 第三角	Rev (版本): 1.0

深圳市钜硕电子有限公司
SHENZHEN JUSHUO ELECTRONIC CO., LTD

Product Name (产品名称): 0.5Pitch H=0.95 FPC 掀盖卧式SMT型.载带	
Product No (产品料号): AFC48-S**F***	
Drawing No (图面编号): DNE00096-1	Date (日期): 2015/03/09
Designer (设计): Allan	Checked (审核): Approved (核准):

1.0	初版发行	2015/03/09	Allan
Rev 版本	Change Description 变更内容	Date 日期	Revisor 制/修订人

X-ON Electronics

Largest Supplier of Electrical and Electronic Components

Click to view similar products for [FFC & FPC Connectors](#) category:

Click to view products by [JUSHUO](#) manufacturer:

Other Similar products are found below :

[00-6200-227-022-800](#) [006205250500825+](#) [006205280500825+](#) [FPH-1602G](#) [FPH-2022G](#) [52610-1275](#) [501864-3091-TR225](#)
[086222026001800](#) [52610-0675](#) [62674-201121DLF](#) [62684-36210E9ALF](#) [52746-1671-TR250](#) [10051922-2810EHLF](#) [686322124422](#) [XF3M-](#)
[2915-1B-R100](#) [AYF353125A](#) [AYF530665TA](#) [AYF534065TA](#) [AYF351525](#) [086212040340800+](#) [AYF530365TA](#) [67000-004LF](#)
[006207341915000+](#) [207356-1](#) [67000-003LF](#) [HFW14R-2STE9LF](#) [SFW12R-5STE9LF](#) [SFW18R-1STAE9LF](#) [SFW4R-5STE9LF](#) [52807-0430](#)
[046283021002868+](#) [502250-8027](#) [104267-9617](#) [66987-011LF](#) [HFW8S-2STAE1HLF](#) [67000-008LF](#) [HFW22R-2STE1H1LF](#) [0781271110](#)
[5019511030](#) [200528-0260](#) [5039084120](#) [503908-5120](#) [SFW20R-1STGE5LF](#) [FH12-18S-0.5SH](#) [686116183522](#) [FH64MA-11S-0.25SHW](#)
[686114183522](#) [502078-5362](#) [FH52K-68S-0.5SH](#) [FH26W-23S-0.3SHW\(60\)](#)