

- NOTES:
1. 10 SPROCKET HOLE PITCH CUMULATIVE TOLERANCE.±0.20mm
 2. CARRIER CAMBER NOT TO EXCEED 1mm IN 250mm.
 3. ALL DIMENSIONS MEET EIA-481-D REQUIREMENTS.
 4. MATERIAL: BLACK ANTI-STATIC POLYSTYRENE.
 5. THICKNESS: 0.30 ± 0.05 mm.
 6. PACKING LENGTH PER 13" REEL: 24.60METERS.
 7. COMPONENT LOAD PER 13" REEL: 2000PCS
 8. PEELING OFF FORCE OF TOP TAPE 0.1N~0.7N(10.2gf~71.4gf).

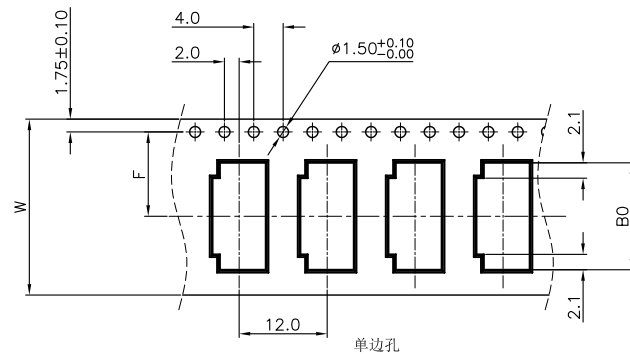

CKTS	B0±0.10	W	W1	F	S0±0.10
4	7.10				
5	7.60	16+0.3/-0	16.4	7.5±0.10	
6	8.10				
7	8.60				
8	9.10				
9	9.60				
10	10.10				
11	10.60				
12	11.10				
13	11.60	24+0.3/-0	24.4	11.5±0.10	单边孔
14	12.10				
15	12.60				
16	13.10				
17	13.60				
18	14.10				
19	14.60				
20	15.10				
21	15.60				
22	16.10				
23	16.60				
24	17.10				
25	17.60				
26	18.10	32±0.30	32.4	14.2±0.10	28.4
27	18.60				
28	19.10				
29	19.60				
30	20.10				
31	20.60				
32	21.10				
33	21.60				
34	22.10				
35	22.60				
36	23.10				
37	23.60				
38	24.10				
39	24.60	44±0.30	44.4	20.2±0.15	40.4
40	25.10				
41	25.60				
42	26.10				
43	26.60				
44	27.10				
45	27.60				
46	28.10				
47	28.60				
48	29.10				
49	29.60				
50	30.10				
51	30.60				
52	31.10				
53	31.60	56±0.30	56.4	26.2±0.15	52.4
54	32.10				
55	32.60				
56	33.10				
57	33.60				
58	34.10				
59	34.60				
60	35.10				

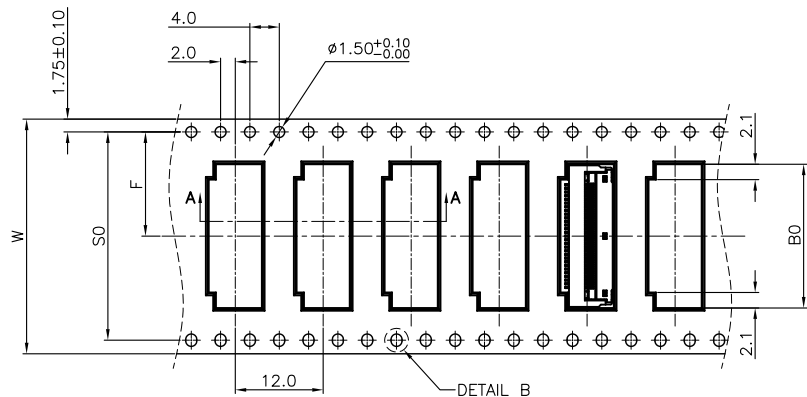
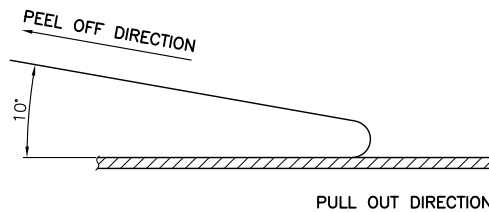
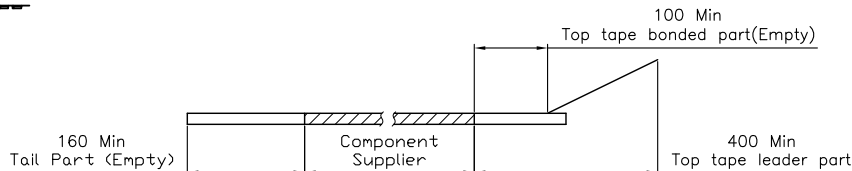
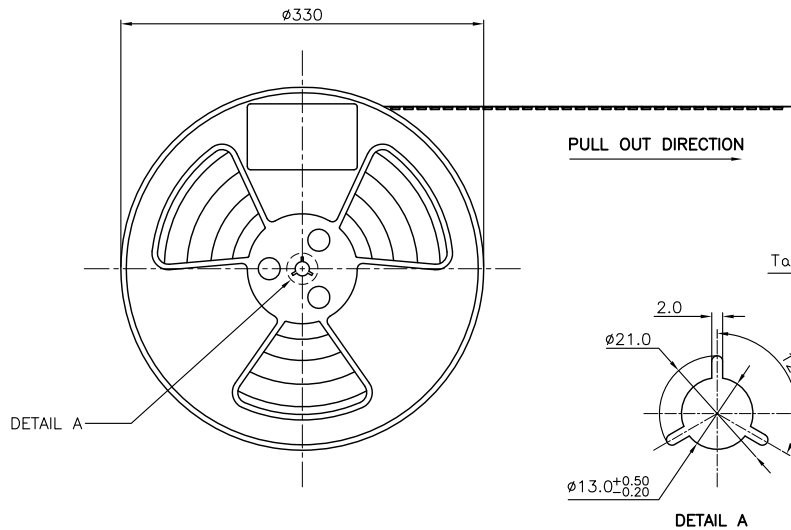
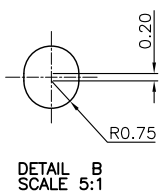
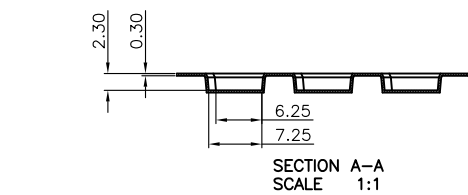

CLASSIFICATION DIMENSION (尺寸类别):
 FAT (首次检验): ☉To ☉
 ■ MARK IS MAJOR DIM (重点尺寸标示)
 * MARK IS CRITICAL DIM (Cpk&Cp标示)

Tolerance Unspecified (未注公差)	Size (图幅): A4
0.0 ±0.10 0°. ±3°	Unit (单位): MM
0.00 ±0.05 0°. ±2°	Scale (比例): 1:1
0.000 ±0.02 0°.00 ±1°	Page (页数): 1 OF 1
Project View (投影视角):	Rev (版本): 1.0

深圳市钜硕电子有限公司
 SHENZHEN JUSHUO ELECTRONIC CO., LTD

Product Name (产品名称):
 0.5Pitch H=2.0 FPC 掀盖卧式5代SMT载带

Product No (产品料号):
 AFC64-S**F***

Drawing No (图面编号): DNE00126-1
 Date (日期): 2017/04/10

Designer (设计): Allan
 Checked (审核):
 Approved (核准):

1.0	初版发行	2017/04/10	Allan
Rev 版本	Change Description 变更内容	Date 日期	Revisor 制/修订人

X-ON Electronics

Largest Supplier of Electrical and Electronic Components

Click to view similar products for [FFC & FPC Connectors](#) category:

Click to view products by [JUSHUO](#) manufacturer:

Other Similar products are found below :

[00-6200-227-022-800](#) [006205250500825+](#) [006205280500825+](#) [FPH-1602G](#) [FPH-2022G](#) [52610-1275](#) [501864-3091-TR225](#)
[086222026001800](#) [52610-0675](#) [62674-201121DLF](#) [62684-36210E9ALF](#) [52746-1671-TR250](#) [10051922-2810EHLF](#) [686322124422](#) [XF3M-](#)
[2915-1B-R100](#) [AYF353125A](#) [AYF530665TA](#) [AYF534065TA](#) [AYF351525](#) [086212040340800+](#) [AYF530365TA](#) [67000-004LF](#)
[006207341915000+](#) [207356-1](#) [67000-003LF](#) [HFW14R-2STE9LF](#) [SFW12R-5STE9LF](#) [SFW18R-1STAE9LF](#) [SFW4R-5STE9LF](#) [52807-0430](#)
[046283021002868+](#) [502250-8027](#) [104267-9617](#) [66987-011LF](#) [HFW8S-2STAE1HLF](#) [67000-008LF](#) [HFW22R-2STE1H1LF](#) [0781271110](#)
[5019511030](#) [200528-0260](#) [5039084120](#) [503908-5120](#) [SFW20R-1STGE5LF](#) [FH12-18S-0.5SH](#) [686116183522](#) [FH64MA-11S-0.25SHW](#)
[686114183522](#) [502078-5362](#) [FH52K-68S-0.5SH](#) [FH26W-23S-0.3SHW\(60\)](#)