

RECOMMENDED P.C.B PATTERN LAYOUT

RECOMMENDED FPC/FFC DIMENSION

Note:

- Material:
  - Housing: thermoplastic high temp.UL94V-0; Color: natural
  - Latch: thermoplastic high temp.UL94V-0; Color: black.
  - Terminal: copper alloy.
  - Fitting Nail: copper alloy.
- Finish:
  - Terminal: Underplating: Gold flash overall.
  - Fitting Nail: Underplating: matt Tin overall.
- Product must comply HF RoHS specification.

4. Product No:

AFE05-S \*\* F \* \* - \*\*  
 CKTS CONTACTS TYPE F: Lower  
 PLATING: 1:Gold flash 1u", 2:Gold flash 2u", 3:Gold flash 3u", 4:Gold flash 5u", K:Gold point 3u", L:Gold point 4u", M:Gold point 5u"  
 PACKING: A:Tape&Reel, C:Tube, E:Tape&Reel With Mylar, G:Tube With Mylar  
 REMARKS: HF:Halogen free, 1H:Housing :Black

CKTS	DIM A	DIM B	DIM C	DIM D	DIM E
11	3.00	2.40	4.39	3.63	4.90
13	3.60	3.00	4.99	4.23	5.50
15	4.20	3.60	5.59	4.83	6.10
17	4.80	4.20	6.19	5.43	6.70
19	5.40	4.80	6.79	6.03	7.30
21	6.00	5.40	7.39	6.63	7.90
23	6.60	6.00	7.99	7.23	8.50
25	7.20	6.60	8.59	7.83	9.10
27	7.80	7.20	9.19	8.43	9.70
29	8.40	7.80	9.79	9.03	10.30
31	9.00	8.40	10.39	9.63	10.90
33	9.60	9.00	10.99	10.23	11.50
35	10.20	9.60	11.59	10.83	12.10
37	10.80	10.20	12.19	11.43	12.70
39	11.40	10.80	12.79	12.03	13.30
41	12.00	11.40	13.39	12.63	13.90
43	12.60	12.00	13.99	13.23	14.50
45	13.20	12.60	14.59	13.83	15.10
47	13.80	13.20	15.19	14.43	15.70
49	14.40	13.80	15.79	15.03	16.30
51	15.00	14.40	16.39	15.63	16.90
53	15.60	15.00	16.99	16.23	17.50
55	16.20	15.60	17.59	16.83	18.10
57	16.80	16.20	18.19	17.43	18.70
59	17.40	16.80	18.79	18.03	19.30
61	18.00	17.40	19.39	18.63	19.90

CUSTOMER DRAWING	
Tolerance Unspecified (未注公差)	Size (图幅): A4
0.0 ±0.15 0° ±5°	Unit (单位): MM
0.00 ±0.10 0° ±3°	Scale (比例): 1:1
0.000 ±0.05 0° ±1°	Page (页数): 1 OF 1
Project View (投影视角)	Rev (版本): B

深圳市钜硕电子有限公司

Product Name (产品名称): 0.3Pitch H=1.0 FPC/FFC Easy-on R/A Type3 SMT CONN  
 Product No (产品料号): AFE05-S\*\*F\*\*\*-\*\*  
 Designer (设计): 吴小光  
 Checked (审核):  
 Approved (核准):

Rev	Change Description	Date	Revisor
B	增加进胶区分	2019/08/17	吴小光
A	Original Issue	2016/07/18	Allan
版本	变更内容	日期	制/修订人

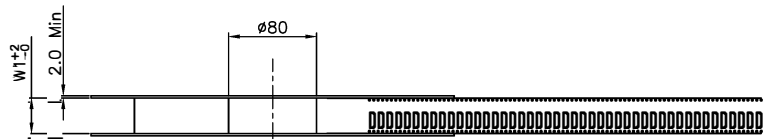

**NOTES:**

1. 10 SPROCKET HOLE PITCH CUMULATIVE TOLERANCE.±0.20mm
2. CARRIER CAMBER NOT TO EXCEED 1mm IN 250mm.
3. ALL DIMENSIONS MEET EIA-481-C REQUIREMENTS.
4. MATERIAL: BLACK ANTI-STATIC POLYSTYRENE.
5. THICKNESS: 0.30 ± 0.05 mm.
6. PACKING LENGTH PER 13" REEL : 40.40METERS.
7. COMPONENT LOAD PER 13" REEL : 5000PCS.
8. PEELING OFF FORCE OF TOP TAPE 0.1N~0.7N(10.2gf~71.4gf).

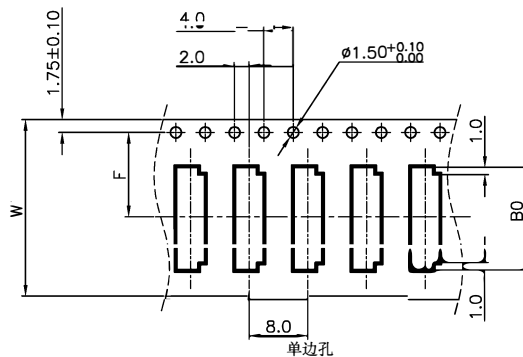
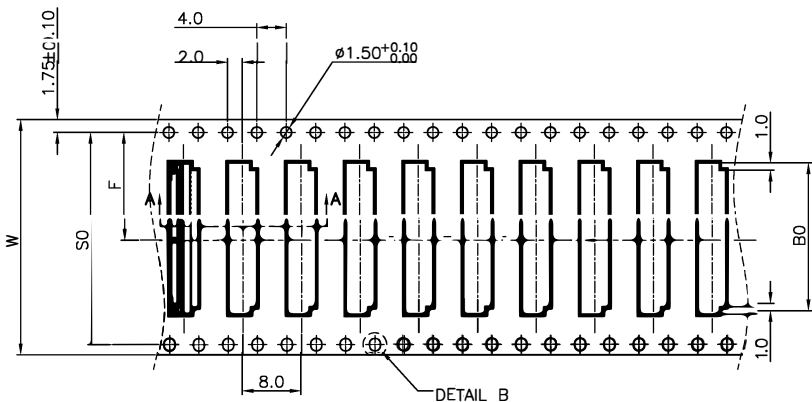
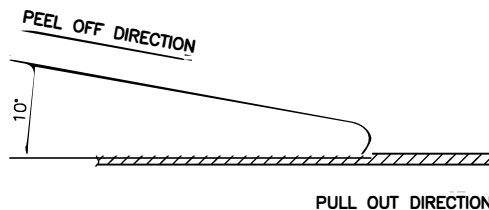
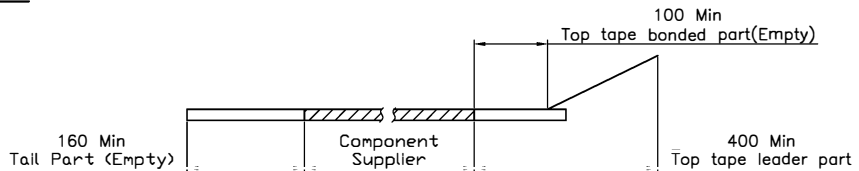
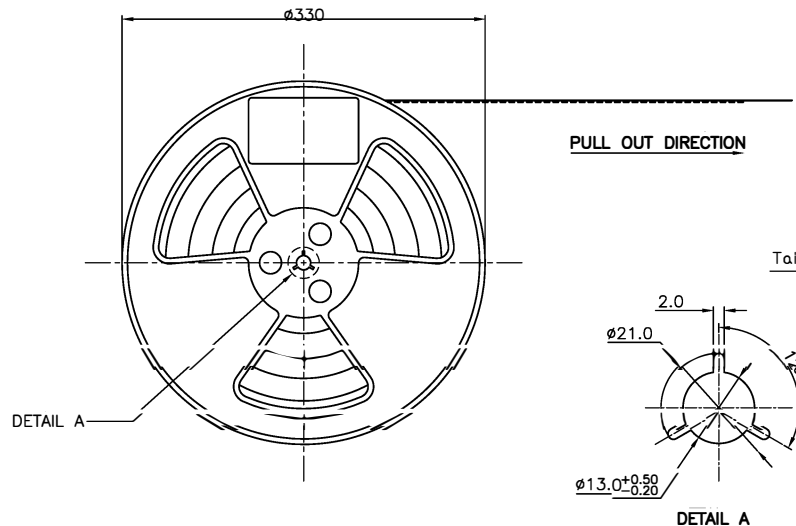

CKTS	B0±0.10	W	W1	F±0.10	S0±0.10
11	5.10				
13	5.70				
15	6.30				
17	6.90	16±0.3/-0	16.4	7.5	
19	7.50				
21	8.10				
23	8.70				
25	9.30				
27	9.90				
29	10.50				
31	11.10				
33	11.70				
35	12.30				
37	12.90	24±0.3/-0	24.4	11.5	
39	13.50				
41	14.10				
43	14.70				
45	15.30				
47	15.90				
49	16.50				
51	17.10				
53	17.70				
55	18.30				
57	18.90	32±0.30	32.4	14.2	28.4
59	19.50				
61	20.10				

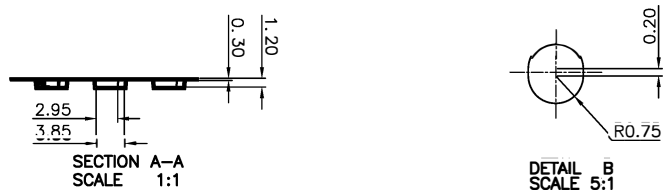

CLASSIFICATION DIMENSION (尺寸类别):  
 FAI (首次检验): ⊕To⊕  
 ■ MARK IS MAJOR DIM (重点尺寸标示)  
 ⊕ MARK IS CRITICAL DIM (Cpk&Cp标示)

Tolerance Unspecified (未注公差)  
 0.0 ±0.10 0° ±3°  
 0.00 ±0.05 0° 0 ±2°  
 0.000 ±0.02 0° 0.00 ±1°

Size (图幅): A4  
 Unit (单位): MM  
 Scale (比例): 1:1  
 Page (页数): 1 OF 1  
 Rev (版本): 1.0

Project View (投影视图):

**深圳市钜硕电子有限公司**

Product Name (产品名称): 0.3Pitch H=1.0 FPC/FPC 掀盖卧式3代SMT型. 载带 (反向)

Product No (产品料号): AFE05-S\*\*E\*\*\*

Drawing No (图面编号): DNE00102-1 Date (日期): 2018/09/06

Designer (设计): 张孝雄 Checked (审核): Approved (核准):

Rev 版本	Change Description 变更内容	Date 日期	Revisor 制/修订人
1.0	初版发行新增反向规格	2018/09/06	张孝雄

## X-ON Electronics

Largest Supplier of Electrical and Electronic Components

*Click to view similar products for [FFC & FPC Connectors](#) category:*

*Click to view products by [JUSHUO](#) manufacturer:*

Other Similar products are found below :

[00-6200-227-022-800](#) [006205250500825+](#) [006205280500825+](#) [FPH-1602G](#) [086222026001800](#) [52610-0675](#) [62674-201121DLF](#) [52746-1671-TR250](#) [10051922-1610EHLF](#) [10051922-2810EHLF](#) [686322124422](#) [XF3M-2915-1B-R100](#) [AYF353125A](#) [AYF530665TA](#) [AYF534065TA](#) [20FLH-RSM1-TB](#) [PCA-7F-25-HL-3-G](#) [207356-1](#) [52807-0430](#) [502250-8027](#) [FH28K-40S-0.5SH](#) [200528-0260](#) [FH28K-10S-0.5SH](#) [501951-1250](#) [X05B20U43T](#) [0.5K-DX-30PWB](#) [DS1020-08-10VBT12](#) [THD0515-34CL-GF](#) [X05A10L28G](#) [ECC2841061EU](#) [20539-030E-01](#) [1.0K-DHGX-16PWB](#) [1.0K-DHGX-30PWB](#) [1775333-6](#) [10054365-202110ELF](#) [10054365-242110ELF](#) [10054365-282110ELF](#) [10064555-392220HLF](#) [59453-041110EBHLF](#) [59453-091110EDHLF](#) [62674-241141ALF](#) [62684-432100ALF](#) [62684-451100AHLF](#) [62684-5721N0ALF](#) [HFW11R-1STE1MTLF](#) [HFW12R-1STE9LF](#) [HFW14R-1STE9MTLF](#) [HFW18S-2STE9LF](#) [HFW20R-1STAE1HLF](#) [HFW20R-1STE1MTLF](#)