



DFR1A THRU DFR1M

Surface Mount Fast Recovery Rectifiers

Reverse Voltage - 50 to 1000 V

Forward Current - 1 A

FEATURES

- For surface mounted applications
- Low profile package
- Glass Passivated Chip Junction
- Ideal for automated placement
- Fast reverse recovery time
- Lead free in comply with EU RoHS 2011/65/EU directives

MECHANICAL DATA

- Case: SOD-123FL
- Terminals: Solderable per MIL-STD-750, Method 2026
- Approx. Weight: 15mg 0 00048oz

PINNING

PIN	DESCRIPTION
1	Cathode
2	Anode

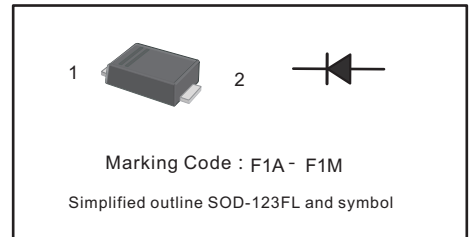

Maximum Ratings and Electrical characteristics

Ratings at 25 °C ambient temperature unless otherwise specified.

Single phase half-wave 60 Hz, resistive or inductive load, for capacitive load current derate by 20 %.

Parameter	Symbols	DFR1A	DFR1B	DFR1D	DFR1G	DFR1J	DFR1K	DFR1M	Units
Maximum Repetitive Peak Reverse Voltage	V_{RRM}	50	100	200	400	600	800	1000	V
Maximum RMS voltage	V_{RMS}	35	70	140	280	420	560	700	V
Maximum DC Blocking Voltage	V_{DC}	50	100	200	400	600	800	1000	V
Maximum Average Forward Rectified Current at $T_a = 65\text{ }^\circ\text{C}$	$I_{F(AV)}$	1							A
Peak Forward Surge Current 8.3 ms Single Half Sine Wave Superimposed on Rated Load (JEDEC Method)	I_{FSM}	30							A
Maximum Instantaneous Forward Voltage at 1 A	V_F	1.3							V
Maximum DC Reverse Current at Rated DC Blocking Voltage $T_a = 25\text{ }^\circ\text{C}$ $T_a = 125\text{ }^\circ\text{C}$	I_R	5 100							μA
Maximum Reverse Recovery Time ¹⁾	t_{rr}	150				250	500	ns	
Typical Junction Capacitance ²⁾	C_j	15							pF
Typical Thermal Resistance ³⁾	$R_{\theta JA}$	85							$^\circ\text{C/W}$
Operating and Storage Temperature Range	T_j, T_{stg}	-55 ~ +150							$^\circ\text{C}$

1) Measured with $I_F = 0.5\text{ A}$, $I_R = 1\text{ A}$, $I_{rr} = 0.25\text{ A}$

2) Measured at 1MHz and applied reverse voltage of 4V D.C

3) P.C.B. mounted with 2.0" X 2.0" (5 X 5 cm) copper pad areas.



DFR1A THRU DFR1M

Surface Mount Fast Recovery Rectifiers

Characteristic Curves ($T_A=25^\circ\text{C}$ unless otherwise noted)

Fig.1 Forward Current Derating Curve

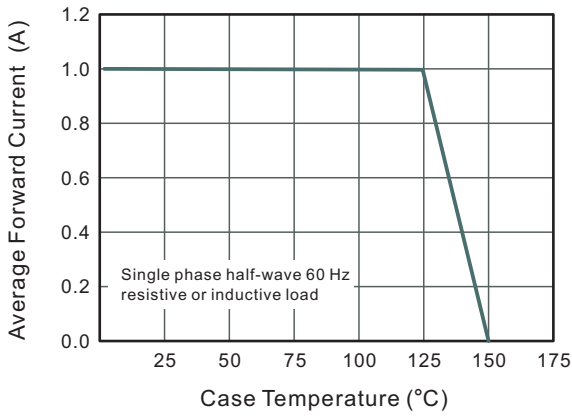

Fig.2 Typical Reverse Characteristics

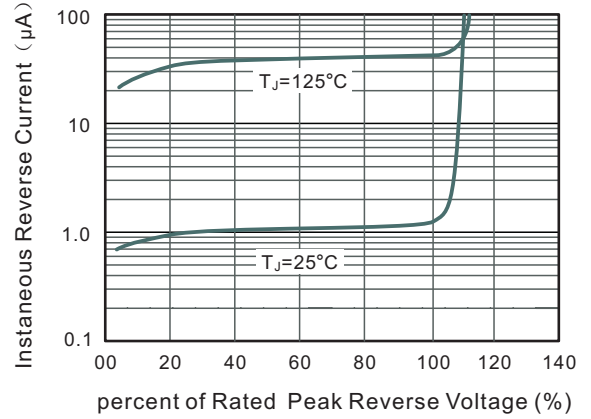

Fig.3 Typical Instantaneous Forward Characteristics

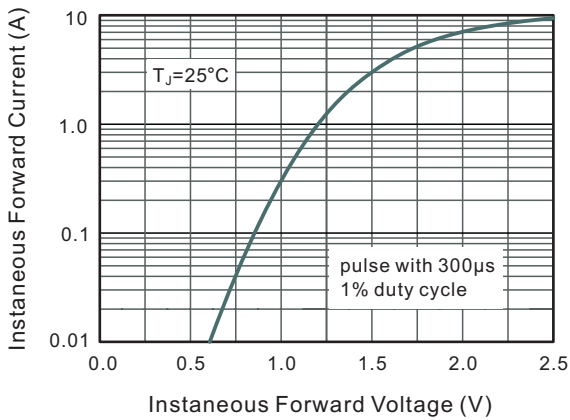

Fig.4 Typical Junction Capacitance

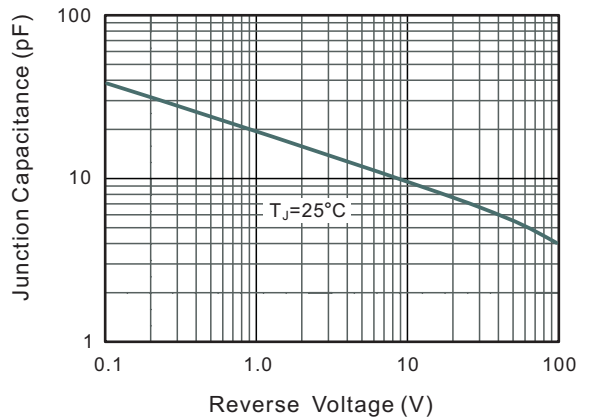
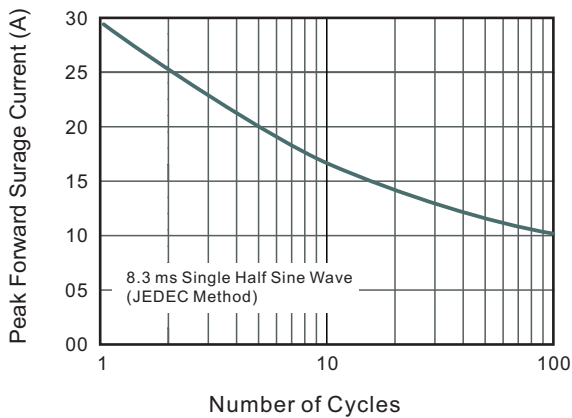

Fig.5 Maximum Non-Repetitive Peak Forward Surge Current





DFR1A THRU DFR1M

Surface Mount Fast Recovery Rectifiers

PACKAGE OUTLINE

Plastic surface mounted package; 2 leads

SOD-123FL

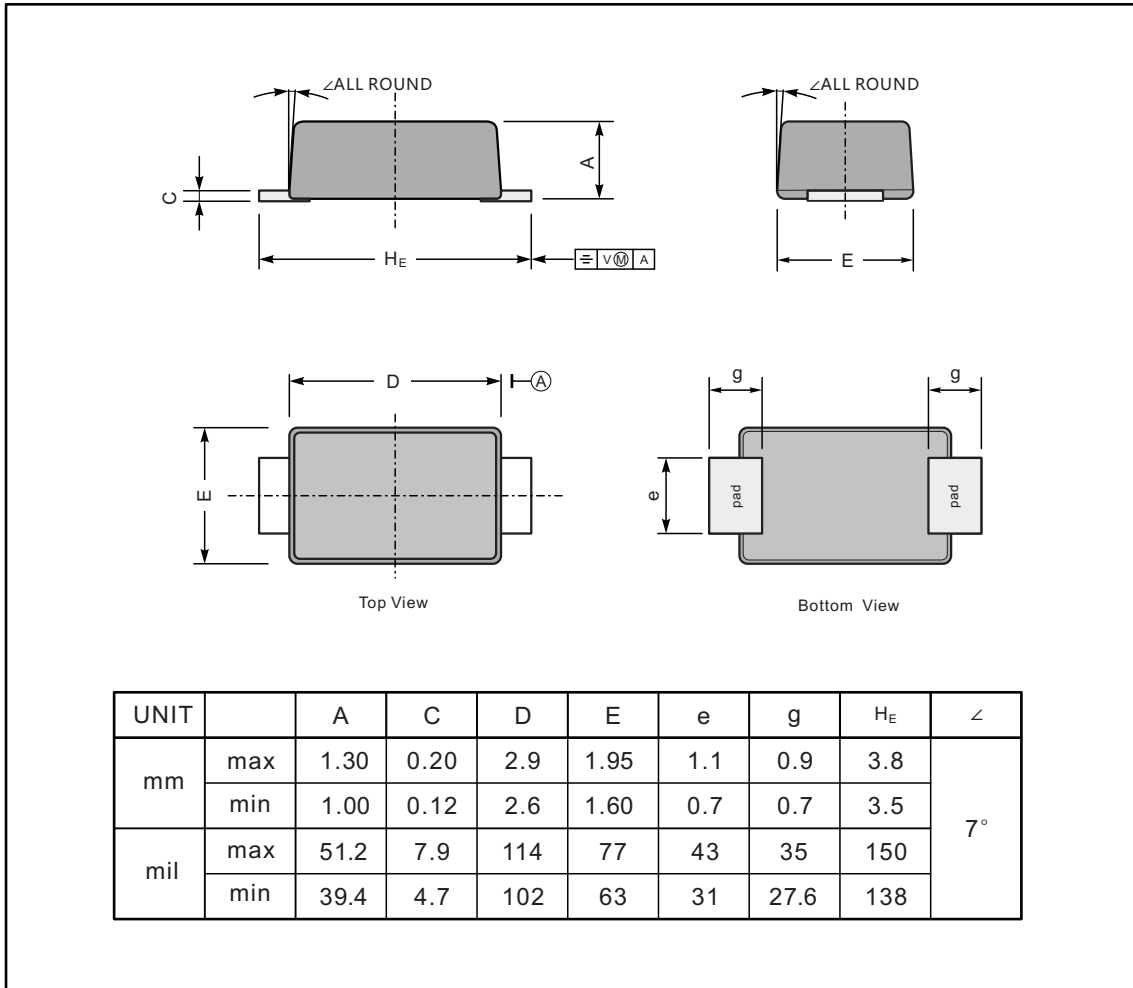

The recommended mounting pad size

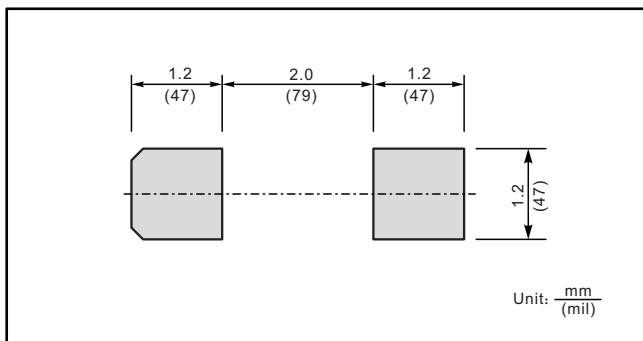

Marking

Type number	Marking code
DFR1A	F1A
DFR1B	F1B
DFR1D	F1D
DFR1G	F1G
DFR1J	F1J
DFR1K	F1K
DFR1M	F1M

X-ON Electronics

Largest Supplier of Electrical and Electronic Components

Click to view similar products for [Rectifiers](#) category:

Click to view products by [Juxing Electronic Technology](#) manufacturer:

Other Similar products are found below :

[70HFR40](#) [FR105 R0](#) [RL252-TP](#) [1N5397](#) [JANTX1N5634A](#) [1N4002G](#) [1N4005-TR](#) [JANS1N6640US](#) [481235F](#) [RRE02VS6SGTR](#) [067907F](#)
[MS306](#) [US2JFL-TP](#) [A1N5404G-G](#) [CRS12\(T5L,TEMQ\)](#) [ACGRB207-HF](#) [CLH07\(TE16L,Q\)](#) [CLH03\(TE16L,Q\)](#) [ACGRC307-HF](#)
[ACEFC304-HF](#) [DZ-1380](#) [NTE6356](#) [NTE6359](#) [JAN1N5555](#) [85HFR60](#) [40HFR60](#) [70HF120](#) [85HFR80](#) [D126A45C](#) [SCF7500](#) [SCHJ22.5K](#)
[SM100](#) [SCPA2](#) [SDHD5K](#) [ACGRA4001-HF](#) [D1821SH45T PR](#) [D1251S45T](#) [NTE6358](#) [NTE5850](#) [NTE5819](#) [NTE5837](#) [NTE5892](#) [NTE5900](#)
[NTE5911](#) [NTE5915](#) [NTE5921](#) [NTE6104](#) [NTE6105](#) [NTE6154](#) [NTE6158](#)