



FR301 THRU FR307

Fast Recovery Rectifiers

FEATURES

- High surge current capability
- Void-free Plastic in a DO-201AD package.
- 3.0 ampere operation at $T_A=55$ with no thermal runaway.
- Fast switching for high efficiency
- Exceeds environmental standards of MIL-S-19500/228
- Low leakage.

MECHANICAL DATA

Case: Molded plastic, DO-201AD
 Epoxy: UL 94V-O rate flame retardant
 Lead: Axial leads, solderable per MIL-STD-202, method 208 guaranteed
 Polarity: Color band denotes cathode end
 Mounting position: Any
 Weight: 0.04ounce, 1.1gram

DO-201AD(DO-27)

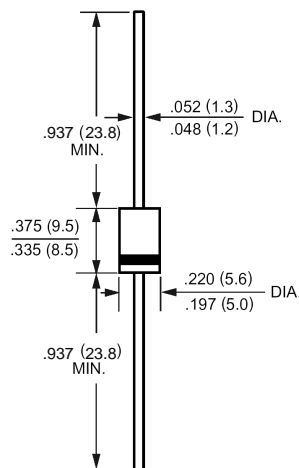

Dimensions in inches and (millimeters)

Maximum Ratings and Electrical Characteristics

Ratings at 25 ambient temperature unless otherwise specified.
 Single phase, half wave, 60Hz, resistive or inductive load.
 For capacitive load, derate current by 20%.

	Symbols	FR301	FR302	FR303	FR304	FR305	FR306	FR307	Units
Maximum Recurrent Peak Reverse Voltage	V_{RRM}	50	100	200	400	600	800	1000	Volts
Maximum RMS Voltage	V_{RMS}	35	70	140	280	420	560	700	Volts
Maximum DC Blocking Voltage	V_{DC}	50	100	200	400	600	800	1000	Volts
Maximum Average Forward Rectified Current .375"(9.5mm) Lead Length at $T_A=55$	$I_{(AV)}$	3.0							Amp
Peak Forward Surge Current, 8.3ms single half-sine-wave superimposed on rated load (JEDEC method)	I_{FSM}	125							Amp
Maximum Forward Voltage at 3.0A DC and 25	V_F	1.3							Volts
Maximum Reverse Current at $T_A=25$ at Rated DC Blocking Voltage $T_A=100$	I_R	5.0 500							μ Amp
Typical Junction Capacitance (Note 1)	C_J	60							pF
Typical Thermal Resistance (Note 2)	$R_{\theta JA}$	22							/W
Maximum Reverse Recovery Time (Note 3)	T_{RR}	150			250		500		nS
Operating and Storage Temperature Range	T_J, T_{stg}	-55 to +125							

NOTES:

- 1- Measured at 1 MHz and applied reverse voltage of 4.0 VDC.
- 2- Thermal Resistance From Junction to Ambient 0.375"(9.5mm) lead length P.C.B. Mounted with 0.8x0.8" (20x20mm) copper pads
- 3- Reverse Recovery Test Conditions : $I_F=.5A$, $I_R=1A$, $I_{RR}=.25A$.



FR301 THRU FR307

Fast Recovery Rectifiers

RATINGS AND CHARACTERISTIC CURVES

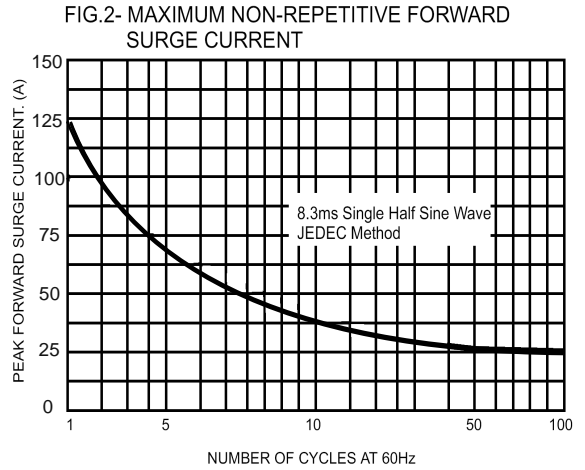
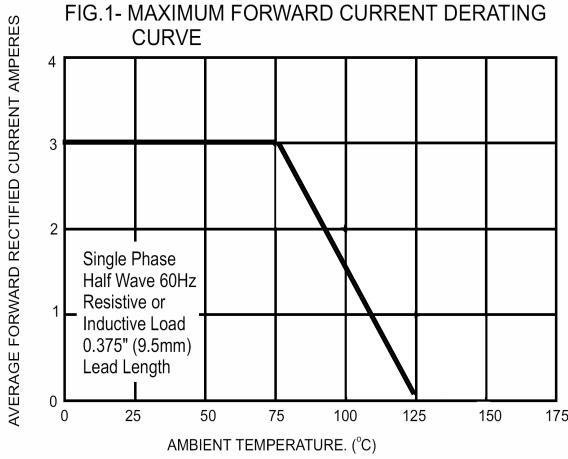

FIG.3- TYPICAL FORWARD CHARACTERISTICS

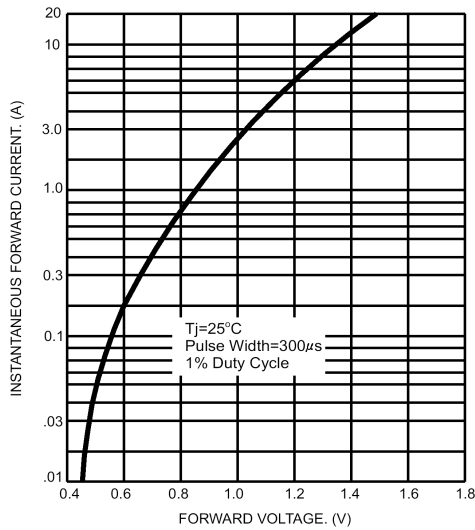

FIG.4- TYPICAL JUNCTION CAPACITANCE

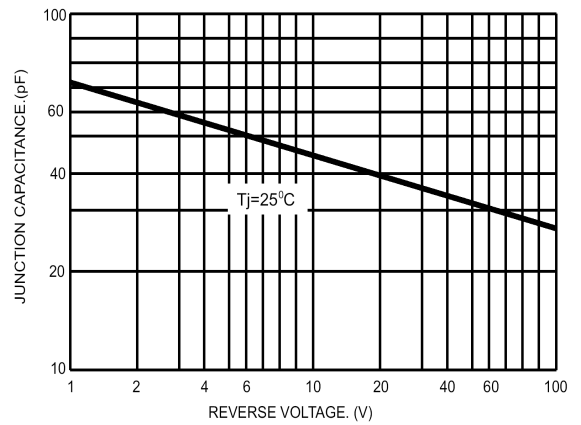
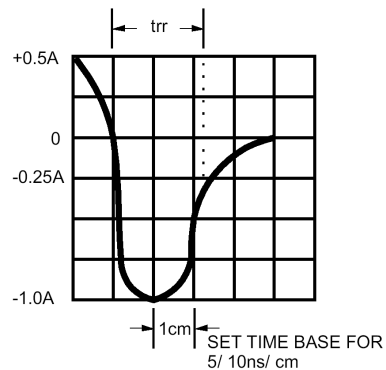
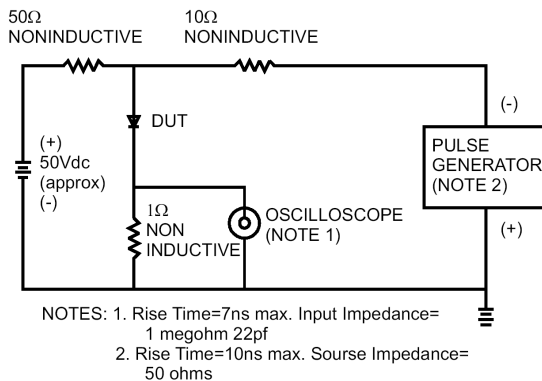

FIG.5- REVERSE RECOVERY TIME CHARACTERISTIC AND TEST CIRCUIT DIAGRAM



X-ON Electronics

Largest Supplier of Electrical and Electronic Components

Click to view similar products for [Rectifiers](#) category:

Click to view products by [Juxing Electronic Technology](#) manufacturer:

Other Similar products are found below :

[70HFR40](#) [FR105 R0](#) [RL252-TP](#) [1N5397](#) [1N4005-TR](#) [1N4007-BP](#) [UFS120Je3/TR13](#) [20ETS12S](#) [RRE02VS6SGTR](#) [MS306](#) [A1N5404G-G](#)
[CRF02\(T5L,TEMQ\)](#) [ACGRB207-HF](#) [CLH07\(TE16L,Q\)](#) [CLH03\(TE16L,Q\)](#) [1N5395-TP](#) [UES1302](#) [ACGRC307-HF](#) [ACEFC304-HF](#) [DZ-](#)
[1380](#) [85HFR60](#) [40HFR60](#) [70HF120](#) [85HFR80](#) [SCF7500](#) [SM100](#) [ACGRA4001-HF](#) [SKN70/08](#) [NTE5819](#) [NTE5827](#) [NTE5828](#) [NTE5911](#)
[NTE5915](#) [NTE6104](#) [NTE6163](#) [NTE6164](#) [NTE6165](#) [NTE6364](#) [TSD3G](#) [SET130312](#) [NRVUS110VT3G](#) [UES1106](#) [UES1306](#)
[NRVUS240VT3G](#) [D5FE60-5063](#) [R4000GPS-TP](#) [D4015L56TP](#) [UES1306HR2](#) [FX20K120](#) [D20XB60-7101](#)