



HER301G THRU HER308G

Ultra Fast Rectifiers

FEATURES

- Glass Passivated chip junction
- Plastic package has Underwriters Laboratory Flammability Classification 94V-O utilizing Flame Retardant Epoxy Molding Compound.
- Void-free Plastic in a DO-201AD package.
- 3.0 ampere operation at $T_A=55$ With no thermal runaway.
- Ultra Fast switching for high efficiency.
- Exceeds environmental standards of MIL-S-19500/228

MECHANICAL DATA

Case: Molded plastic, DO-201AD

Terminals: Axial leads, solderable per MIL-STD-202, method 208 guaranteed

Polarity: Band denotes cathode

Mounting position: Any

Weight: 0.04ounce, 1.1gram

DO-201AD(DO-27)

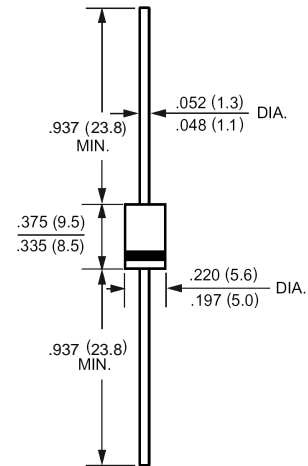

Dimensions in inches and (millimeters)

Maximum Ratings and Electrical Characteristics

Ratings at 25 ambient temperature unless otherwise specified.

Single phase, half wave, 60Hz, resistive or inductive load.

For capacitive load, derate current by 20%.

	Symbols	HER301G	HER302G	HER303G	HER304G	HER305G	HER306G	HER307G	HER308G	Units
Maximum Recurrent Peak Reverse Voltage	V_{RRM}	50	100	200	300	400	600	800	1000	Volts
Maximum RMS Voltage	V_{RMS}	35	70	140	210	280	420	560	700	Volts
Maximum DC Blocking Voltage	V_{DC}	50	100	200	300	400	600	800	1000	Volts
Maximum Average Forward Rectified Current .375"(9.5mm) Lead Length at $T_A=55$	$I_{(AV)}$	3.0								Amp
Peak Forward Surge Current, 8.3ms single half-sine-wave superimposed on rated load (JEDEC method)	I_{FSM}	125								Amp
Maximum Forward Voltage at 3.0A and $T_A=25$	V_F	1.0		1.3		1.7			Volts	
Maximum Reverse Current at $T_J=25$ at Rated DC Blocking Voltage $T_J=100$	I_R	10.0 750								uAmp
Typical Junction Capacitance (Note 1)	C_J	70					50			pF
Maximum Reverse Recovery Time (Note 2)	T_{RR}	50					75			nS
Typical Thermal Resistance (Note 3)	$R_{\theta JA}$	20								/W
Operating and Storage Temperature Range	T_J, T_{stg}	-55 to +150								

NOTES:

1- Measured at 1 MHz and applied reverse voltage of 4.0 VDC.

2- Reverse Recovery Test Conditions : $I_F=.5A$, $I_R=1A$, $I_{RR}=.25A$.

3- Thermal Resistance from Junction to Ambient at 0.375"(9.5mm) lead length P.C.B. Mounted.



HER301G THRU HER308G

Ultra Fast Rectifiers

RATINGS AND CHARACTERISTIC CURVES

FIG. 1 - TEST CIRCUIT DIAGRAM AND REVERSE RECOVERY TIME CHARACTERISTIC

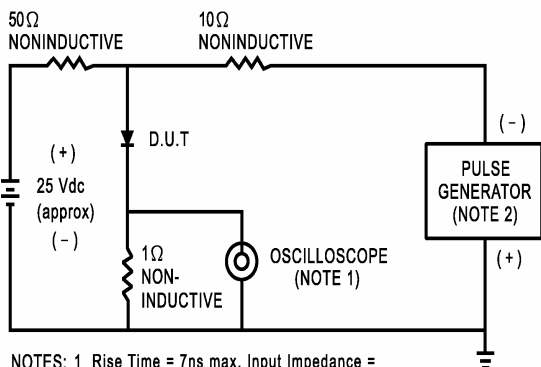

NOTES: 1. Rise Time = 7ns max. Input Impedance = 1 megohm. 22pF.
2. Rise Time = 10ns max. Source Impedance = 50 ohms.

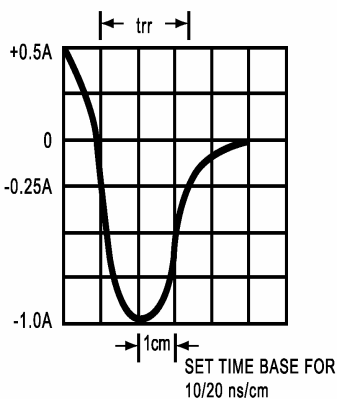

FIG. 2 - TYPICAL FORWARD CURRENT DERATING CURVE

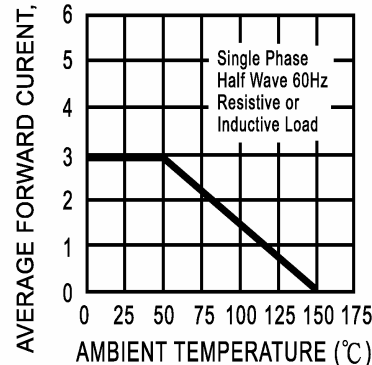

FIG. 3 - TYPICAL REVERSE CHARACTERISTICS

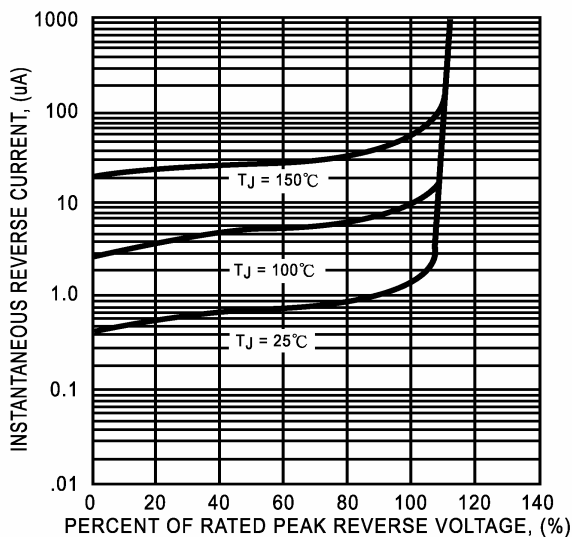

FIG. 4 - TYPICAL INSTANTANEOUS FORWARD CHARACTERISTICS

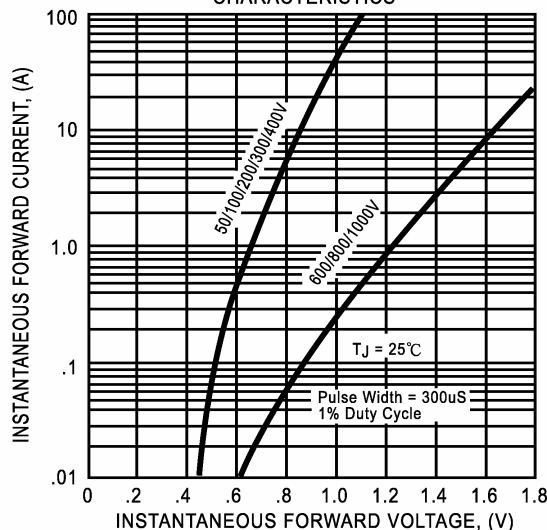

FIG. 5 - MAXIMUM NON-REPETITIVE FORWARD SURGE CURRENT

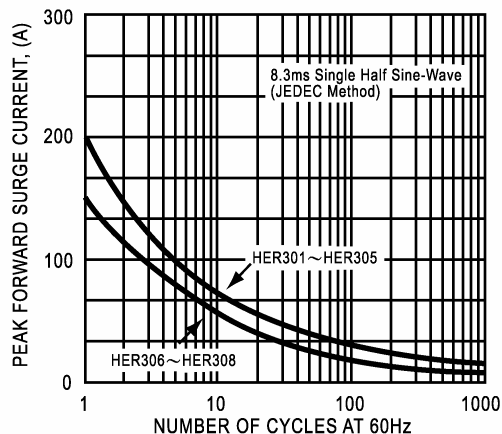
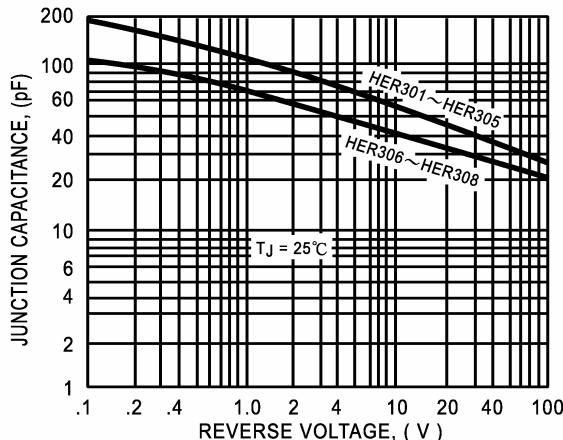

FIG. 6 - TYPICAL JUNCTION CAPACITANCE



X-ON Electronics

Largest Supplier of Electrical and Electronic Components

Click to view similar products for [Rectifiers](#) category:

Click to view products by [Juxing Electronic Technology](#) manufacturer:

Other Similar products are found below :

[70HFR40](#) [FR105 R0](#) [RL252-TP](#) [1N5397](#) [1N4005-TR](#) [1N4007-BP](#) [UFS120Je3/TR13](#) [20ETS12S](#) [RRE02VS6SGTR](#) [MS306](#) [A1N5404G-G](#)
[CRF02\(T5L,TEMQ\)](#) [ACGRB207-HF](#) [CLH07\(TE16L,Q\)](#) [CLH03\(TE16L,Q\)](#) [1N5395-TP](#) [UES1302](#) [ACGRC307-HF](#) [ACEFC304-HF](#) [DZ-](#)
[1380](#) [85HFR60](#) [40HFR60](#) [70HF120](#) [85HFR80](#) [SCF7500](#) [SM100](#) [ACGRA4001-HF](#) [SKN70/08](#) [NTE5819](#) [NTE5827](#) [NTE5828](#) [NTE5911](#)
[NTE5915](#) [NTE6104](#) [NTE6163](#) [NTE6164](#) [NTE6165](#) [NTE6364](#) [TSD3G](#) [SET130312](#) [NRVUS110VT3G](#) [UES1106](#) [UES1306](#)
[NRVUS240VT3G](#) [D5FE60-5063](#) [R4000GPS-TP](#) [D4015L56TP](#) [UES1306HR2](#) [FX20K120](#) [D20XB60-7101](#)