



M1~M7

Surface Mount Standard Rectifiers

FEATURES

- For surface mounted applications
- Low profile package
- Built-in strain relief
- Easy pick and place
- Low forward voltage drop
- Plastic package has Underwriters Laboratory Flammability Classification 94V-0
- High temperature soldering : 260°C /10 seconds at terminals

DO-214AC (SMA)

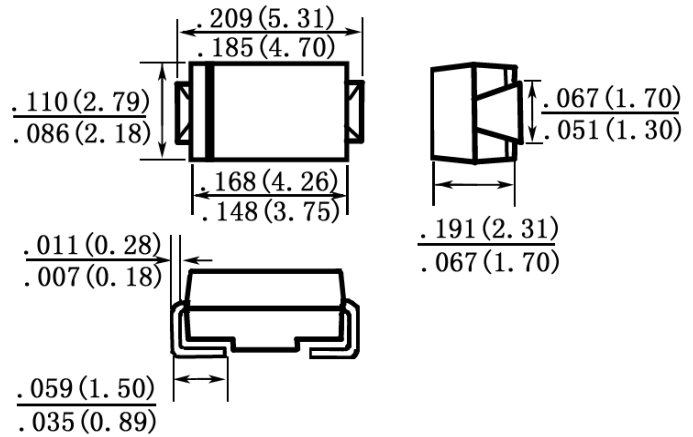

Dimensions in inches and (millimeters)

MECHANICAL DATA

Case: Molded plastic, SMX

Terminals: Solder plated, solderable per MIL-STD-750, method 2026 guaranteed

Polarity: Color band denotes cathode end

Packaging: 12mm tape per EIA STD RS-481

Weight: 0.002 ounce, 0.064 gram

Maximum Ratings and Electrical Characteristics

Ratings at 25 °C ambient temperature unless otherwise specified.

Single phase, half wave, 60Hz, resistive or inductive load.

For capacitive load, derate current by 20%.

	Symbols	M1	M2	M3	M4	M5	M6	M7	Units
Maximum Recurrent Peak Reverse Voltage	V_{RRM}	50	100	200	400	600	800	1000	Volts
Maximum RMS Voltage	V_{RMS}	35	70	140	280	420	560	700	Volts
Maximum DC Blocking Voltage	V_{DC}	50	100	200	400	600	800	1000	Volts
Maximum Average Forward Rectified Current at $T_L=75$	$I_{(AV)}$	1.0							Amp
Peak Forward Surge Current, 8.3ms single half-sine-wave superimposed on rated load (JEDEC method)	I_{FSM}	30							Amp
Maximum Forward Voltage at 1.0A	V_F	1.1							Volts
Maximum Reverse Current at $T_A=25$	I_R	5.0							μ Amp
at Rated DC Blocking Voltage $T_A=125$		100							
Typical Junction Capacitance (Note 1)	C_J	12							pF
Typical Thermal Resistance (Note 2)	$R_{\theta JA}$	28							/W
Maximum Reverse Recovery Time (Note 3)	T_{RR}	2.5							μ S
Operating Junction Temperature Range	T_J	-55 to +150							
Storage Temperature Range	T_{stg}	-55 to +150							

NOTES:

1- Measured at 1 MHz and applied reverse voltage of 4.0 VDC.

2- Thermal resistance from junction to ambient mounted on P.C.B. with 0.3 x 0.3" (8.0 x 8.0mm) copper pad areas

3- Reverse Recovery Test Conditions : $I_F=0.5A$ $I_R=1A$ $I_{RR}=0.25A$.



Characteristic Curves ($T_A=25\text{ }^\circ\text{C}$ unless otherwise noted)

Fig.1 Forward Current Derating Curve

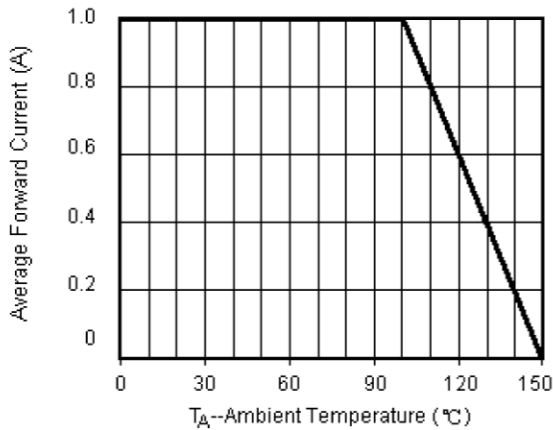

Fig.2 Maximum Non-Repetitive Peak Forward Surge Current

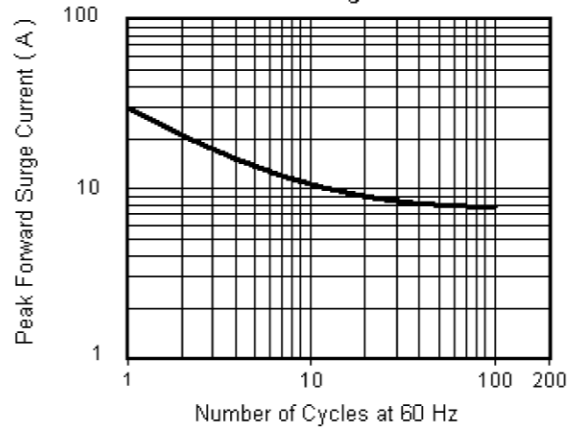

Fig.3 Typical Instantaneous Forward Characteristics

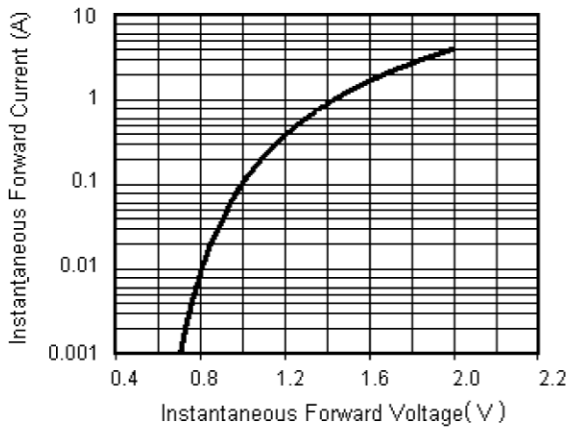

Fig.4 Typical Reverse Leakage Characteristics

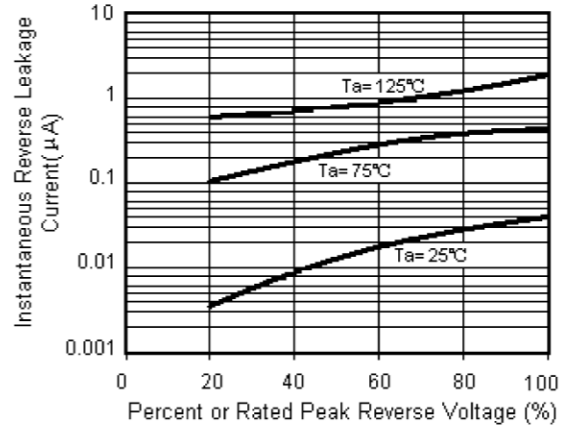

Fig.5 Typical Junction Capacitance

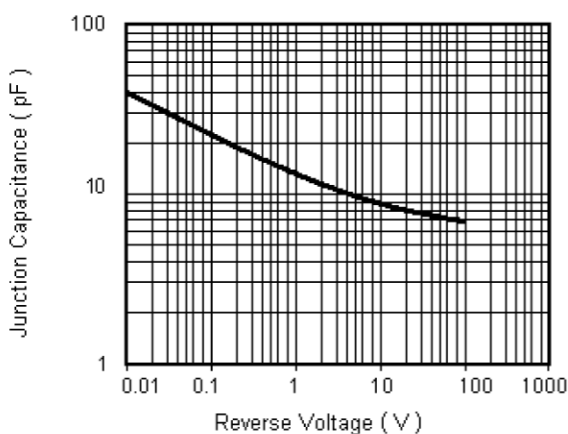
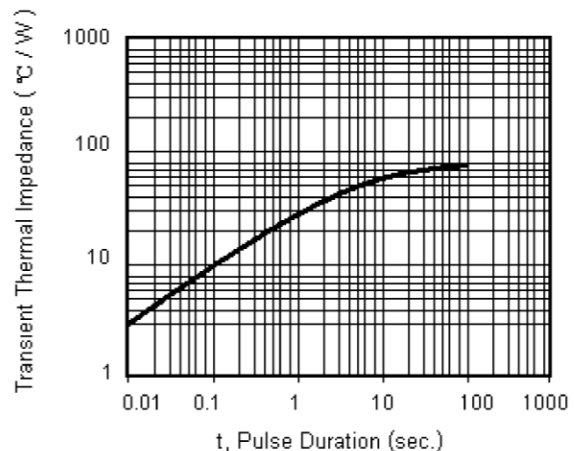

Fig.6 Transient Thermal Impedance



X-ON Electronics

Largest Supplier of Electrical and Electronic Components

Click to view similar products for [Diodes - General Purpose, Power, Switching category:](#)

Click to view products by [Juxing Electronic Technology manufacturer:](#)

Other Similar products are found below :

[MCL4151-TR3](#) [MMBD3004S-13-F](#) [RD0306T-H](#) [BAV17-TR](#) [BAV19-TR](#) [1N3611](#) [NTE156A](#) [NTE574](#) [NTE6244](#) [1SS181-TP](#)
[1SS400CST2RA](#) [SDAA13](#) [SHN2D02FUTW1T1G](#) [LS4151GS08](#) [1N4449](#) [1N456A](#) [1N4934-E3/73](#) [1N914B](#) [1N914BTR](#) [1SS226-TP](#)
[RFUH20TB3S](#) [D291S45T](#) [BAV300-TR](#) [BAW56DWQ-7-F](#) [BAW75-TAP](#) [MM230L-CAA](#) [IDW40E65D1](#) [JAN1N3600](#) [JAN1N4153-1](#)
[JAN1N4454-1](#) [JAN1N4454UR-1](#) [LL4151-GS18](#) [053684A](#) [SMMSD4148T3G](#) [707803H](#) [NSVDAN222T1G](#) [CDSZC01100-HF](#) [LL4150-M-08](#)
[1N4454-TR](#) [BAV199E6433HTMA1](#) [BAV70HDW-7](#) [BAS28-7](#) [JANTX1N6640](#) [BAW56HDW-13](#) [BAS28 TR](#) [VS-HFA04SD60STR-M3](#)
[NSVM1MA152WKT1G](#) [1SS388-TP](#) [RGP30D-E3/73](#) [VS-8EWF02S-M3](#)