



FEATURES

- Complementary to MMBT5401
- Ideal for Medium Power Amplification and Switching

MARKING: G1

MAXIMUM RATINGS ($T_a=25^\circ\text{C}$ unless otherwise noted)

Symbol	Parameter	Value	Unit
V_{CBO}	Collector-Base Voltage	180	V
V_{CEO}	Collector-Emitter Voltage	160	V
V_{EBO}	Emitter-Base Voltage	6	V
I_C	Collector Current	600	mA
P_C	Collector Power Dissipation	300	mW
$R_{\theta JA}$	Thermal Resistance From Junction To Ambient	416	$^\circ\text{C}/\text{W}$
T_j	Junction Temperature	150	$^\circ\text{C}$
T_{stg}	Storage Temperature	-55~+150	$^\circ\text{C}$

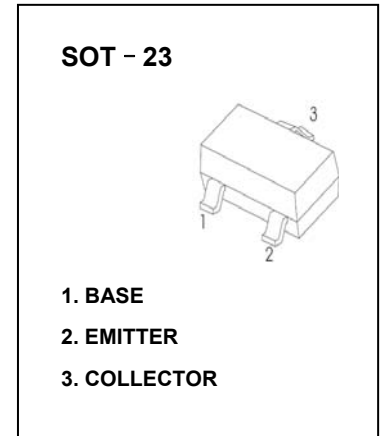

ELECTRICAL CHARACTERISTICS ($T_a=25^\circ\text{C}$ unless otherwise specified)

Parameter	Symbol	Test conditions	Min	Typ	Max	Unit
Collector-base breakdown voltage	$V_{(BR)CBO}$	$I_C=100\mu\text{A}, I_E=0$	180			V
Collector-emitter breakdown voltage	$V_{(BR)CEO}^*$	$I_C=1\text{mA}, I_B=0$	160			V
Emitter-base breakdown voltage	$V_{(BR)EBO}$	$I_E=10\mu\text{A}, I_C=0$	6			V
Collector cut-off current	I_{CBO}	$V_{CB}=120\text{V}, I_E=0$			50	nA
Emitter cut-off current	I_{EBO}	$V_{EB}=4\text{V}, I_C=0$			50	nA
DC current gain	$h_{FE(1)}^*$	$V_{CE}=5\text{V}, I_C=1\text{mA}$	80			
	$h_{FE(2)}^*$	$V_{CE}=5\text{V}, I_C=10\text{mA}$	100		300	
	$h_{FE(3)}^*$	$V_{CE}=5\text{V}, I_C=50\text{mA}$	50			
Collector-emitter saturation voltage	$V_{CE(sat)1}^*$	$I_C=10\text{mA}, I_B=1\text{mA}$			0.15	V
	$V_{CE(sat)2}^*$	$I_C=50\text{mA}, I_B=5\text{mA}$			0.2	V
Base-emitter saturation voltage	$V_{BE(sat)1}^*$	$I_C=10\text{mA}, I_B=1\text{mA}$			1	V
	$V_{BE(sat)2}^*$	$I_C=50\text{mA}, I_B=5\text{mA}$			1	V
Transition frequency	f_T	$V_{CE}=10\text{V}, I_C=10\text{mA}, f=100\text{MHz}$	100		300	MHz
Collector output capacitance	C_{ob}	$V_{CB}=10\text{V}, I_E=0, f=1\text{MHz}$			6	pF

*Pulse test: pulse width $\leq 300\mu\text{s}$, duty cycles $\leq 2.0\%$.

CLASSIFICATION OF $h_{FE(2)}$

RANK	L	H
RANGE	100-200	200-300





MMBT5551

TRANSISTOR (NPN)

Static Characteristic

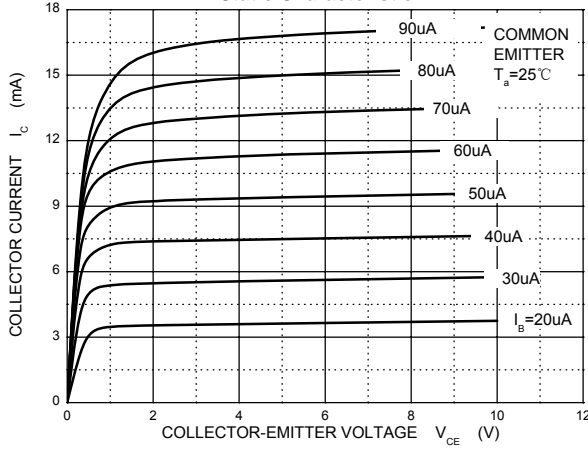

$h_{FE} - I_c$

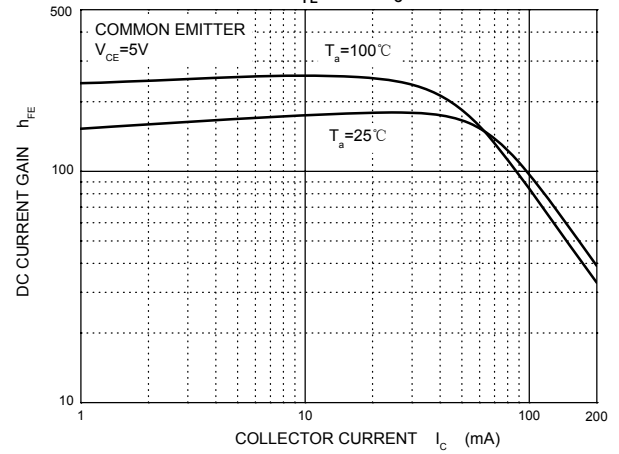

$V_{BEsat} - I_c$

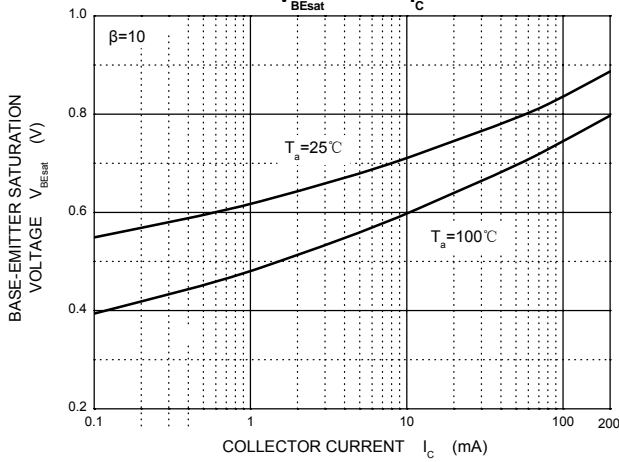

$V_{CEsat} - I_c$

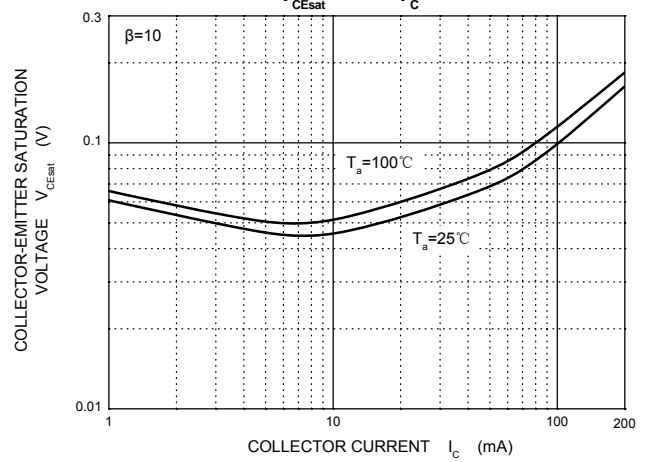

$V_{BE} - I_c$

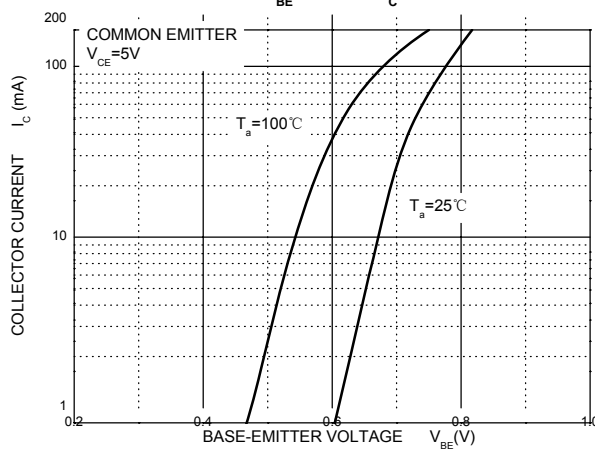

$C_{ob} / C_{ib} - V_{CB} / V_{EB}$

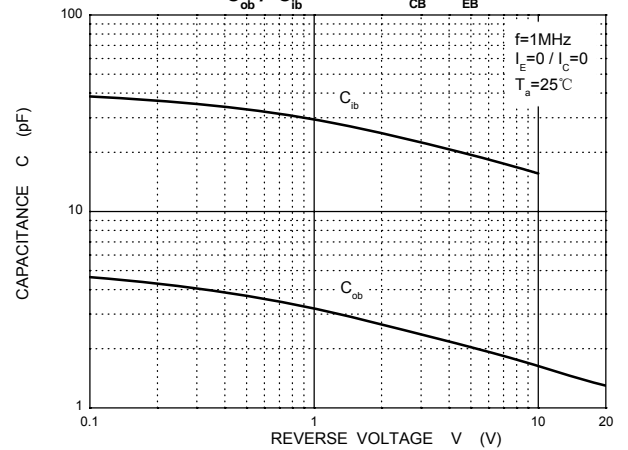

$f_T - I_c$

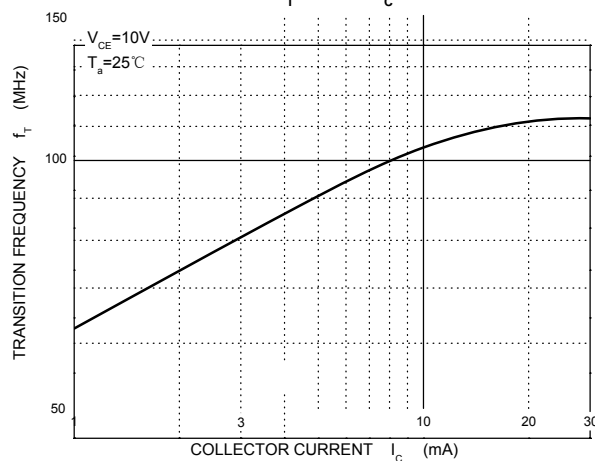

$P_c - T_a$

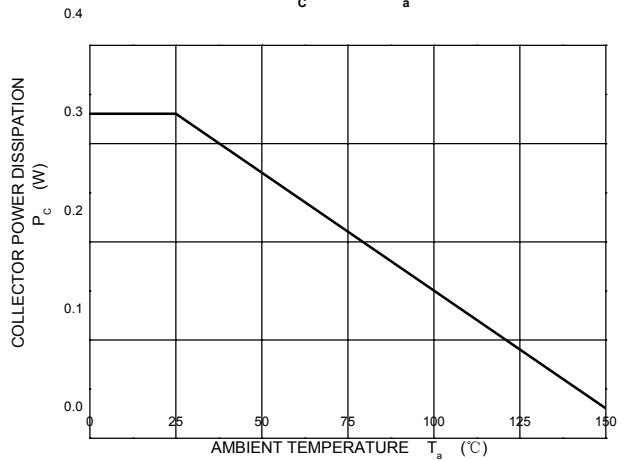

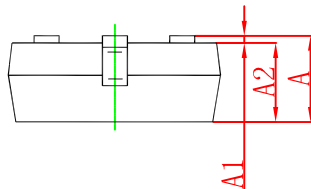
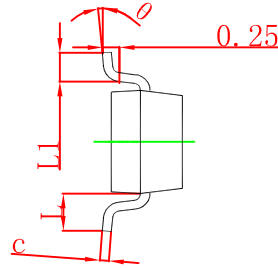
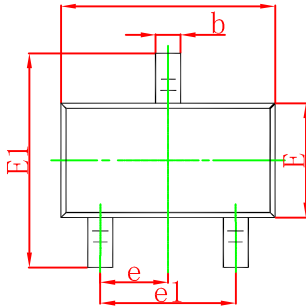

Symbol	Dimensions In Millimeters		Dimensions In Inches	
	Min	Max	Min	Max
A	0.900	1.150	0.035	0.045
A1	0.000	0.100	0.000	0.004
A2	0.900	1.050	0.035	0.041
b	0.300	0.500	0.012	0.020
c	0.080	0.150	0.003	0.006
D	2.800	3.000	0.110	0.118
E	1.200	1.400	0.047	0.055
E1	2.250	2.550	0.089	0.100
e	0.950 TYP		0.037 TYP	
e1	1.800	2.000	0.071	0.079
L	0.550 REF		0.022 REF	
L1	0.300	0.500	0.012	0.020
θ	0°	8°	0°	8°

SOT-23 Suggested Pad Layout

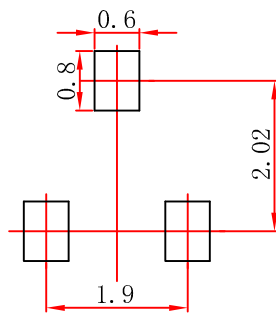

- Note:
1. Controlling dimension: in millimeters.
 2. General tolerance: $\pm 0.05\text{mm}$.
 3. The pad layout is for reference purposes only.

X-ON Electronics

Largest Supplier of Electrical and Electronic Components

Click to view similar products for [Bipolar Transistors - BJT category](#):

Click to view products by [Juxing Electronic Technology manufacturer](#):

Other Similar products are found below :

[BC559C](#) [MCH4017-TL-H](#) [MMBT-2369-TR](#) [BC546/116](#) [NJVMJD148T4G](#) [NTE16](#) [NTE195A](#) [IMX9T110](#) [2N4401-A](#) [2N4403](#) [2N6728](#)
[2SA1419T-TD-H](#) [2SA2126-E](#) [2SB1204S-TL-E](#) [FMC5AT148](#) [2N2369ADCSM](#) [2N2907A](#) [2N3904-NS](#) [2N5769](#) [2SC4618TLN](#) [CPH6501-](#)
[TL-E](#) [MCH4021-TL-E](#) [Jantx2N5416](#) [US6T6TR](#) [BAX18/A52R](#) [BC556/112](#) [IMZ2AT108](#) [MMST8098T146](#) [UMX21NTR](#) [MCH6102-TL-E](#)
[TTA1452B,S4X\(S](#) [2N3879](#) [NTE13](#) [NTE282](#) [NTE323](#) [NTE350](#) [NTE81](#) [JANTX2N2920L](#) [JANTX2N3735](#) [JANSR2N2222AUB](#)
[CMLT3946EG TR](#) [SNSS40600CF8T1G](#) [CMLT3906EG TR](#) [GRP-DATA-JANS2N2907AUB](#) [GRP-DATA-JANS2N2222AUA](#)
[MMDT3946FL3-7](#) [2N4240](#) [JANS2N3019](#) [MSB30KH-13](#) [2N2221AUB](#)