



# SF11 THRU SF18

## Superfast Recovery Rectifiers

### FEATURES

- High surge capability
- Low forward voltage, high current capability
- Hermetically sealed
- Superfast recovery times
- Exceeds environmental standards of MIL-S-19500/228
- Low leakage.

### MECHANICAL DATA

Case: Molded plastic, DO-41  
 Epoxy: UL 94V-O rate flame retardant  
 Lead: Axial leads, solderable per MIL-STD-202, method 208 guaranteed  
 Polarity: Color band denotes cathode end  
 Mounting position: Any  
 Weight: 0.012ounce, 0.33gram

### DO-41

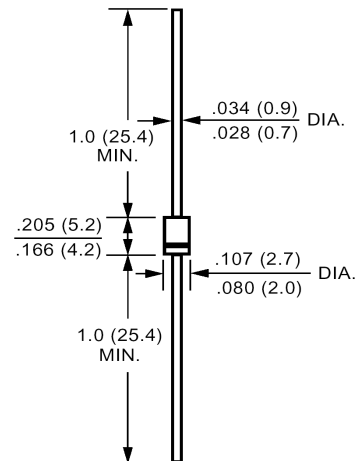

Dimensions in inches and (millimeters)

### Maximum Ratings and Electrical Characteristics

Ratings at 25 °C ambient temperature unless otherwise specified.  
 Single phase, half wave, 60Hz, resistive or inductive load.  
 For capacitive load, derate current by 20%.

	Symbols	SF11	SF12	SF13	SF14	SF15	SF16	SF18	Units	
Maximum Recurrent Peak Reverse Voltage	$V_{RRM}$	50	100	150	200	300	400	600	Volts	
Maximum RMS Voltage	$V_{RMS}$	35	70	105	140	210	280	420	Volts	
Maximum DC Blocking Voltage	$V_{DC}$	50	100	150	200	300	400	600	Volts	
Maximum Average Forward Rectified Current .375"(9.5mm) Lead Length at $T_A=55$	$I_{(AV)}$	1.0							Amp	
Peak Forward Surge Current, 8.3ms single half-sine-wave superimposed on rated load (JEDEC method)	$I_{FSM}$	30							Amp	
Maximum Forward Voltage at 1.0A DC and 25	$V_F$	1.0			1.25		1.65		Volts	
Maximum Reverse Current at $T_A=25$ at Rated DC Blocking Voltage $T_A=100$	$I_R$	5.0			500					uAmp
Typical Junction Capacitance (Note 1)	$C_J$	50			25					pF
Typical Thermal Resistance (Note 2)	$R_{\theta JA}$	50							/W	
Maximum Reverse Recovery Time (Note 3)	$T_{RR}$	35							nS	
Operating Junction Temperature Range	$T_J$	-55 to +125								
Storage Temperature Range	$T_{stg}$	-55 to +125								

### NOTES:

- 1- Measured at 1 MHz and applied reverse voltage of 4.0 VDC.
- 2- Thermal Resistance from Junction to Ambient 0.375"(9.5mm) lead length P.C.B. Mounted.
- 3- Reverse Recovery Test Conditions :  $I_F=.5A$  ,  $I_R=1A$  ,  $I_{RR}=.25A$ .



# SF11 THRU SF18

## Superfast Recovery Rectifiers

### RATINGS AND CHARACTERISTIC CURVES

FIG.1- REVERSE RECOVERY TIME CHARACTERISTIC AND TEST CIRCUIT DIAGRAM

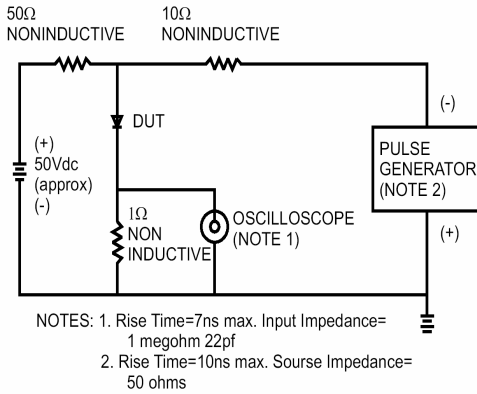

FIG.2- MAXIMUM AVERAGE FORWARD CURRENT DERATING

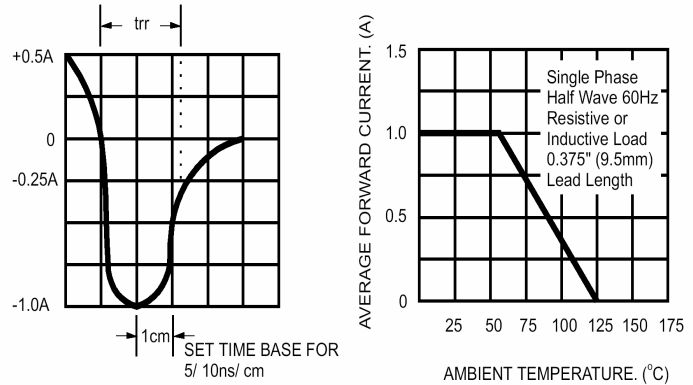

FIG.3- TYPICAL REVERSE CHARACTERISTICS

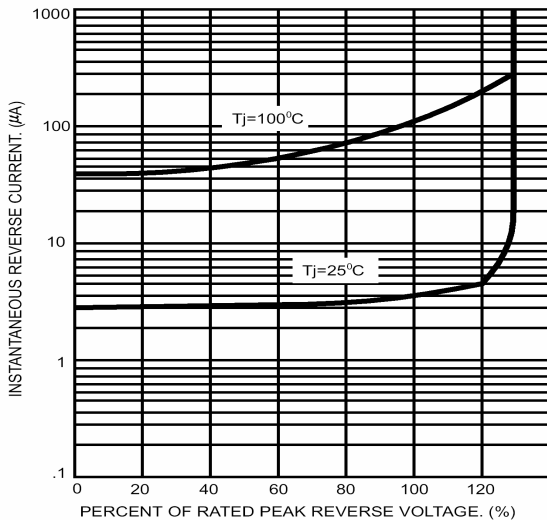

FIG.4- TYPICAL FORWARD CHARACTERISTICS

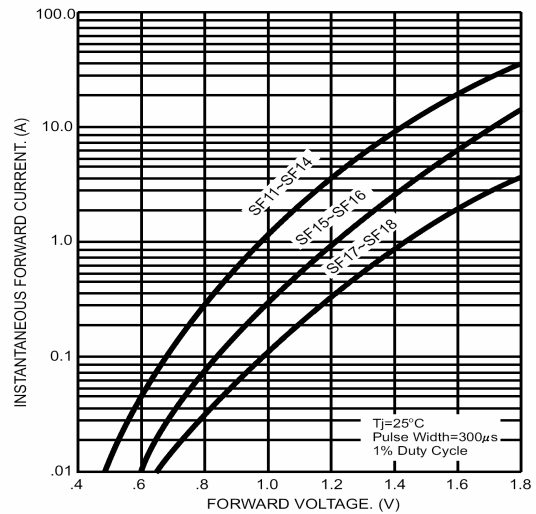

FIG.5- MAXIMUM NON-REPETITIVE FORWARD SURGE CURRENT

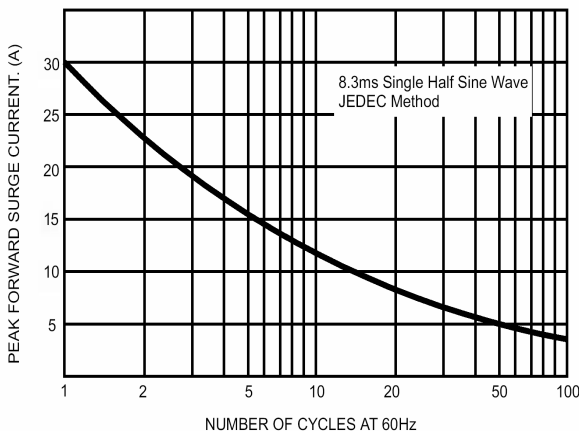
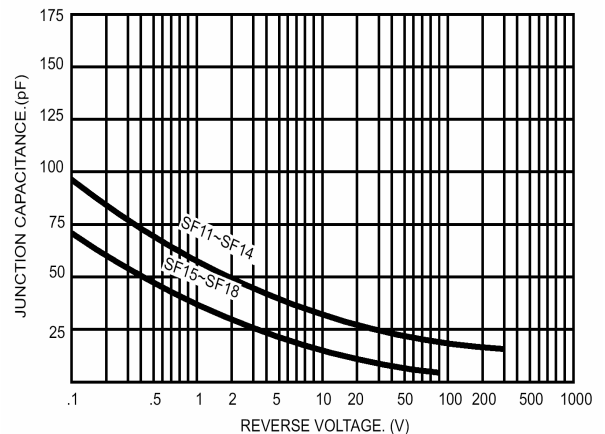

FIG.6- TYPICAL JUNCTION CAPACITANCE



## X-ON Electronics

Largest Supplier of Electrical and Electronic Components

*Click to view similar products for [Rectifiers](#) category:*

*Click to view products by [Juxing Electronic Technology](#) manufacturer:*

Other Similar products are found below :

[70HFR40](#) [FR105 R0](#) [RL252-TP](#) [1N5397](#) [1N4005-TR](#) [1N4007-BP](#) [UFS120Je3/TR13](#) [20ETS12S](#) [RRE02VS6SGTR](#) [MS306](#) [A1N5404G-G](#)  
[CRF02\(T5L,TEMQ\)](#) [ACGRB207-HF](#) [CLH07\(TE16L,Q\)](#) [CLH03\(TE16L,Q\)](#) [1N5395-TP](#) [UES1302](#) [ACGRC307-HF](#) [ACEFC304-HF](#) [DZ-](#)  
[1380](#) [85HFR60](#) [40HFR60](#) [70HF120](#) [85HFR80](#) [SCF7500](#) [SM100](#) [ACGRA4001-HF](#) [SKN70/08](#) [NTE5819](#) [NTE5827](#) [NTE5828](#) [NTE5911](#)  
[NTE5915](#) [NTE6104](#) [NTE6163](#) [NTE6164](#) [NTE6165](#) [NTE6364](#) [TSD3G](#) [SET130312](#) [NRVUS110VT3G](#) [UES1106](#) [UES1306](#)  
[NRVUS240VT3G](#) [D5FE60-5063](#) [R4000GPS-TP](#) [D4015L56TP](#) [UES1306HR2](#) [FX20K120](#) [D20XB60-7101](#)