



SF21G THRU SF28G

Superfast Recovery Rectifiers

FEATURES

- Glass Passivated chip junction
- High surge capability
- Low forward voltage, high current capability
- Hermetically sealed
- Superfast recovery times
- Exceeds environmental standards of MIL-S-19500/228
- Low leakage.

MECHANICAL DATA

Case: Molded plastic, DO-15

Epoxy: UL 94V-O rate flame retardant

Lead: Axial leads, solderable per MIL-STD-202, method 208 guaranteed

Polarity: Color band denotes cathode end

Mounting position: Any

Weight: 0.015ounce, 0.4gram

DO-15

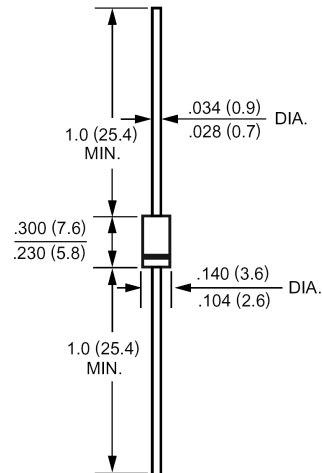

Dimensions in inches and (millimeters)

Maximum Ratings and Electrical Characteristics

Ratings at 25 °C ambient temperature unless otherwise specified.

Single phase, half wave, 60Hz, resistive or inductive load.

For capacitive load, derate current by 20%.

	Symbols	SF21G	SF22G	SF23G	SF24G	SF25G	SF26G	SF28G	Units	
Maximum Recurrent Peak Reverse Voltage	V_{RRM}	50	100	150	200	300	400	600	Volts	
Maximum RMS Voltage	V_{RMS}	35	70	105	140	210	280	420	Volts	
Maximum DC Blocking Voltage	V_{DC}	50	100	150	200	300	400	600	Volts	
Maximum Average Forward Rectified Current .375"(9.5mm) Lead Length at $T_A=55$	$I_{(AV)}$	2.0							Amp	
Peak Forward Surge Current, 8.3ms single half-sine-wave superimposed on rated load (JEDEC method)	I_{FSM}	50							Amp	
Maximum Forward Voltage at 2.0A DC and 25	V_F	1.0			1.25		1.65		Volts	
Maximum Reverse Current at $T_A=25$ at Rated DC Blocking Voltage $T_A=100$	I_R	5.0				500				uAmp
Typical Junction Capacitance (Note 1)	C_J	60			30				pF	
Typical Thermal Resistance (Note 2)	$R_{\theta JA}$	40							/W	
Maximum Reverse Recovery Time (Note 3)	T_{RR}	35							nS	
Operating Junction Temperature Range	T_J	-55 to +150								
Storage Temperature Range	T_{stg}	-55 to +150								

NOTES:

1- Measured at 1 MHz and applied reverse voltage of 4.0 VDC.

2- Thermal Resistance from Junction to Ambient 0.375"(9.5mm) lead length P.C.B. Mounted.

3- Reverse Recovery Test Conditions : $I_F=.5A$, $I_R=1A$, $I_{RR}=.25A$.



SF21G THRU SF28G

Superfast Recovery Rectifiers

RATINGS AND CHARACTERISTIC CURVES

FIG.1- REVERSE RECOVERY TIME CHARACTERISTIC AND TEST CIRCUIT DIAGRAM

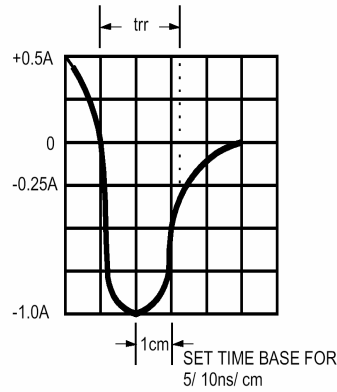
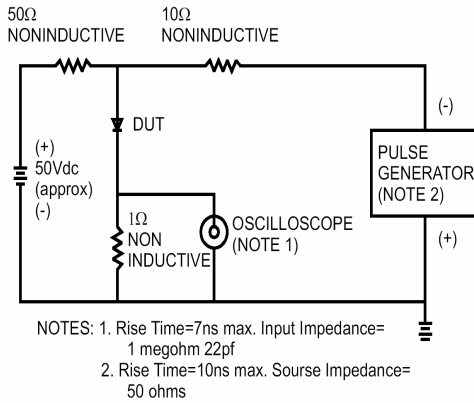

FIG.2- MAXIMUM AVERAGE FORWARD CURRENT DERATING

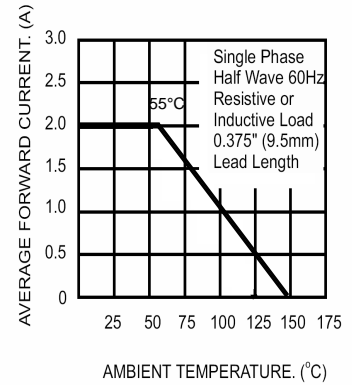

FIG.3- TYPICAL REVERSE CHARACTERISTICS

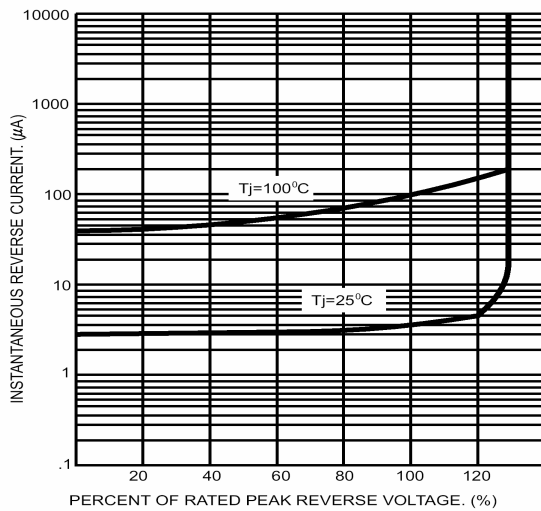

FIG.4- TYPICAL FORWARD CHARACTERISTICS

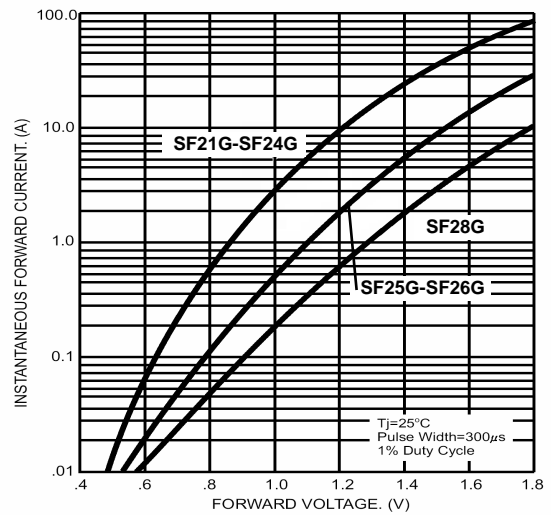

FIG.5- MAXIMUM NON-REPETITIVE FORWARD SURGE CURRENT

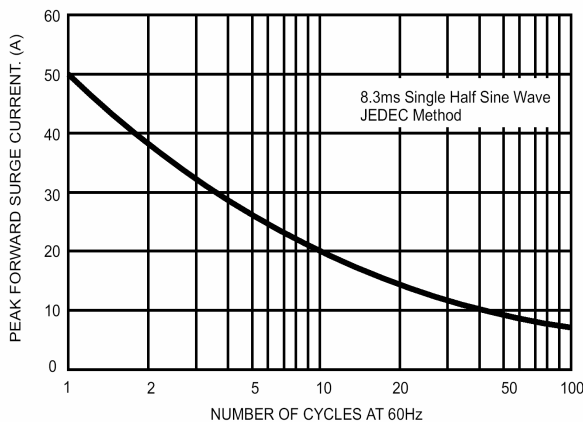
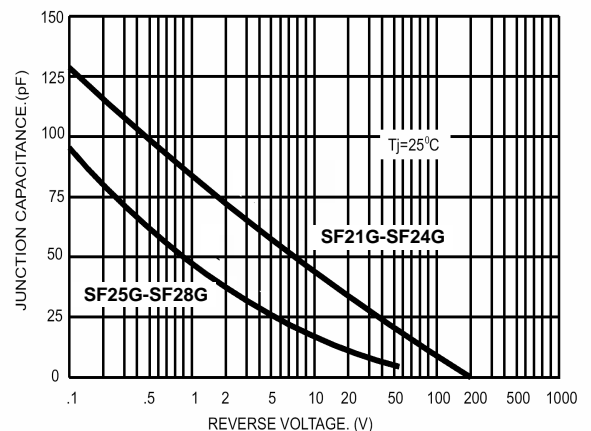

FIG.6- TYPICAL JUNCTION CAPACITANCE



X-ON Electronics

Largest Supplier of Electrical and Electronic Components

Click to view similar products for [Rectifiers](#) category:

Click to view products by [Juxing Electronic Technology](#) manufacturer:

Other Similar products are found below :

[70HFR40](#) [FR105 R0](#) [RL252-TP](#) [1N5397](#) [1N4005-TR](#) [1N4007-BP](#) [UFS120Je3/TR13](#) [20ETS12S](#) [RRE02VS6SGTR](#) [MS306](#) [A1N5404G-G](#)
[CRF02\(T5L,TEMQ\)](#) [ACGRB207-HF](#) [CLH07\(TE16L,Q\)](#) [CLH03\(TE16L,Q\)](#) [1N5395-TP](#) [UES1302](#) [ACGRC307-HF](#) [ACEFC304-HF](#) [DZ-](#)
[1380](#) [85HFR60](#) [40HFR60](#) [70HF120](#) [85HFR80](#) [SCF7500](#) [SM100](#) [ACGRA4001-HF](#) [SKN70/08](#) [NTE5819](#) [NTE5827](#) [NTE5828](#) [NTE5911](#)
[NTE5915](#) [NTE6104](#) [NTE6163](#) [NTE6164](#) [NTE6165](#) [NTE6364](#) [TSD3G](#) [SET130312](#) [NRVUS110VT3G](#) [UES1106](#) [UES1306](#)
[NRVUS240VT3G](#) [D5FE60-5063](#) [R4000GPS-TP](#) [D4015L56TP](#) [UES1306HR2](#) [FX20K120](#) [D20XB60-7101](#)