



SFF1602 THRU SFF1606

Superfast Recovery Rectifiers

FEATURES

- ◆ Ultrafast 35 Nanosecond Recovery Time
- ◆ 150° C Operating Junction Temperature
- ◆ Popular ITO-220 AB Package
- ◆ Epoxy Meets UL94 ,V0 @ 1/8"
- ◆ High Temperature Glass Passivated Junction
- ◆ Low Forward Voltage
- ◆ Low Leakage Current
- ◆ Reverse Voltage to 600 Volts
- ◆ Pb-Free Packages are Available

MECHANICAL DATA

- Case: Epoxy, Molded
- Finish: All External Surfaces Corrosion Resistant and Terminal Leads are Readily Solderable
- Lead Temperature for Soldering Purposes: 260° C Max. for 10 Seconds
- Shipped 50 units per plastic tube

ITO-220AB

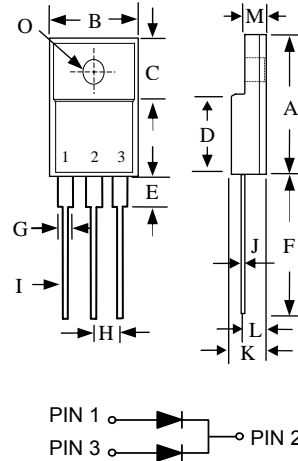

ITO-220AB		
DIM.	MIN.	MAX.
A	14.90	15.90
B	9.90	10.40
C	6.45	7.15
D	7.85	8.75
E	2.90	3.90
F	12.8	—
G	1.10	1.4
H	2.35	2.55
I	0.45	0.95
J	0.40	0.65
K	4.35	4.75
L	2.55	3.15
M	2.60	3.10
O	∅3.00	∅3.50

All Dimensions in millimeter

Maximum Ratings and Electrical Characteristics

Ratings at 25°C ambient temperature unless otherwise specified.
 Single phase, half wave, 60Hz, resistive or inductive load.
 For capacitive load, derate current by 20%.

Type Number	Symbol	SFF1602	SFF1604	SFF1606	Units
Maximum Recurrent Peak Reverse Voltage	V_{RRM}	200	400	600	V
Maximum RMS Voltage	V_{RMS}	140	280	420	V
Maximum DC Blocking Voltage	V_{DC}	200	400	600	V
Maximum Average Forward Rectified Current @ $T_C = 100^\circ C$	$I_{(AV)}$	16			A
Peak Forward Surge Current, 8.3 ms Single Half Sine-wave Superimposed on Rated Load (JEDEC method)	I_{FSM}	150			A
Maximum Instantaneous Forward Voltage @ 8.0A	V_F	0.975	1.30	1.70	V
Maximum DC Reverse Current @ $T_A=25^\circ C$ at Rated DC Blocking Voltage @ $T_A=100^\circ C$	I_R	10 400			uA uA
Maximum Reverse Recovery Time (Note 1)	T_{rr}	35			nS
Typical Junction Capacitance (Note 2)	C_j	80	60		pF
Typical Thermal Resistance (Note 3)	$R_{\theta JC}$	1.5			°C/W
Operating Temperature Range	T_J	-65 to +150			°C
Storage Temperature Range	T_{STG}	-65 to +150			°C

- Notes: 1. Reverse Recovery Test Conditions: $I_F=0.5A$, $I_R=1.0A$, $I_{RR}=0.25A$
 2. Measured at 1 MHz and Applied Reverse Voltage of 4.0 V D.C.
 3. Mounted on Heatsink Size of 3" x 5" x 0.25" Al-Plate.



SFF1602 THRU SFF1606

Superfast Recovery Rectifiers

Characteristic Curves ($T_A=25^\circ\text{C}$ unless otherwise noted)

FIG.1- MAXIMUM FORWARD CURRENT DERATING CURVE

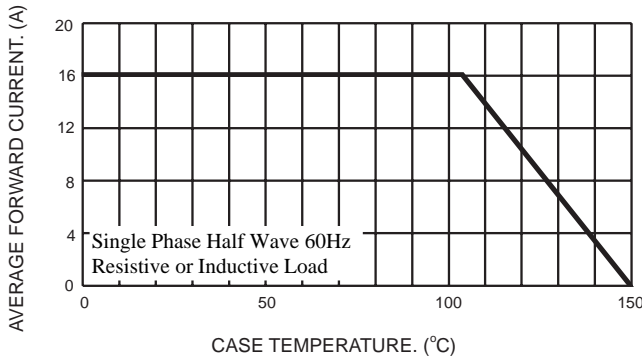

FIG.2- TYPICAL REVERSE CHARACTERISTICS

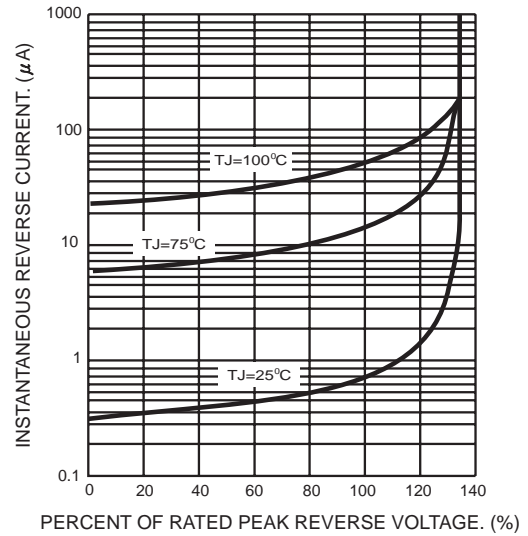

FIG.3- MAXIMUM NON-REPETITIVE FORWARD SURGE CURRENT PER LEG

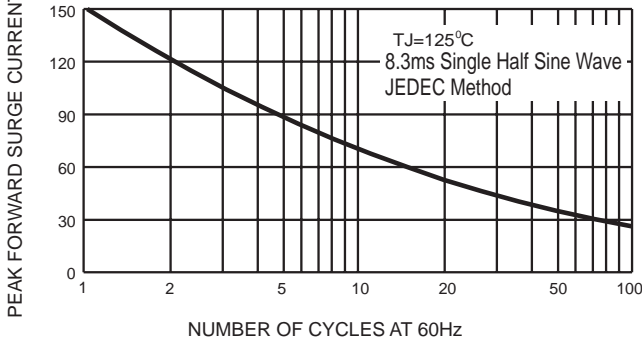

FIG.5- TYPICAL FORWARD CHARACTERISTICS PER LEG

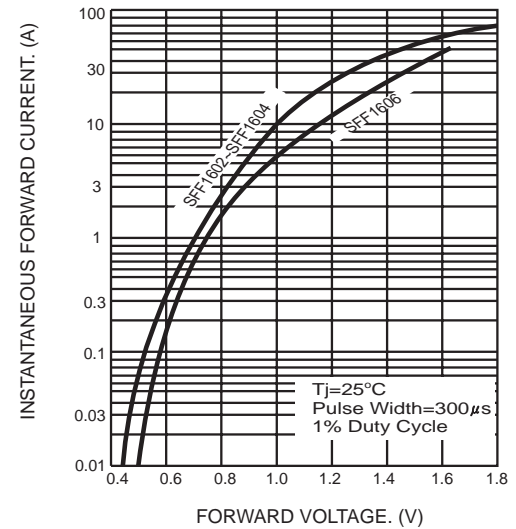

FIG.4- TYPICAL JUNCTION CAPACITANCE PER LEG

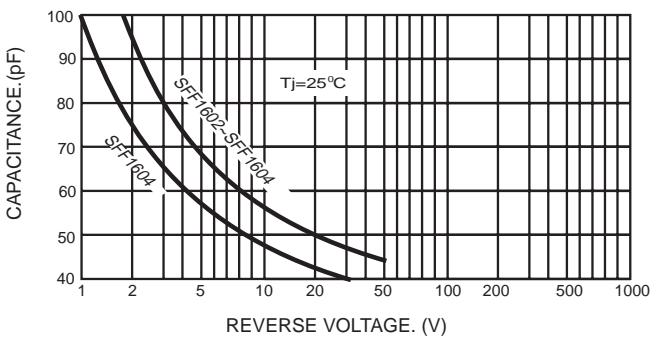
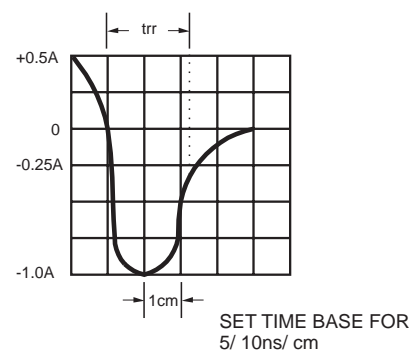
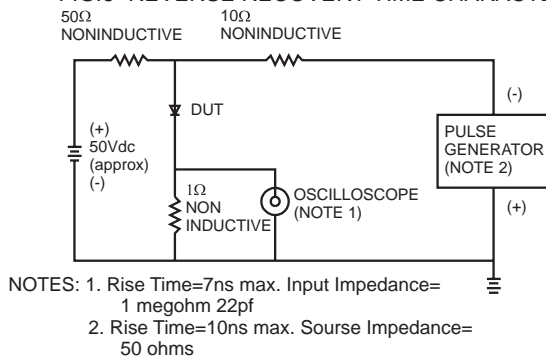

FIG.6- REVERSE RECOVERY TIME CHARACTERISTIC AND TEST CIRCUIT DIAGRAM



X-ON Electronics

Largest Supplier of Electrical and Electronic Components

Click to view similar products for [Rectifiers](#) category:

Click to view products by [Juxing Electronic Technology](#) manufacturer:

Other Similar products are found below :

[70HFR40](#) [FR105 R0](#) [RL252-TP](#) [1N5397](#) [1N4005-TR](#) [1N4007-BP](#) [UFS120Je3/TR13](#) [20ETS12S](#) [RRE02VS6SGTR](#) [MS306](#) [A1N5404G-G](#)
[CRF02\(T5L,TEMQ\)](#) [ACGRB207-HF](#) [CLH07\(TE16L,Q\)](#) [CLH03\(TE16L,Q\)](#) [1N5395-TP](#) [UES1302](#) [ACGRC307-HF](#) [ACEFC304-HF](#) [DZ-](#)
[1380](#) [85HFR60](#) [40HFR60](#) [70HF120](#) [85HFR80](#) [SCF7500](#) [SM100](#) [ACGRA4001-HF](#) [SKN70/08](#) [NTE5819](#) [NTE5827](#) [NTE5828](#) [NTE5911](#)
[NTE5915](#) [NTE6104](#) [NTE6163](#) [NTE6164](#) [NTE6165](#) [NTE6364](#) [TSD3G](#) [SET130312](#) [NRVUS110VT3G](#) [UES1106](#) [UES1306](#)
[NRVUS240VT3G](#) [D5FE60-5063](#) [R4000GPS-TP](#) [D4015L56TP](#) [UES1306HR2](#) [FX20K120](#) [D20XB60-7101](#)