



# SMBJ Series

## Surface Mount Transient Voltage Suppressor Power 600W

**Stand-Off Voltage : 5.0V~440V**

### FEATURES

- For surface mounted applications in order to optimize board space.
- Low profile package
- Glass passivated junction
- Low inductance
- Plastic package has Underwriters Laboratory Flammability

### MECHANICAL DATA

- Case: SMB
- Terminals: Solderable per MIL-STD-750, Method 2026
- Approx. Weight: 0.055g / 0.002oz

### PINNING

| PIN | DESCRIPTION |
|-----|-------------|
| 1   | Cathode     |
| 2   | Anode       |

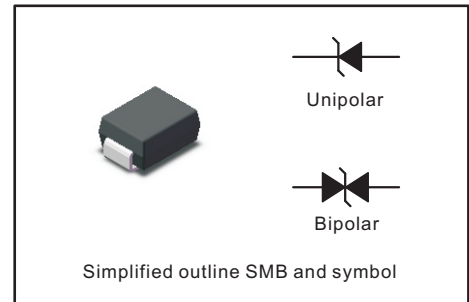

### Maximum Ratings and Electrical characteristics

Ratings at 25 °C ambient temperature unless otherwise specified.

| Parameter  | Symbol             | Value                    | Unit                 |    |
|--|--------------------|--------------------------|----------------------|----|
| Peak Pulse Power Dissipation on 10/1000 s waveform (Note1,Note2, Fig.1).   | $P_{PPM}$          | 600                      | W                    |    |
| Peak Forward Surge Current,8.3ms Single Half Sine-Wave Superimposed on Rated Load, (JEDEC Method) (Note 3,Fig4). | $I_{FSM}$<br>(UNI) | 100                      | A                    |    |
| Peak Pulse Current on 10/1000 us waveform (Note 1, Fig 3)  | $I_{PPM}$          | see Table 1              | A                    |    |
| Typical Junction capacitance at VR=4V, f=1MHz  | $C_J$              | 390                      | pF                   |    |
| ESD Voltage per IEC6100-4-2  | Contact<br>Air     | $V_{ESD1}$<br>$V_{ESD2}$ | $\pm 30$<br>$\pm 30$ | kV |
| Typical Thermal Resistance Junction to Ambient(Note 2)   | $R_{\theta JA}$    | 100                      | °C/W                 |    |
| Operating Junction Temperature and Storage Temperature Range   | $T_j, T_{stg}$     | -65 ~ +150               | °C                   |    |

### NOTES:

1. Non-repetitive current pulse, per Fig.3 and derated above  $T_A = 25^\circ\text{C}$  per Fig. 2.
2. Mounted on  $5\text{ mm}^2$  (0.13mm thick) land areas.
3. Measured on 8.3ms, single half sine-wave or equivalent square wave, duty cycle=4 pulses per minute maximum.
4. Peak pulse power waveform is 10/1000 $\mu\text{S}$ .

| Type                                    |            | Reverse Stand-off Voltage | Breakdown Voltage                |      | Test Current   | Maximum Reverse Leakage | Max. Clamp Voltage               | Peak Pulse Current | Package |    |
|---|------------|---------------------------|----------------------------------|------|----------------|-------------------------|----------------------------------|--------------------|---------|----|
|   |            |                           | V <sub>BR</sub> @ I <sub>T</sub> |      |                |                         |                                  |                    | SMB     |    |
| UNI                                     | BI         | V <sub>RMW</sub>          | Min                              | Max  | I <sub>T</sub> |                         | V <sub>C</sub> @ I <sub>PP</sub> | I <sub>PP</sub>    | UNI     | BI |
|   |            | V                         | V                                | V    | mA             | µA                      | V                                | A                  |         |    |
| <b>600W Transient Voltage Suppresso</b> |            |                           |                                  |      |                |                         |                                  |                    |         |    |
| SMBJ5.0A                                | SMBJ5.0CA  | 5                         | 6.4                              | 7    | 10             | 800                     | 9.2                              | 65.3               | KE      | AE |
| SMBJ6.0A                                | SMBJ6.0CA  | 6                         | 6.67                             | 7.37 | 10             | 800                     | 10.3                             | 58.3               | KG      | AG |
| SMBJ6.5A                                | SMBJ6.5CA  | 6.5                       | 7.22                             | 7.98 | 10             | 500                     | 11.2                             | 53.6               | KK      | AK |
| SMBJ7.0A                                | SMBJ7.0CA  | 7                         | 7.78                             | 8.6  | 10             | 200                     | 12.0                             | 50.0               | KM      | AM |
| SMBJ7.5A                                | SMBJ7.5CA  | 7.5                       | 8.33                             | 9.21 | 1              | 100                     | 12.9                             | 46.6               | KP      | AP |
| SMBJ8.0A                                | SMBJ8.0CA  | 8                         | 8.89                             | 9.83 | 1              | 50                      | 13.6                             | 44.2               | KR      | AR |
| SMBJ8.5A                                | SMBJ8.5CA  | 8.5                       | 9.44                             | 10.4 | 1              | 20                      | 14.4                             | 41.7               | KT      | AT |
| SMBJ9.0A                                | SMBJ9.0CA  | 9                         | 10                               | 11.1 | 1              | 10                      | 15.4                             | 39.0               | KV      | AV |
| SMBJ10A                                 | SMBJ10CA   | 10                        | 11.1                             | 12.3 | 1              | 5                       | 17.0                             | 35.3               | KX      | AX |
| SMBJ11A                                 | SMBJ11CA   | 11                        | 12.2                             | 13.5 | 1              | 1                       | 18.2                             | 33.0               | KZ      | AZ |
| SMBJ12A                                 | SMBJ12CA   | 12                        | 13.3                             | 14.7 | 1              | 1                       | 19.9                             | 30.2               | LE      | BE |
| SMBJ13A                                 | SMBJ13CA   | 13                        | 14.4                             | 15.9 | 1              | 1                       | 21.5                             | 28.0               | LG      | BG |
| SMBJ14A                                 | SMBJ14CA   | 14                        | 15.6                             | 17.2 | 1              | 1                       | 23.2                             | 25.9               | LK      | BK |
| SMBJ15A                                 | SMBJ15CA   | 15                        | 16.7                             | 18.5 | 1              | 1                       | 24.4                             | 24.6               | LM      | BM |
| SMBJ16A                                 | SMBJ16CA   | 16                        | 17.8                             | 19.7 | 1              | 1                       | 26.0                             | 23.1               | LP      | BP |
| SMBJ17A                                 | SMBJ17CA   | 17                        | 18.9                             | 20.9 | 1              | 1                       | 27.6                             | 21.8               | LR      | BR |
| SMBJ18A                                 | SMBJ18CA   | 18                        | 20                               | 22.1 | 1              | 1                       | 29.2                             | 20.6               | LT      | BT |
| SMBJ20A                                 | SMBJ20CA   | 20                        | 22.2                             | 24.5 | 1              | 1                       | 32.4                             | 18.6               | LV      | BV |
| SMBJ22A                                 | SMBJ22CA   | 22                        | 24.4                             | 26.9 | 1              | 1                       | 35.5                             | 16.9               | LX      | BX |
| SMBJ24A                                 | SMBJ24CA   | 24                        | 26.7                             | 29.5 | 1              | 1                       | 38.9                             | 15.5               | LZ      | BZ |
| SMBJ26A                                 | SMBJ26CA   | 26                        | 28.9                             | 31.9 | 1              | 1                       | 42.1                             | 14.3               | ME      | CE |
| SMBJ28A                                 | SMBJ28CA   | 28                        | 31.1                             | 34.4 | 1              | 1                       | 45.4                             | 13.3               | MG      | CG |
| SMBJ30A                                 | SMBJ30CA   | 30                        | 33.3                             | 36.8 | 1              | 1                       | 48.4                             | 12.4               | MK      | CK |
| SMBJ33A                                 | SMBJ33CA   | 33                        | 36.7                             | 40.6 | 1              | 1                       | 53.3                             | 11.3               | MM      | CM |
| SMBJ36A                                 | SMBJ36CA   | 36                        | 40                               | 44.2 | 1              | 1                       | 58.1                             | 10.4               | MP      | CP |
| SMBJ40A                                 | SMBJ40CA   | 40                        | 44.4                             | 49.1 | 1              | 1                       | 64.5                             | 9.3                | MR      | CR |
| SMBJ43A                                 | SMBJ43CA   | 43                        | 47.8                             | 52.8 | 1              | 1                       | 69.4                             | 8.7                | MT      | CT |
| SMBJ45A                                 | SMBJ45CA   | 45                        | 50                               | 55.3 | 1              | 1                       | 72.7                             | 8.3                | MV      | CV |
| SMBJ48A                                 | SMBJ48CA   | 48                        | 53.3                             | 58.9 | 1              | 1                       | 77.4                             | 7.8                | MX      | CX |
| SMBJ51A                                 | SMBJ51CA   | 51                        | 56.7                             | 62.7 | 1              | 1                       | 82.4                             | 7.3                | MZ      | CZ |
| SMBJ54A                                 | SMBJ54CA   | 54                        | 60                               | 66.3 | 1              | 1                       | 87.1                             | 6.9                | NE      | DE |
| SMBJ58A                                 | SMBJ58CA   | 58                        | 64.4                             | 71.2 | 1              | 1                       | 93.6                             | 6.5                | NG      | DG |
| SMBJ60A                                 | SMBJ60CA   | 60                        | 66.7                             | 73.7 | 1              | 1                       | 96.8                             | 6.2                | NK      | DK |
| SMBJ64A                                 | SMBJ64CA   | 64                        | 71.1                             | 78.6 | 1              | 1                       | 103.0                            | 5.9                | NM      | DM |
| SMBJ70A                                 | SMBJ70CA   | 70                        | 77.8                             | 86   | 1              | 1                       | 113.0                            | 5.3                | NP      | DP |
| SMBJ75A                                 | SMBJ75CA   | 75                        | 83.3                             | 92.1 | 1              | 1                       | 121.0                            | 5.0                | NR      | DR |
| SMBJ78A                                 | SMBJ78CA   | 78                        | 86.7                             | 95.8 | 1              | 1                       | 126.0                            | 4.8                | NT      | DT |
| SMBJ85A                                 | SMBJ85CA   | 85                        | 94.4                             | 104  | 1              | 1                       | 137.0                            | 4.4                | NV      | DV |
| SMBJ90A                                 | SMBJ90CA   | 90                        | 100                              | 111  | 1              | 1                       | 146.0                            | 4.1                | NX      | DX |
| SMBJ100A                                | SMBJ100CA  | 100                       | 111                              | 123  | 1              | 1                       | 162.0                            | 3.7                | NZ      | DZ |
| SMBJ110A                                | SMBJ110CA  | 110                       | 122                              | 135  | 1              | 1                       | 177.0                            | 3.4                | PE      | EE |
| SMBJ120A                                | SMBJ120CA  | 120                       | 133                              | 147  | 1              | 1                       | 193.0                            | 3.1                | PG      | EG |
| SMBJ130A                                | SMBJ130CA  | 130                       | 144                              | 159  | 1              | 1                       | 209.0                            | 2.9                | PK      | EK |
| SMBJ150A                                | SMBJ150CA  | 150                       | 167                              | 185  | 1              | 1                       | 243.0                            | 2.5                | PM      | EM |
| SMBJ160A                                | SMBJ160CA  | 160                       | 178                              | 197  | 1              | 1                       | 259.0                            | 2.3                | PP      | EP |
| SMBJ170A                                | SMBJ170CA  | 170                       | 189                              | 209  | 1              | 1                       | 275.0                            | 2.2                | PR      | ER |
| SMBJ180A                                | SMBJ180CA  | 180                       | 201                              | 222  | 1              | 1                       | 292.0                            | 2.1                | PT      | ET |
| SMBJ188A                                | SMBJ188CA  | 188                       | 209                              | 231  | 1              | 1                       | 304.0                            | 2.0                | PB      | EB |
| SMBJ200A                                | SMBJ200CA  | 200                       | 224                              | 247  | 1              | 1                       | 324.0                            | 1.9                | PV      | EV |
| SMBJ220A                                | SMBJ220CA  | 220                       | 246                              | 272  | 1              | 1                       | 356.0                            | 1.7                | PX      | EX |
| SMBJ250A                                | SMBJ250CA  | 250                       | 279                              | 309  | 1              | 1                       | 405.0                            | 1.5                | PZ      | EZ |
| SMBJ300A*                               | SMBJ300CA* | 300                       | 335                              | 371  | 1              | 1                       | 486.0                            | 1.3                | QE      | FE |
| SMBJ350A*                               | SMBJ350CA* | 350                       | 391                              | 432  | 1              | 1                       | 567.0                            | 1.1                | QG      | FG |
| SMBJ400A*                               | SMBJ400CA* | 400                       | 447                              | 494  | 1              | 1                       | 648.0                            | 0.9                | QK      | FK |
| SMBJ440A*                               | SMBJ440CA* | 440                       | 492                              | 543  | 1              | 1                       | 713.0                            | 0.9                | QM      | FM |



**Characteristic Curves** ( $T_A=25\text{ }^\circ\text{C}$  unless otherwise noted)

**Fig.1 Peak Pulse Power Rating Curve**

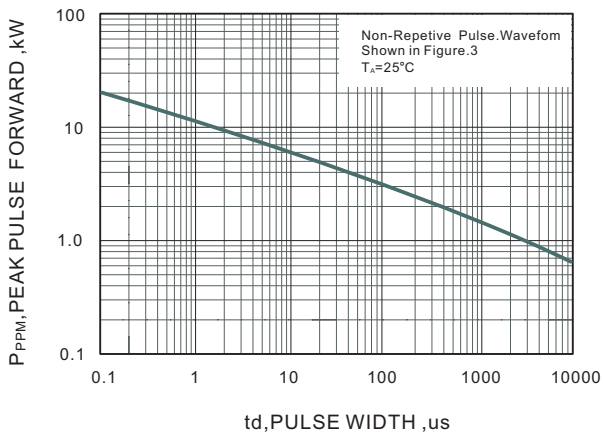

**Fig.2 Forward Current Derating Curve**

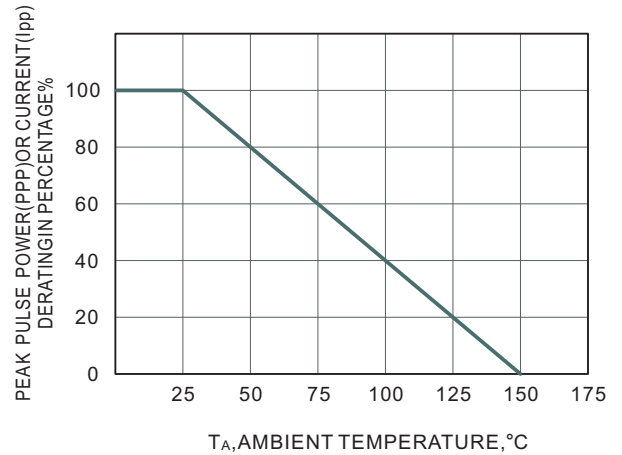

**Fig.3 Pulse Waveform**

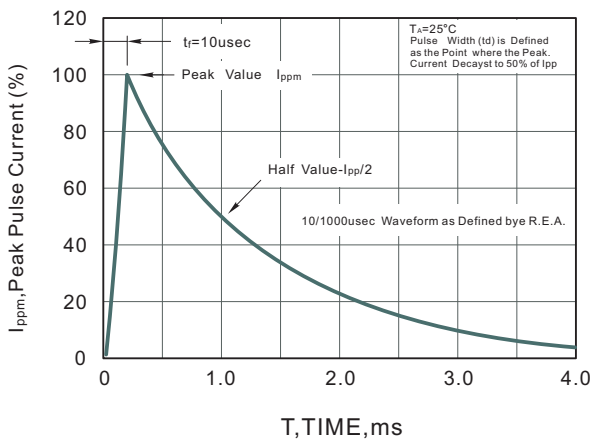

**Fig.4 Maximum Non-Repetitive Peak Forward Surge Current**

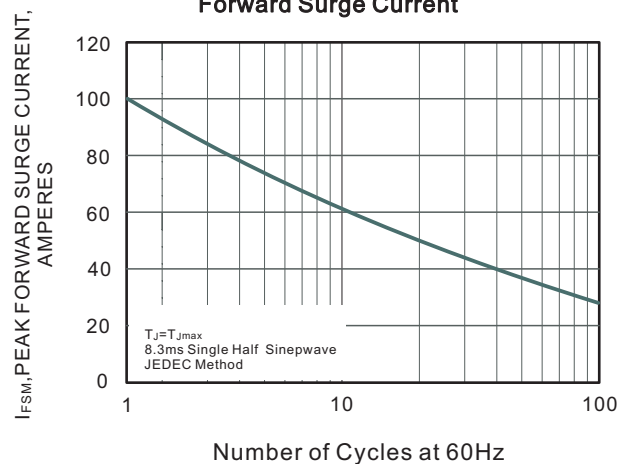



# SMBJ Series

## Surface Mount Transient Voltage Suppressor Power 600W

### PACKAGE OUTLINE

Plastic surface mounted package; 2 leads

SMB

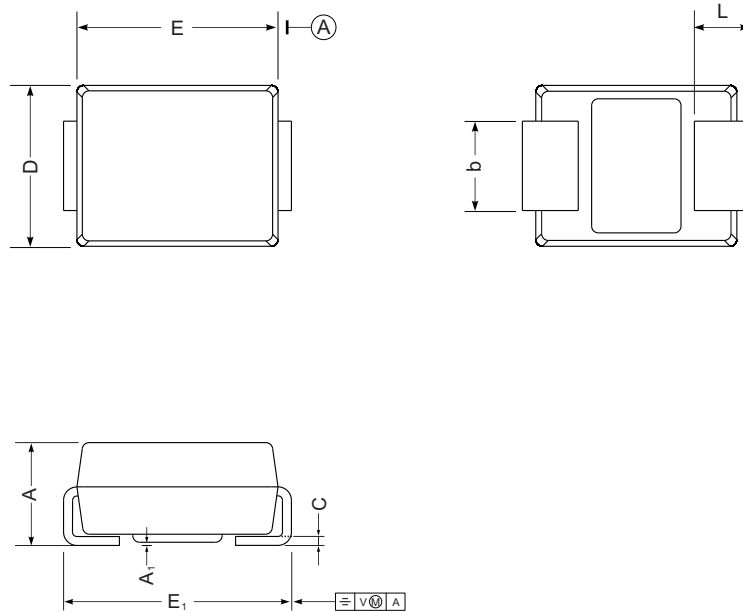

SMB mechanical data

| UNIT |     | A    | E    | D    | E <sub>1</sub> | A <sub>1</sub> | L   | C     | b    |
|------|-----|------|------|------|----------------|----------------|-----|-------|------|
| mm   | max | 2.44 | 4.70 | 3.94 | 5.59           | 0.20           | 1.5 | 0.305 | 2.11 |
|      | min | 2.13 | 4.06 | 3.3  | 5.08           | 0.05           | 0.8 | 0.152 | 1.91 |
| mil  | max | 96   | 185  | 155  | 220            | 7.9            | 59  | 12    | 83   |
|      | min | 84   | 160  | 130  | 200            | 2.0            | 32  | 6     | 75   |

### The recommended mounting pad size

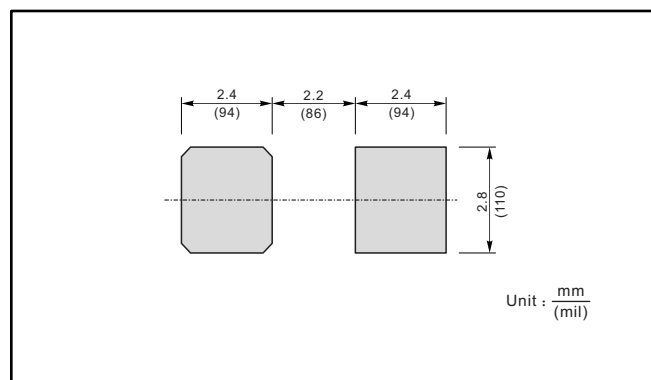

## X-ON Electronics

Largest Supplier of Electrical and Electronic Components

*Click to view similar products for [ESD Suppressors / TVS Diodes](#) category:*

*Click to view products by [Juxing Electronic Technology](#) manufacturer:*

Other Similar products are found below :

[60KS200C](#) [D18V0L1B2LP-7B](#) [D5V0F4U5P5-7](#) [NTE4902](#) [P4KE27CA](#) [P6KE11CA](#) [P6KE8.2A](#) [SA60CA](#) [SA64CA](#) [SMBJ12CATR](#)  
[SMBJ33CATR](#) [SMBJ6.5A](#) [SMBJ8.0A](#) [ESD101-B1-02ELS E6327](#) [ESD112-B1-02EL E6327](#) [ESD7451N2T5G](#) [19180-510](#) [CPDT-5V0USP-](#)  
[HF](#) [3.0SMCJ33CA-F](#) [3.0SMCJ36A-F](#) [HSPC16701B02TP](#) [JANTX1N6126A](#) [D3V3Q1B2DLP3-7](#) [D55V0M1B2WS-7](#) [SCM1293A-04SO](#)  
[ESD200-B1-CSP0201 E6327](#) [SM12-7](#) [CEN955 W/DATA](#) [VESD12A1A-HD1-GS08](#) [CPDQC5V0-HF](#) [D1213A-01LP4-7B](#) [ESD101-B1-02EL](#)  
[E6327](#) [AOZ8808DI-03](#) [5KP15A](#) [5KP48A](#) [5KP90A](#) [ESD3V3D7-TP](#) [15KPA36A-LF](#) [P4KE56CA](#) [P4KE68A](#) [P4KE91CATR](#) [P6KE120A](#)  
[P6KE13CA](#) [P6KE43CA](#) [P6KE6.8CA](#) [P6KE8.2](#) [P6SMBJ20CA](#) [JANTX1N6072A](#) [SR2835ESKG](#) [SA90CA](#)