



MIANYANGGAOXINDISTRICTJING WEIDASCIENCE & TECHNOLOGYCO.,LTD

10/100/1000Base T Single Port Transformer Module

Part Number:SG24002 G

Page:1/2

- Designed to meet IEEE 802.3ab and IEEE803.3u requirement
- Lead-Free & Designed to meet RoHS requirement
- Primary inductance 350uH min.with 8mA DC Bias
- Single Port for NIC Application

Electrical Specifications @ 25°C

Part Number	Turns Ratio (±5%)		OCL(uH Min) @100KHz/0.1V with 8.0mA DC	Insertion Loss (dB Max) 1-100MHz	HI-POT (Vrms) 1500
	TX	RX			
SG24002 G	1CT:1CT	1CT:1CT	350	-1.0	1500

Continue

Part Number	Return Loss (dB Min)					Cross Talk (dB Min)			DCMR (dB Min)		
	1-30MHz	40MHz	50MHz	60-80MHz	100MHz	30MHz	60MHz	80MHz	30MHz	60MHz	100MHz
SG24002 G	-18	-14.4	-13.1	-12	-10	-45	-40	-35	-43	-37	-33

- Operating temperature range :-0°C to +70°C. Storage temperature range: -0°C to +85°C.

SCHEMATICS:

Mechanicals:

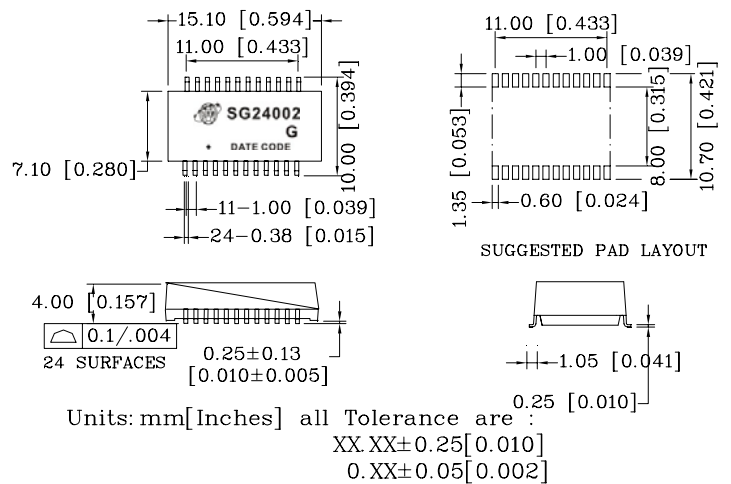
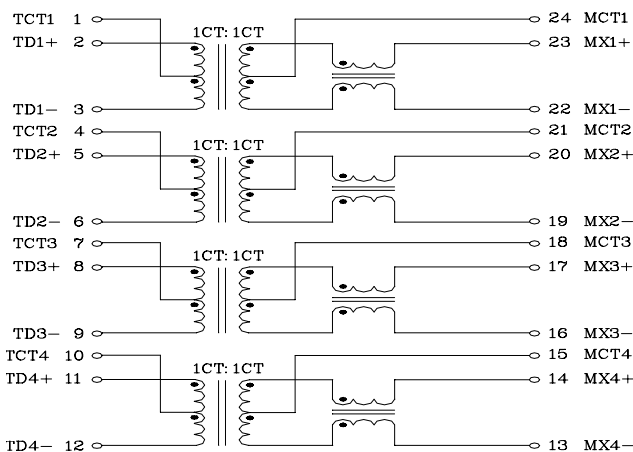



10/100/1000Base T Single Port Transformer Module

Part Number:SG24002 G

Page:2/2

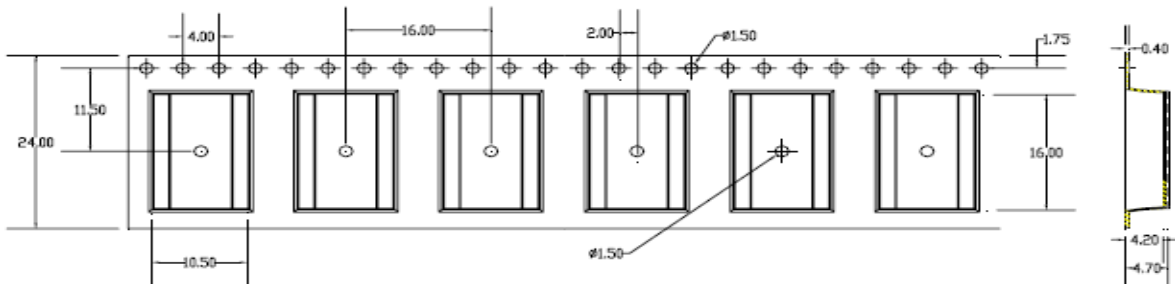

始端须预留 160mmMin(10PCS 空格)

末端须预留 390mm (27PCS 空格) Min-560mm(35PCS 空格) Max



Units:mm Tolerances+0.10

REELMECHANICALDIMENSION

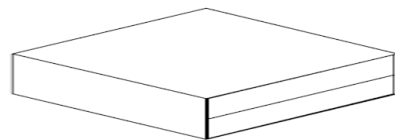
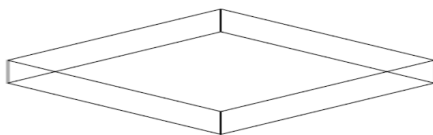

INNER CARTON:35(L)*35(W)*11.5(H)

EXPORT CARTON:36(L)*36(W)*26(H)

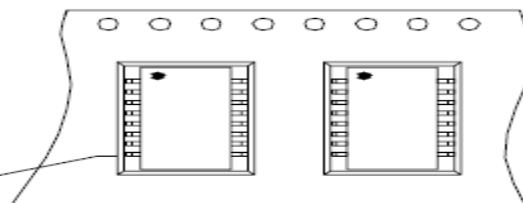
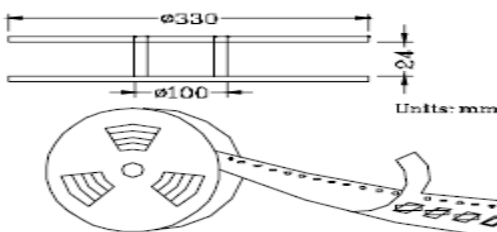

依次放入 800PCS 后终端预留长度后剪断胶格带，然后把盖带多绕一圈，再以胶带固定。

- 1、 ONE ROLL: 800PCS
- 2、 THREE ROLL BOX: 2400PCS
- 3、 TEO BOX CARTON: 4800PCS

Tel:+86-816-2562292/2561202

E-mail:jwdmy86@126.com

Fax:+86-816-2562916

Website: www.myjwd.com

X-ON Electronics

Largest Supplier of Electrical and Electronic Components

Click to view similar products for [Audio Transformers](#) / [Signal Transformers](#) category:

Click to view products by [JWD](#) manufacturer:

Other Similar products are found below :

[CU4S0506AT-2655-H1](#) [CX2041NLT](#) [MGPWT-00449-P](#) [PE-64961](#) [H1302FNLT](#) [H5004ENLT](#) [H5008FNL](#) [H5012FNL](#) [H5020FNLT](#)
[H5077NLT](#) [H5079NLT](#) [H5084FNLT](#) [1812WBT2-4](#) [1879479-1](#) [HX2260FNL](#) [PA1528ANL](#) [EX2024FNL](#) [T1137NLT](#) [T3012NL](#) [PE-](#)
[65812FNL](#) [PE-65848FNLT](#) [H1174FNL](#) [H1302FNL](#) [H5015FNL](#) [H5019EFNL](#) [H5062FNLT](#) [CX2047LNL](#) [MET-14](#) [MGPWT-00059-P](#)
[MGPWT-00266-P](#) [MGPWT-00278-P](#) [MGPWT-00431-P](#) [TTC-100](#) [TTC-143-H](#) [BX1194WNLT](#) [HX1234NLT](#) [HX5008FNLT](#) [HX5019FNL](#)
[HX5084NL](#) [3-1879385-5](#) [TX1263NLT](#) [4-1879391-0](#) [100213](#) [T1142NL](#) [HX6101FNL](#) [HX5084FNL](#) [HX1148NL](#) [HX5020FNLT](#)
[HX5014FNLT](#) [T1124NL](#)