

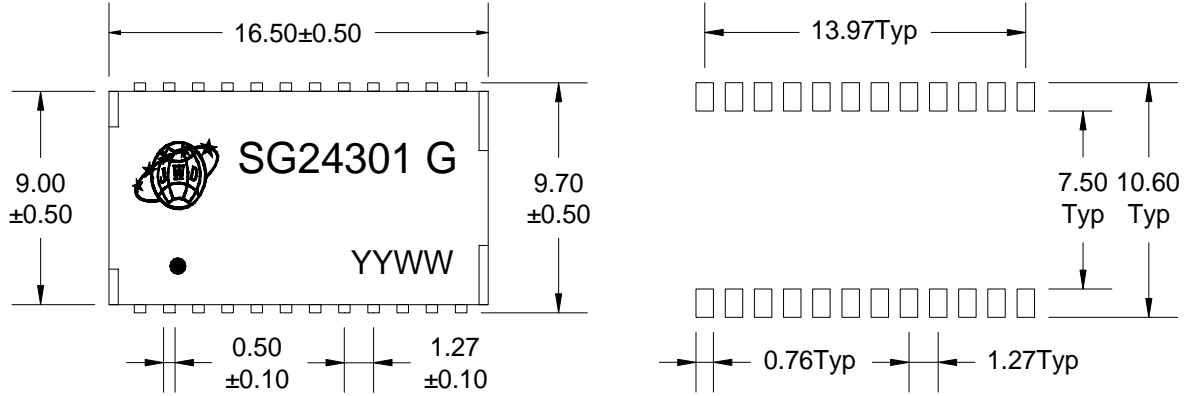

# 绵阳高新区经纬达科技有限公司

Mianyang Highly-Tech Jingweida Scientific Co., Ltd

## A. MECHANICAL(unit:mm)



### SUGGESTED PAD LAYOUT

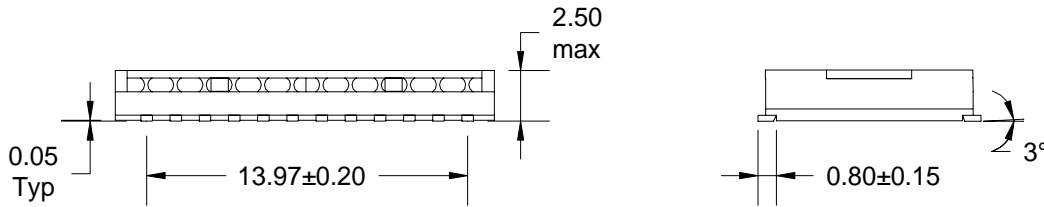

## B. SCHEMATICS

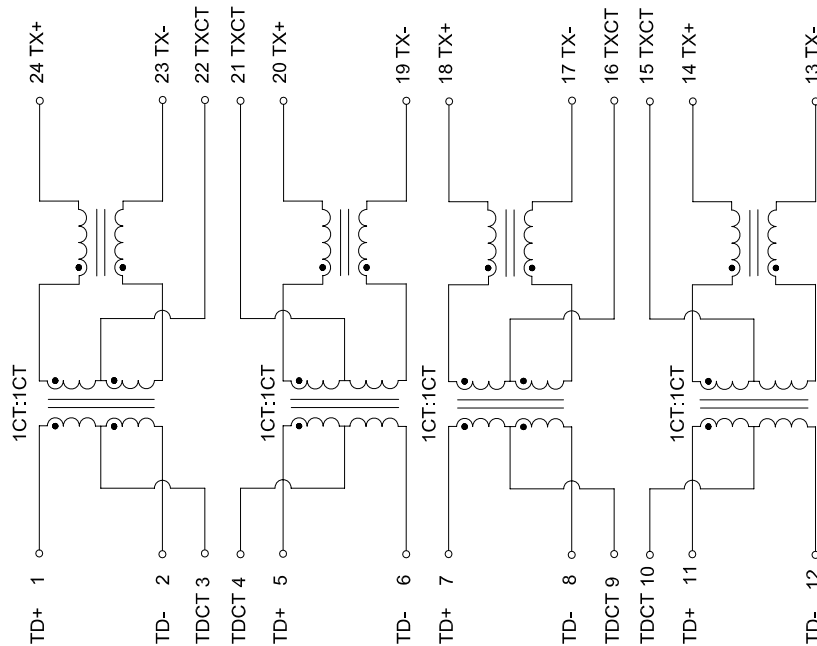

DESCRIPTION	JWD P/N	SPEC NO	REV: R0
100/1000 BASE-T	SG24301 G		PAGE: 1/3



# 绵阳高新区经纬达科技有限公司

Mianyang Highly-Tech Jingweida Scientific Co., Ltd

## C. ELECTRICAL SPECIFICATIONS @25°C

1. OCL: 350uH Min @ 100KHz, 0.1V
2. Leakage Inductance: 0.5uH Max @ 100KHz, 0.1V
3. DCR: 1400mΩ Max
4. Turns Ratio: 1CT:1CT±5%
5. Insertion Loss: -1.1 dB Max @ 1-100 MHz
6. Return Loss: -18 dB Min @ 1-30 MHz
  - 14.4 dB Min @40 MHz
  - 13.1 dB Min @ 50 MHz
  - 12 dB Min @ 60-80 MHz
  - 10 dB Min @ 100 MHz
7. Cross Talk: -30 dB Min @ 1-100 MHz
8. Common Mode Rejection: -30 dB Min @ 1-100 MHz
9. Isolation Hipot: 1500VAC 1mA 60S
10. Operating temperature 0°C to +70°C
11. Storage temperature -25°C to +125°C

DESCRIPTION	JWD P/N	SPEC NO	REV: R0
100/1000 BASE-T	SG24301 G		PAGE: 2/3



# 绵阳高新区经纬达科技有限公司

Mianyang Highly-Tech Jingweida Scientific Co., Ltd

## D. PACKAGE INFORMATION

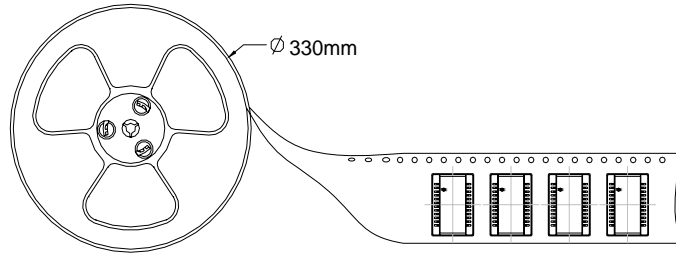
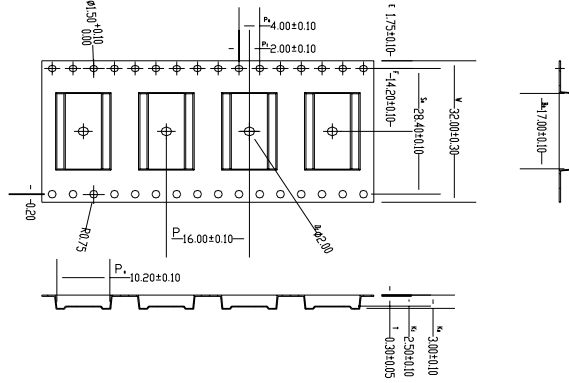

备注: 每卷载带前空14格,后空12格 (靠近卷轴端为前)

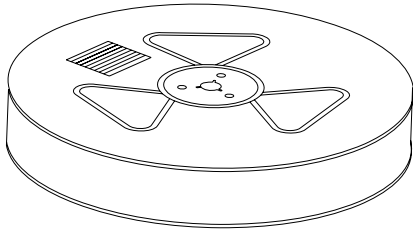

two reel

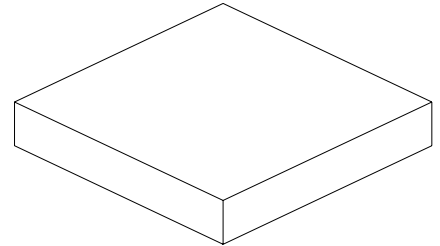

Inner Carton

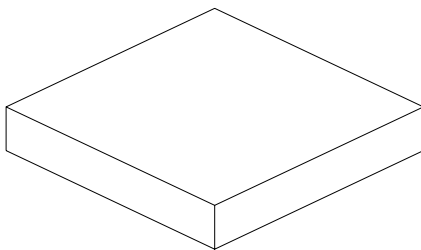

two Inner Carton

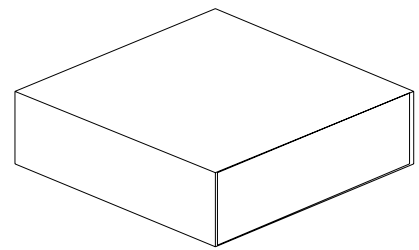

Export Carton

Package Quantity:

One Reel=1500Pcs

One Inner Carton=1500\*2=3000Pcs

One Export Carton=3000\*2=6000Pcs

DESCRIPTION	JWD P/N	SPEC NO	REV: R0
100/1000 BASE-T	SG24301 G		PAGE: 3/3

## X-ON Electronics

Largest Supplier of Electrical and Electronic Components

*Click to view similar products for [Audio Transformers](#) / [Signal Transformers](#) category:*

*Click to view products by [JWD](#) manufacturer:*

Other Similar products are found below :

[CU4S0506AT-2655-H1](#) [CX2041NLT](#) [MGPWT-00449-P](#) [PE-64961](#) [H1302FNLT](#) [H5008FNL](#) [H5012FNL](#) [H5020FNLT](#) [H5077NLT](#)  
[H5079NLT](#) [H5084FNLT](#) [1812WBT2-4](#) [1879479-1](#) [HX2260FNL](#) [PA1528ANL](#) [EX2024FNL](#) [T1137NLT](#) [T3012NL](#) [PE-65812FNL](#) [PE-65848FNLT](#) [H1174FNL](#) [H1302FNL](#) [H5015FNL](#) [H5019EFNL](#) [H5062FNLT](#) [CX2047LNL](#) [MET-14](#) [MGPWT-00059-P](#) [MGPWT-00266-P](#)  
[MGPWT-00278-P](#) [MGPWT-00431-P](#) [TTC-100](#) [TTC-143-H](#) [BX1194WNLT](#) [HX1234NLT](#) [HX5008FNLT](#) [HX5019FNL](#) [HX5084NL](#) [3-1879385-5](#) [TX1263NLT](#) [4-1879391-0](#) [100213](#) [T1142NL](#) [HX6101FNL](#) [HX5084FNL](#) [HX1148NL](#) [HX5020FNLT](#) [HX5014FNLT](#) [T1124NL](#)  
[1879732-1](#)