

CRYSTAL RESONATOR SPECIFICATIONS

石英晶体谐振器承认书

客户 Customer:	立创商城
型号 Product:	3TJ4
客户料号 Code No:	
我司料号 Code No:	3TJ413573ZYGBC
频率 Frequency:	13.5732MHz
数量 Sample Quantity:	
日期 Date:	2023-5-10

深圳市晶友嘉电子有限公司

SHENZHEN JINGYOUJIA ELECTRONIC CO., LTD
深圳市龙华区东环二路数字颖博智能园 B 栋 412

TEL: 86-755-32840201 32850080
FAX: 86-755-84269460

供应商确认栏:

制作 Handler	确认 Checked	核审 Approved
戴晓嘉	陈斌	李晨

客户承认栏:

承认 Checked	核审 Approved

1. Electrical Parameters

No.	Item	Symb	Electrical Specification				Remark
			Min.	Type	Max.	Units	
1	Nominal Frequency	F0	13.5732			MHz	
2	Mode of Vibration		Fundamental				
3	Frequency Tolerance	$\Delta F/F0$	-10		10	ppm	At 25°C ± 3°C
4	Operating Temperature Range	TOPR	-30		85	°C	
5	Frequency Stability	TC	-20		20	ppm	
6	Storage Temperature	TSTG	-40		90	°C	
7	Load Capacitance	CL	20			PF	
8	Equivalent Series Resistance	ESR			70	Ω	
9	Drive Level	DL	100			μW	
10	Insulation Resistance	IR	500			M Ω	At 100VDC
11	Shunt Capacitance	C0			5	PF	
12	Motional Capacitance	C1				PF	
13	Aging Per Year	Fa	-3		3	ppm	First Year

2. Equivalent Circuit:

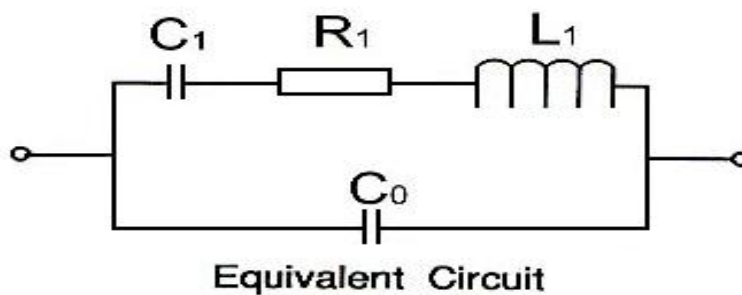

3.实物 Product

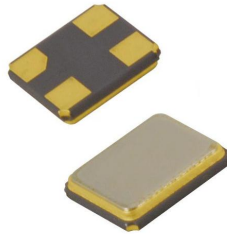

4.外型尺寸 Outline Dimensions (unit:mm)

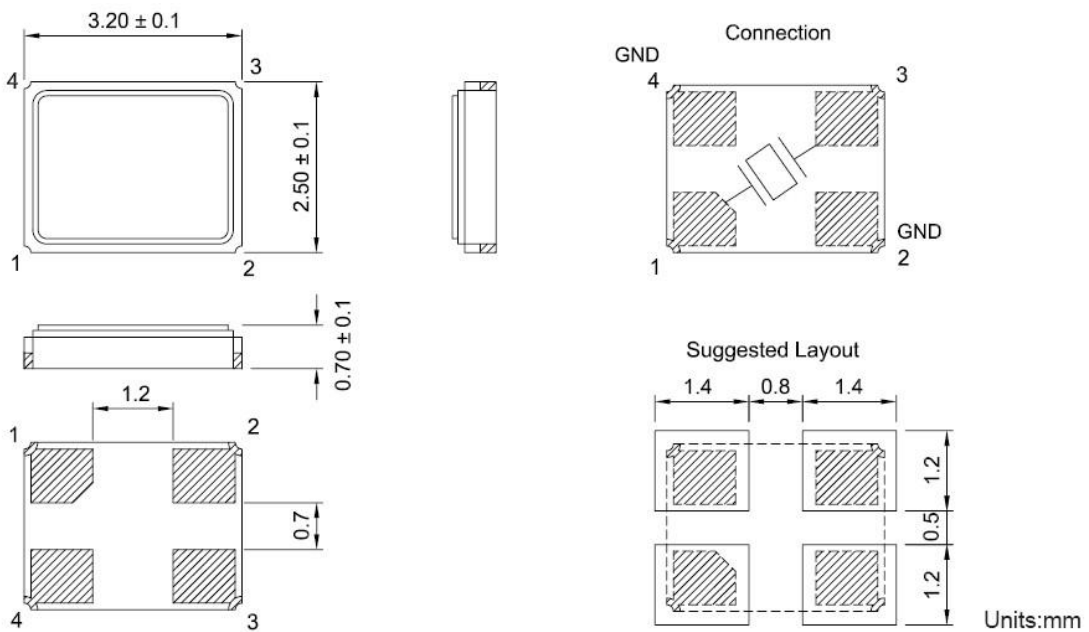

5.回流焊曲线 Reflow Profiles

Profiles Feature	Pb-Free Assembly
Average Ramp-up Rate (Ts max to Tp)	3°C/second max.
Preheat	
Temperature Min (Ts min)	125°C
Temperature Max(Ts max)	200°C
Time (ts min to ts max)	60~180 seconds
Time maintained above	
Temperature (TL)	217°C
Time (tL)	60~150 seconds
Peak/Classification Temperature (Tp)	
Time within 5°C of actual Peak	20~40 second
Temperature(tp)	
Ramp-down rate	6°C/second max.
Time 25°C to Peak Temperature	8 minutes max.
Suggest reflow times	3 times max.

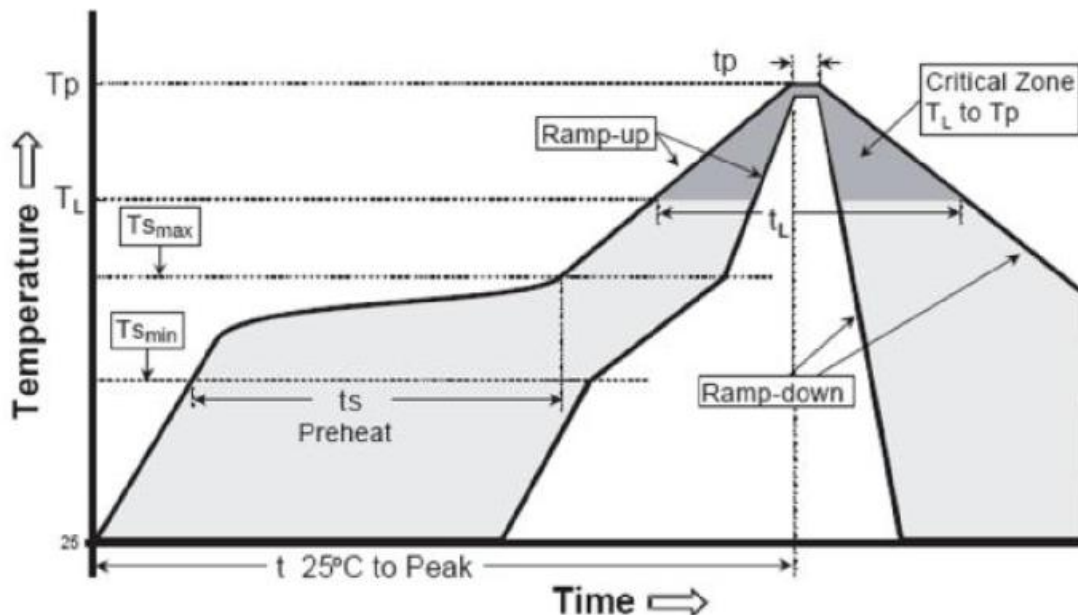



6.机械可靠/信赖性 Mechanical Performance

	Item	Condition	Standard
1.	Drop characteristics	Free drop from 50cm height on a hard wooden board for 3 times. (Board is thickness more than 30 mm.)	Frequency change: ≤5ppm Rr as specification
2..	Shake characteristics	Shake frequency 10~55Hz, cyc1~2 minutes, swing 1.5mm, direction x/y/z, all 30 minutes, test after 1 hours.	Frequency change: ≤5ppm Rr as specification
3.	Airproof characteristics	Put crystal into the pressure cabin with alcohol, keep pressure 0.4~0.5mpa 10 minutes, then take out and blow for 5 minutes	IR≥500MΩ
4.	Weld characteristics	260℃ Max, 10 seconds	90% exhibit tin ok
5.	Humidity characteristics	+40±2℃ & 90%~95% R.H. 250 hours	Frequency change: ≤5ppm Rr as specification
6.	Low temperature characteristics	-30±2℃, 250 hours, put in room temperature, test after 1 hours.	Frequency change: ≤5ppm Rr as specification
7.	High temperature characteristics	+85±2℃, 250 hours, put in room temperature, test after 1 hours.	Frequency change: ≤5ppm Rr as specification
8.	Temperature cycling	-30±3℃/30±3 min~+85±2℃/30±3min, 5 cycles	Frequency change: ≤5ppm Rr as specification

7.Dimension of Inside Package

内包装尺寸图

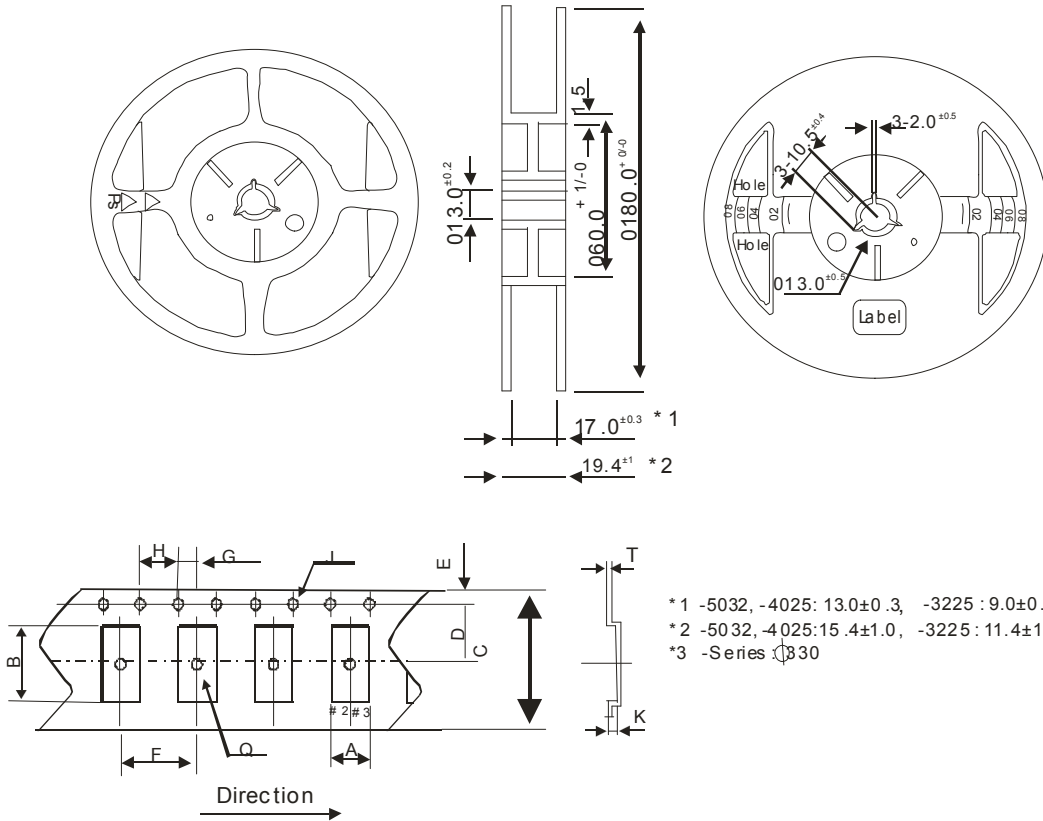

- Standard quantity of 3225 : 3.000 pcs/reel
- Standard quantity of others : 1.000 pcs/reel
- Carrier tape : Antistatic material (PS)
- Each reel can be recycled

	7050	6035	5032	3225
A	5.4 ^{±0.1}	3.9 ^{±0.1}	3.5 ^{±0.1}	2.9 ^{±0.1}
B	7.4 ^{±0.1}	6.4 ^{±0.1}	5.4 ^{±0.1}	3.6 ^{±0.1}
C	16.0 ^{±0.2}	16.0 ^{±0.2}	12.0 ^{±0.2}	10.0 ^{±0.2}
D	7.5 ^{±0.1}	7.5 ^{±0.1}	5.5 ^{±0.1}	5.5 ^{±0.1}
E	1.75 ^{±0.1}	1.75 ^{±0.1}	1.75 ^{±0.1}	1.75 ^{±0.1}
F	8.0 ^{±0.1}	8.0 ^{±0.1}	8.0 ^{±0.1}	4.0 ^{±0.1}
G	2.0 ^{±0.1}	2.0 ^{±0.1}	2.0 ^{±0.1}	2.0 ^{±0.1}
H	4.0 ^{±0.1}	4.0 ^{±0.1}	4.0 ^{±0.1}	4.0 ^{±0.1}
J	1.55 ^{±0.05}	1.55 ^{±0.05}	1.5 ^{+0.1/0}	1.5 ^{±0.1/0}
K	1.4 ^{±0.1}	1.5 ^{±0.1}	1.0 ^{±0.1}	0.9 ^{±0.1}
Q	1.6 ^{+0.1/0}	1.55 ^{±0.05}	1.6 ^{±0.1}	1.5 ^{±0.1/0}
T	0.3 ^{±0.05}	0.3 ^{±0.05}	0.25 ^{±0.05}	0.25 ^{±0.05s}

8. Inner carton

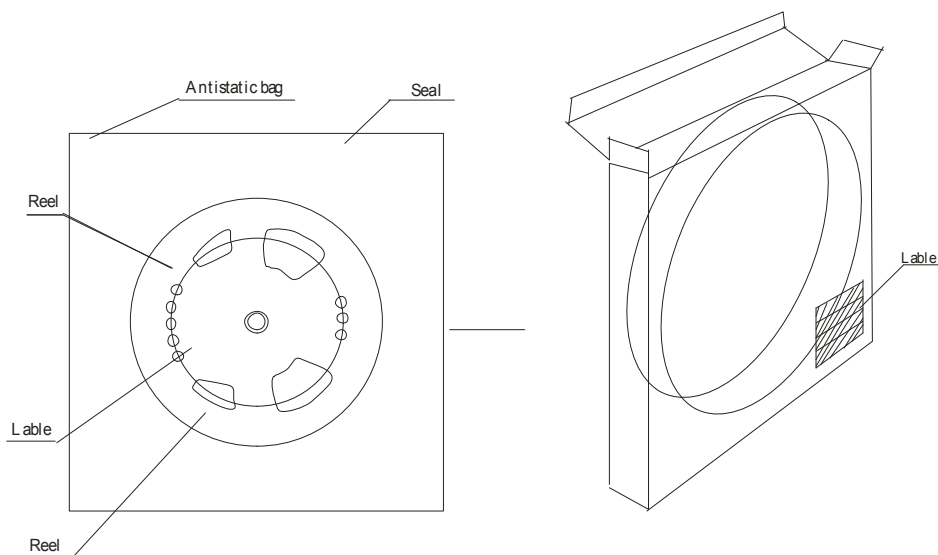

OUTET CARTON

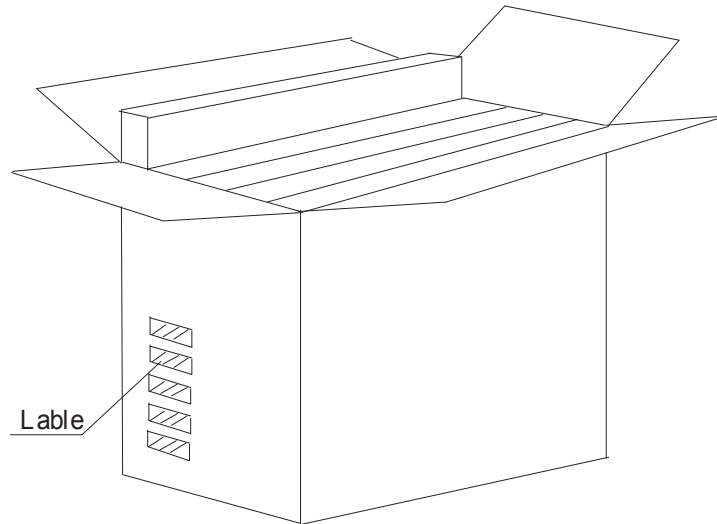

8-1. MARKING

- (1) Marking Labels are affixed to reel, inner carton and outer carton.
- (2) Each label contains the following information.
 - (a) Manufacture's name or aymbol
 - (b) Parts name or type
 - (c) Frequency
 - (d) Quantity
 - (e) Reel number
 - (f) Manufacturer's code (EIAJ code)

8-2. QUANTITY

3000pcs/reel (max.5reels in outer carton)

8-3. STORAGE ENVIRONMENT

- ✧ Storage the reel at normal temperature and humidity
- ✧ Open the packing just before using
- ✧ Do not expose the sun
- ✧ Do not storage with some erosive chemicals
- ✧ Nothing is allowed to put on the reel or carton to prevent mechanical damage
- ✧ Nothing is allowed to put on the reel or carton to prevent mechanical damage.

8-4. HANDLING

- ✧ Handle with care to prevent the damage of tape, reel and products.

X-ON Electronics

Largest Supplier of Electrical and Electronic Components

Click to view similar products for [Crystals](#) category:

Click to view products by [JYJE](#) manufacturer:

Other Similar products are found below :

[CX3225GB25000M0PPSZ1](#) [718-13.2-1](#) [7A-40.000MAAE-T](#) [FL2000085](#) [99-BU](#) [9B-15.360MBBK-B](#) [9C-7.680MBBK-T](#) [H10S-12.000-18-EXT-TR](#) [ABC2-6.000MHZ-D4Z-T](#) [ABLS-20.000MHZ-D2-T](#) [ABS071-32.768KHZ-6-T](#) [R38-32.768-12.5-5PPM-NPB](#) [BTD1062E05A-513](#) [21U15A-21.4MHZ](#) [RTX-781DF1-S-20.950](#) [LFXTAL066198Cutt](#) [9C-14.31818MBBK-T](#) [A-11.000MHZ-27](#) [ABL-27.000MHZ-B4Y-T](#) [ABM11-132-24.000MHZ-T3](#) [ABM3B1-25.000MHZ-D2Y-T](#) [SPT2A-.032768B](#) [SPT2A.032768G](#) [SSPT7F-9PF20-R](#) [LFXTAL065253Cutt](#) [LFXTAL066431Cutt](#) [XT9S20ANA14M7456](#) [XT9SNLANA16M](#) [7A-24.576MBBK-T](#) [7B-30.000MBBK-T](#) [MMCC2R32.7680KHZ](#) [7A-14.31818MBBK-T](#) [6504-202-1501](#) [6526-202-1501](#) [ABLS-12.000MHZ-B2Y-T](#) [7A-10.000MBBK-T](#) [SG636PCE-20.000MC](#) [3404](#) [E1SAA18-25.000M TR](#) [CM315D32768EZFT](#) [C1E-24.000-7-2020-R](#) [C1E-19.200-12-1530-X-R](#) [C1E-16.000-12-1530-X-R](#) [ABM11-16.000MHZ-9-B1U-T](#) [FL5000014](#) [EUCA18-3.1872M](#) [FX0800015](#) [425F35E027M0000](#) [FP0800018](#) [MS3V-T1R-32.768kHz-7pF-20PPM-TA-QC-Au](#)