

REV	ECN	CONTENT	CHECK	DATE
V0.0		初版发行	YZG	2017.03.12
V1.0		整理图纸	WL	2019.09.25

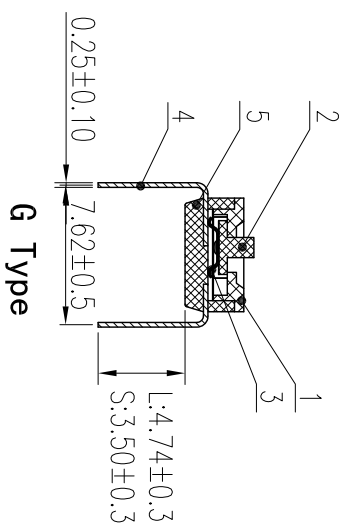

- 技术要求:
- 额定电流: 25mA, 24VDC (开与关切换时) 100mA, 50VDC (开与关不切换时)
 - 接触阻抗: $\leq 50m\Omega$ (初始), $\leq 100m\Omega$ (寿命测试后)
 - 绝缘电阻: $\geq 100M\Omega / 500VDC$
 - 耐电压: 500VAC/1minute
 - 拨动力: 1000g max
 - 拨动行程: 0.9mm
 - 机械寿命: ≥ 2000 cycles
 - 电气寿命: ≥ 2000 cycles/25mA, 24VDC
 - 使用温度: $-40^\circ C \sim +85^\circ C$
 - 存储温度: $-40^\circ C \sim +85^\circ C$
 - 符合RoHS要求

焊接说明:
 波峰焊接: 250 ±10°C, 5S max
 手工焊接: 30W电烙铁, 320 ±5°C, 3S max
 焊接前保持开关在“OFF”状态

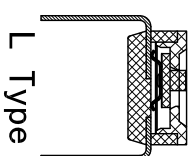
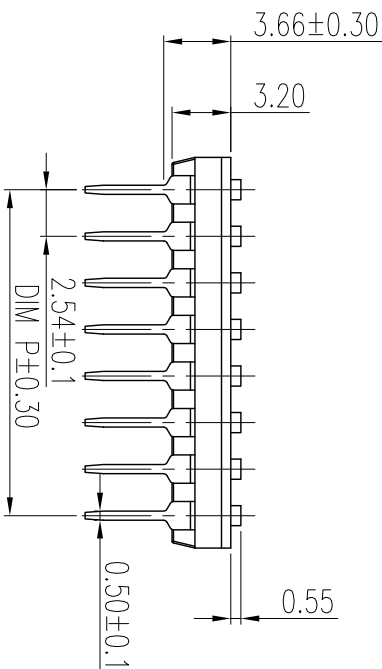
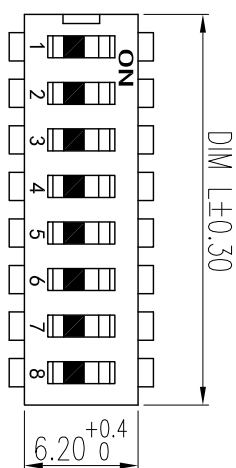
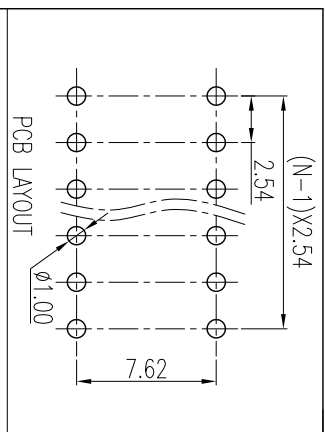
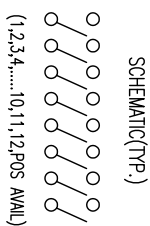
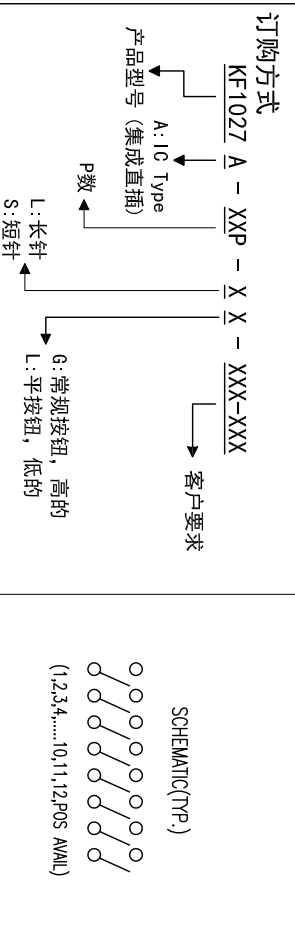

General tolerance in mm

over	0	3	6	30	120	400	400	1000	over	0.5	3	6	10	10	50	120	100	100	150
to	3	6	30	120	400	1000	400	1000	to	0.5	3	6	10	10	50	120	100	100	150
±0.15	±0.2	±0.25	±0.3	±0.5	±0.8	±0.2	±0.5	±1.0	±1°	±30'	±20'	0.5	0.2	0.3	0.5				

订购方式

KF1027 A - XXP - X X - XXX-XXX

客户要求

产品型号 (集成直插)

A: IC Type

P数

L: 长针

S: 短针

G: 常规按钮, 高的

L: 平按钮, 低的

Poles	Dim P	Dim L	底座	弹片	拨柄	盖板	APP.	CHK.	DWG.	UNITS	MM	SCALE	SHEET	PROJECTION-METHOD
1P	---	3.54	5	4	3	1	APP.	CHK.	DWG.	UNITS	MM	SCALE	SHEET	PROJECTION-METHOD
2P	2.54	6.08	2P	2P	P	1	2019.9.25	2019.9.25	2019.9.25	MM	1:1	1/1		
3P	5.08	8.62	3P	3P	P	1	2019.9.25	2019.9.25	2019.9.25	MM	1:1	1/1		
4P	7.62	11.16	4P	4P	P	1	2019.9.25	2019.9.25	2019.9.25	MM	1:1	1/1		
5P	10.16	13.70	5P	5P	P	1	2019.9.25	2019.9.25	2019.9.25	MM	1:1	1/1		
6P	12.70	16.24	6P	6P	P	1	2019.9.25	2019.9.25	2019.9.25	MM	1:1	1/1		
7P	15.24	18.78	7P	7P	P	1	2019.9.25	2019.9.25	2019.9.25	MM	1:1	1/1		
8P	17.78	21.32	8P	8P	P	1	2019.9.25	2019.9.25	2019.9.25	MM	1:1	1/1		
9P	20.32	23.86	9P	9P	P	1	2019.9.25	2019.9.25	2019.9.25	MM	1:1	1/1		
10P	22.86	26.40	10P	10P	P	1	2019.9.25	2019.9.25	2019.9.25	MM	1:1	1/1		
11P	25.40	28.94	11P	11P	P	1	2019.9.25	2019.9.25	2019.9.25	MM	1:1	1/1		
12P	27.94	31.48	12P	12P	P	1	2019.9.25	2019.9.25	2019.9.25	MM	1:1	1/1		

DF 慈溪市凯峰电子有限公司
 CIXI KAIFENG ELECTRONICS CO., LTD

X-ON Electronics

Largest Supplier of Electrical and Electronic Components

Click to view similar products for [DIP Switches/SIP Switches](#) category:

Click to view products by [KAIFENG](#) manufacturer:

Other Similar products are found below :

[79B10T](#) [8136-475G4T](#) [G7G-1A2-CB-DC12](#) [DRS4016](#) [1825444-1](#) [193005MS](#) [195010MS](#) [200183](#) [206002](#) [208004](#) [208007ST](#) [208008](#)
[25.350.0653.0](#) [SDA10H1BDA](#) [97R06ST](#) [A2C-2A5](#) [1825444-7](#) [ADE12S04](#) [206005RAS](#) [206007](#) [209005LPST](#) [2-1825058-8](#) [219002LPST](#)
[219002MSTJRF](#) [219012MST](#) [25.352.0353.0](#) [CXDRIVEV2X](#) [LA2-002-DC24](#) [DSR02T](#) [193004MS](#) [E2FMX2D1M1TGJ03M](#) [NDI10H](#) [219-](#)
[9MSTP](#) [219008LPSTR](#) [EPM02FV](#) [206010RAST](#) [76SB05](#) [TD06H0SK1](#) [Z7.255.9027.0](#) [1-1825058-3](#) [1825428-4](#) [219-10LPSTF](#)
[E3ZG6111D03M](#) [G4D212PUSTV2DC5](#) [HARW0002](#) [EPG301BT06](#) [1-1825058-6](#) [E3TSL23M5J03M](#) [Y5795](#) [7R0060](#)