

## Positive Temperature Coefficient (PTC) Data Sheet

### Features

- Radial leaded devices.
- Over-current protection
- High voltage surge capabilities
- Flame retardant epoxy polymer insulating material meets UL94 V-0 requirement.
- Available in lead-free version.
- Meets MSL level 1, per J-STD-020
- Operating Temperature: -40°C~+85°C

### Applications

- IT equipment
- Access network equipment
- Central office equipment
- ISDN and xDSL equipments
- Phone set and fax machine
- LAN/WAN and VOIP cards

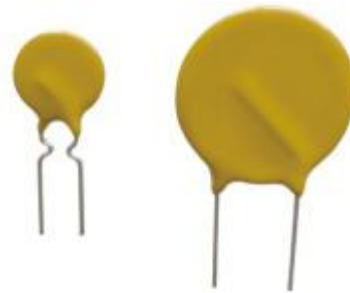

### Part Number Code and Making

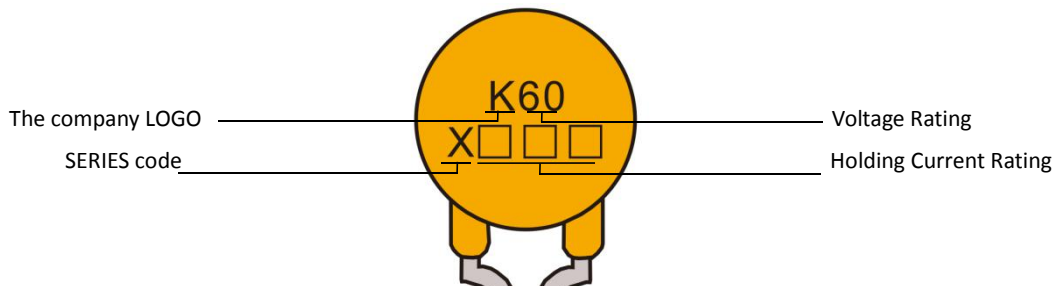
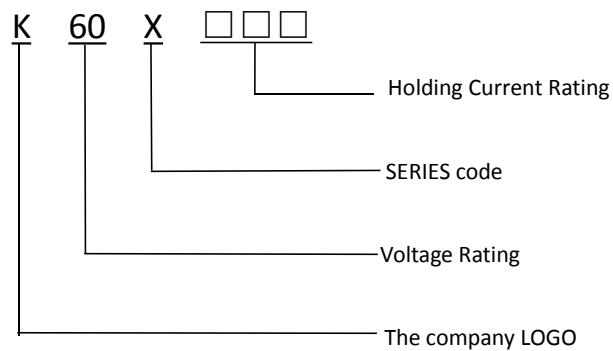

**Dimensions (Unit: mm)**

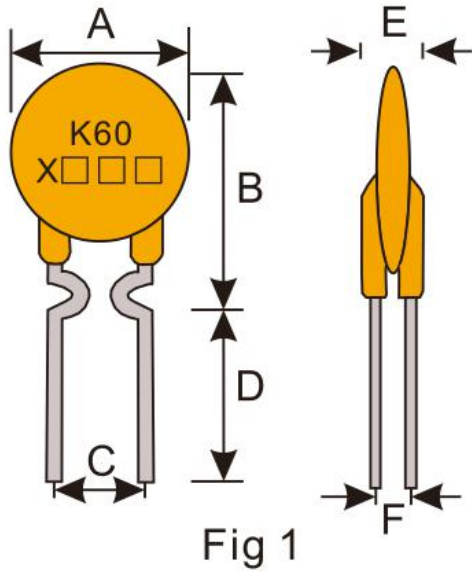

Fig 1

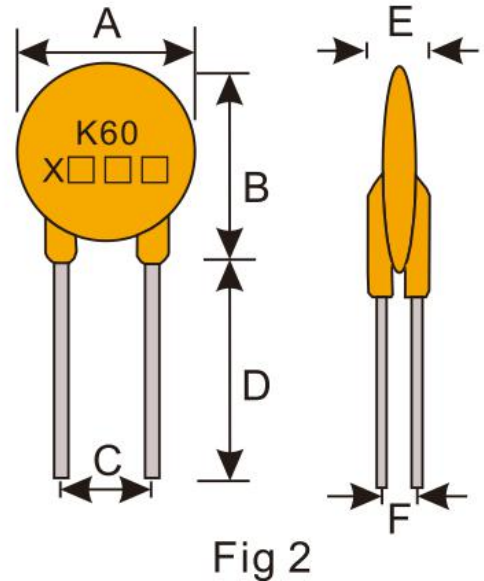

Fig 2

Part Number	Style	A	B	C	D	E	F	leda
		MAX	MAX	Typ	MIN	MAX	Typ	Φ
KX60-003	1	7.4	13.0	5.1	7.6	3.1	0.9	0.50CP
KX60-005	1	7.4	13.0	5.1	7.6	3.1	0.9	0.50CP
KX60-010	1	7.4	13.0	5.1	7.6	3.1	0.9	0.50CP
KX60-017	1	7.4	13.0	5.1	7.6	3.1	0.9	0.50CP
KX60-017R	1	7.4	13.0	5.1	7.6	3.5	0.9	0.50CP
KX60-020	1	7.4	13.0	5.1	7.6	3.1	0.9	0.50CP
KX60-025	1	7.4	13.0	5.1	7.6	3.1	0.9	0.50CP
KX60-030	1	7.4	13.0	5.1	7.6	3.1	0.9	0.50CP
KX60-040	1	7.6	13.5	5.1	7.6	3.1	0.9	0.50CP
KX60-050	1	7.9	13.7	5.1	7.6	3.1	0.9	0.50CP
KX60-065	1	9.4	17.0	5.1	7.6	3.1	1.0	0.60CP
KX60-075	1	10.2	17.0	5.1	7.6	3.1	1.0	0.60CP
KX60-090	1	11.2	17.0	5.1	7.6	3.1	1.0	0.60CP
KX60-110	2	12.8	17.5	5.1	7.6	3.1	1.4	0.80CP
KX60-135	2	14.5	19.1	5.1	7.6	3.1	1.4	0.80CP
KX60-160	2	16.3	20.8	5.1	7.6	3.1	1.4	0.80CP
KX60-185	2	17.5	22.4	5.1	7.6	3.1	1.4	0.80CP
KX60-250	2	21.0	25.4	10.2	7.6	3.1	1.4	0.78 铜
KX60-300	2	24.5	28.6	10.2	7.6	3.1	1.4	0.78 铜
KX60-375	2	27.2	31.8	10.2	7.6	3.1	1.4	0.78 铜
KX60-500	2	27.2	31.8	10.2	7.6	3.1	1.4	0.78 铜

**Electrical Characteristics**

Part Number	Vmax	Imax	Ihold	Itrip	Pdmax	Max Time	Tirp	Resistance	
	(V)	(A)	(A)	(A)	(W)	(A)	(s)	Rmin(Ω)	R1max(Ω)
KX60-003	60	40	0.03	0.08	1.00	0.15	10.0	33.0	97.5
KX60-005	60	40	0.05	0.10	1.00	0.25	10.0	16.0	39.0
KX60-010	60	40	0.10	0.20	1.00	0.50	10.0	2.50	6.75
KX60-017	60	40	0.17	0.34	1.00	0.85	10.0	2.00	4.80
KX60-017R	60	40	0.17	0.34	1.00	0.85	10.0	3.30	7.82
KX60-020	60	40	0.20	0.40	1.00	1.00	10.0	1.50	4.26
KX60-025	60	40	0.25	0.50	1.00	1.25	10.0	1.00	2.93
KX60-030	60	40	0.30	0.60	1.00	1.50	10.0	0.76	2.04
KX60-040	60	40	0.40	0.80	1.00	2.00	10.0	0.52	1.29
KX60-050	60	40	0.50	1.00	1.00	2.50	10.0	0.41	1.16
KX60-065	60	40	0.65	1.30	1.00	3.25	10.0	0.27	0.72
KX60-075	60	40	0.75	1.50	1.00	3.75	10.0	0.18	0.60
KX60-090	60	40	0.90	1.80	1.00	4.50	10.0	0.14	0.465
KX60-110	60	40	1.10	2.20	1.51	5.50	10.0	0.14	0.375
KX60-135	60	40	1.35	2.70	1.71	6.75	10.0	0.12	0.285
KX60-160	60	40	1.60	3.20	1.98	8.00	11.4	0.09	0.210
KX60-185	60	40	1.85	3.70	2.10	9.25	12.6	0.08	0.180
KX60-250	60	40	2.50	5.00	2.50	12.50	15.6	0.05	0.120
KX60-300	60	40	3.00	6.00	2.80	15.00	19.8	0.04	0.090
KX60-375	60	40	3.75	7.50	3.20	18.75	24.0	0.03	0.075
KX60-500	60	40	5.00	10.0	3.20	20.00	30.0	0.012	0.045

**Parameter interpretation**

- IH = Hold current: maximum current device will pass without tripping in 25°C still air.
- IT = Trip current: minimum current at which the device will trip in 25°C still air.
- VMAX = Maximum voltage device can withstand without damage at rated current.
- IMAX = Maximum fault current device can withstand without damage at rated voltage.
- RMAX = Maximum resistance of device in initial (un-soldered) state.
- RMIN = Minimum resistance of device in initial (un-soldered) state.
- Pd typ. = Typical power dissipation from device when in the tripped state at 25°C still air.

**Polymeric PTC Selecting Guide**

■ Determine the following operating parameters for the circuits:

- Normal operating current ( $I_{hold}$ )
- Maximum interrupt current ( $I_{max}$ )
- Maximum circuit voltage ( $V_{max}$ )
- Normal operating temperature surrounding device (min°C/max°C)

■ Select the device from factor and dimension suitable for the application

- Compare the maximum rating for  $V_{max}$  and  $I_{max}$  of the PPTC device with the circuit in application and make sure the circuit's requirement does not exceed the device rating.
- Check that PPTC device's trip time (time-to-trip) will protect the circuit.
- Verify that the circuit operating temperature is within the PPTC device's normal operating temperature range.
- Verify that performance and suitability of the chosen PPTC device in the application.

## WARNING

### ■ Mechanical Stress

- PPTC devices will undergo a thermal expansion during fault condition. If PPTC devices are installed or placed in an application where the space between PPTC devices and the surrounding materials (e.g., covering materials, packaging materials, encapsulate materials and the like) is insufficient, it will cause an inhibiting effect upon the thermal expansion. Pressing, twisting, bending and other kinds of mechanical stress will also adversely affect the performance of the PPTC devices, and shall not be used or applied.

### ■ Chemical Pollutants

- Silicone-based oils, oils, solvents, gels, electrolytes, fuels, acids, and the like will adversely affect the properties of PPTC devices, and shall not be used or applied.

### ■ Electronic and Thermal Effect

- PPTC devices are secondary protection devices and are used solely for sporadic, accidental over-current or over-temperature error condition, and shall NOT be used if or when constant or repeated fault conditions (such fault conditions may be caused by, among others, incorrect pin-connection of a connector) or over-extensive trip events may occur.

- PPTC devices are different from fuses and, when a fault condition occurs, will go into high-resistance state and do not open circuit, in which case the voltage at such PPTC devices may reach a hazardous level.

- Operation over the maximum rating or other forms of improper use may cause failure, arcing, flame and/or other damage to the PPTC devices.

- Conductive material contamination, such as metal particle, may induce shortage, flame or arcing.

- Due to the inductance, the operation circuits may generate a circuit voltage ( $Ldi/dt$ ) above the rated voltage of PPTC devices, which shall not be used under such circumstances.

### ■ General

- Customers shall evaluate and test the properties of PPTC devices independently to verify and ensure that their individual applications will be met.

- The performance of PPTC devices will be adversely affected if they are improperly used under electronic, thermal and/or mechanical procedures and/or conditions non-conformant to those recommended by manufacturer.

- Customers shall be responsible for determining whether it is necessary to have back-up, failsafe and/or fool-proof protection To avoid or minimize damage that may result from extra-ordinary, irregular function or failure of PPTC devices.

- Any and all responsibilities and liabilities are disclaimed if any item under this notice of warning is not complied with.

### Thermal Derating Curve

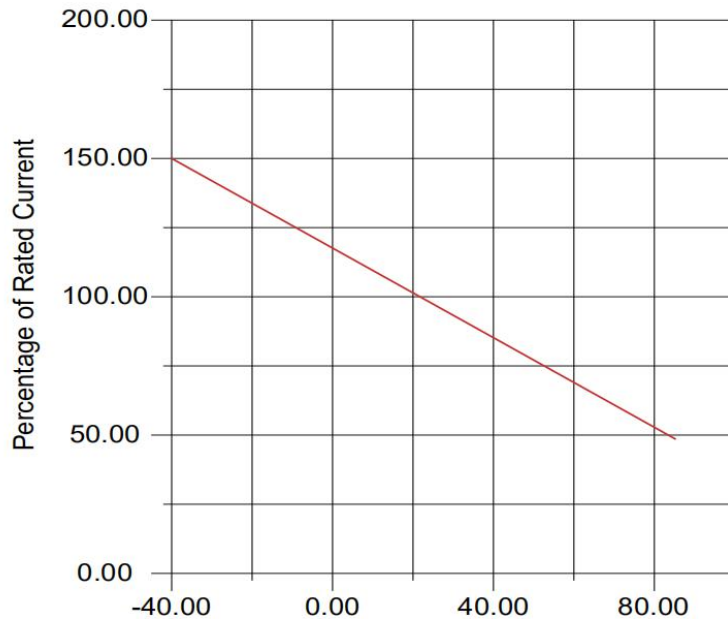

### Typical Time-To-Trip at 25°C ±2°C

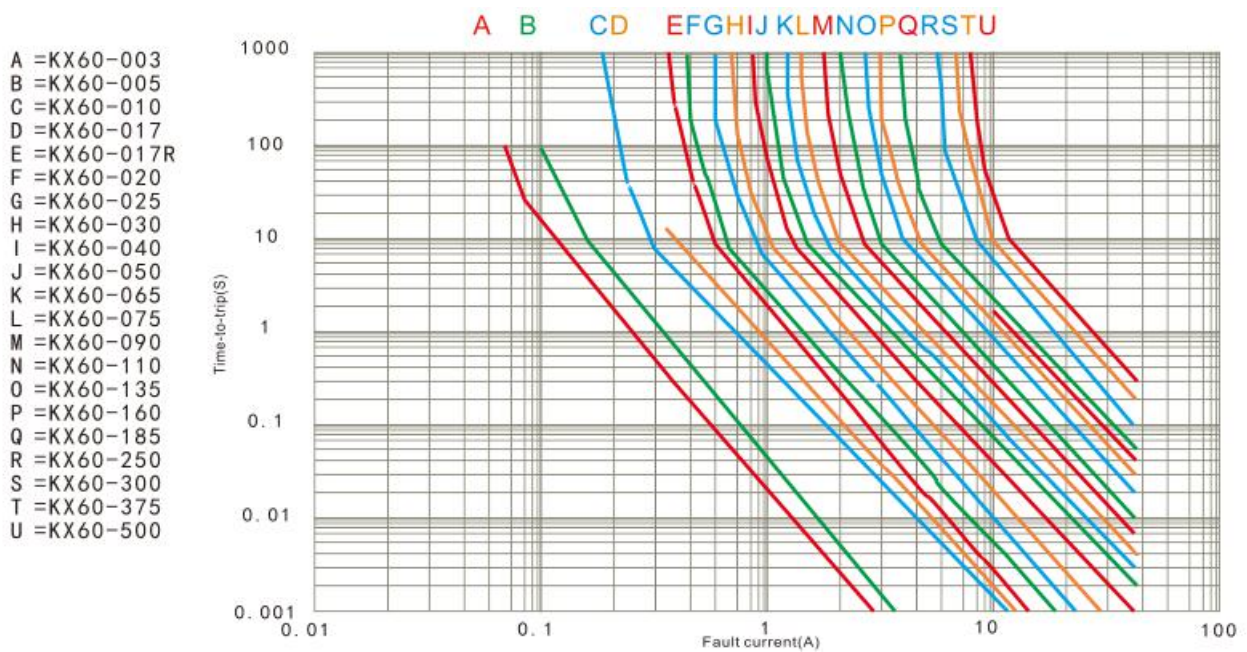

### Storage Recommendations

- Storage Temperature: -10°C~+40°C
- Relative Humidity: ≤80%RH
- Keep away from corrosive atmosphere and sunlight.
- Period of Storage: 1 year.

## X-ON Electronics

Largest Supplier of Electrical and Electronic Components

*Click to view similar products for [Resettable Fuses - PPTC](#) category:*

*Click to view products by [Kailong](#) manufacturer:*

Other Similar products are found below :

[RF0077-000](#) [RF2534-000](#) [RF3256-000](#) [RF3281-000](#) [RF3301-000](#) [RF3344-000](#) [RF3382-000](#) [SMD125-2](#) [RF2171-000](#) [RF2531-000](#) [RF2873-000](#) [RF3060-000](#) [TR600-150Q-B-0.5-0.130](#) [RXE090](#) [5E4795/04-1502](#) [TRF250-080T-B-1.0-0.125](#) [SMD100-2](#) [NIS5452MT1TXG](#) [NIS5431MT1TXG](#) [SMD250-2](#) [0ZCM0001FF2G](#) [0ZCM0003FF2G](#) [0ZCM0004FF2G](#) [BK60-017-DZ-E0.6](#) [F95456-000](#) [LVR100S](#) [RS30-090](#) [RS30-600](#) [RS30-700](#) [RS30-800](#) [RS30-900](#) [RS60RB-005](#) [RS60RB-010](#) [RS60RB-020](#) [RS60RB-025](#) [RS60RB-050](#) [RS60RB-075](#) [RS60RB-160](#) [SMD1206-300C-12V](#) [SB250-145](#) [SB250-030](#) [SB250-040](#) [SB250-200](#) [SB250-600](#) [SMD0805-005-24V](#) [SMD0805-050-16V](#) [SMD1210-005-60V](#) [SMD0805-005](#) [R60-375](#) [SMD0805K110SF6V](#)