

## LVDS Display & SATA Adapter

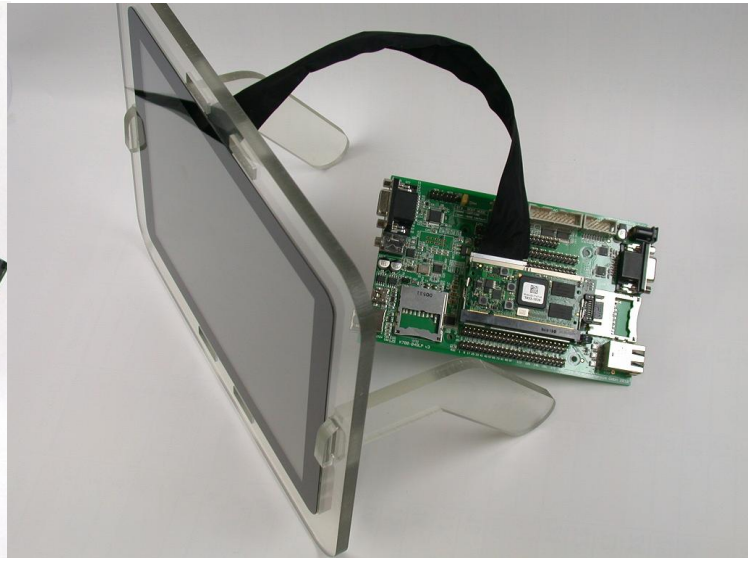

This two piece adapter supports the direct connection of Freescale's 10.1" 1024x768 (XGA) display with capacitive touch (Freescale part no.: MCIMX-LVDS1 / not included)

The first part of the adapter is plugged into the DIMM socket, fixed with screws:

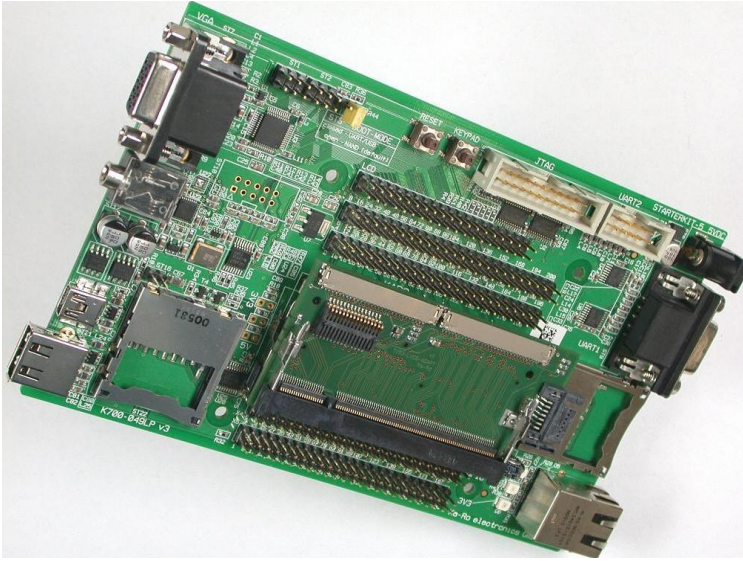
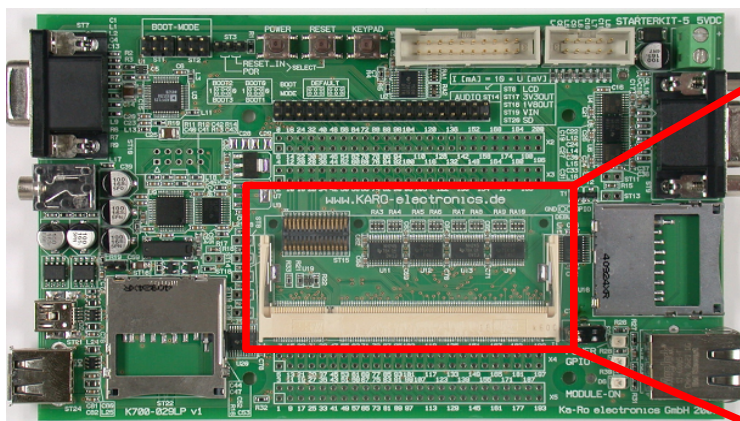
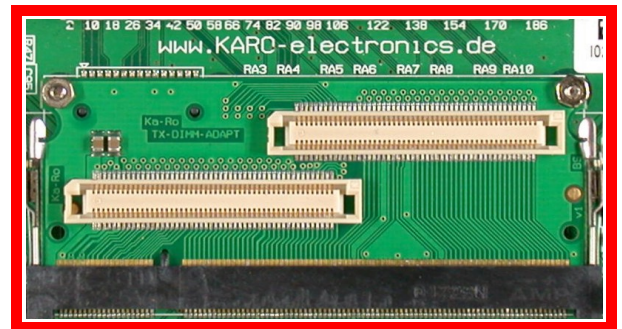

The second part is mounted on top plugged into the two 100-pin connectors:

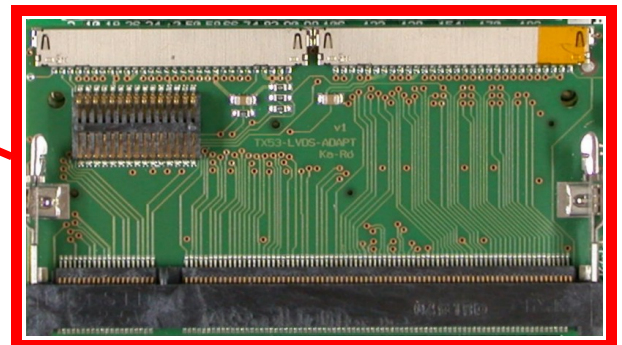

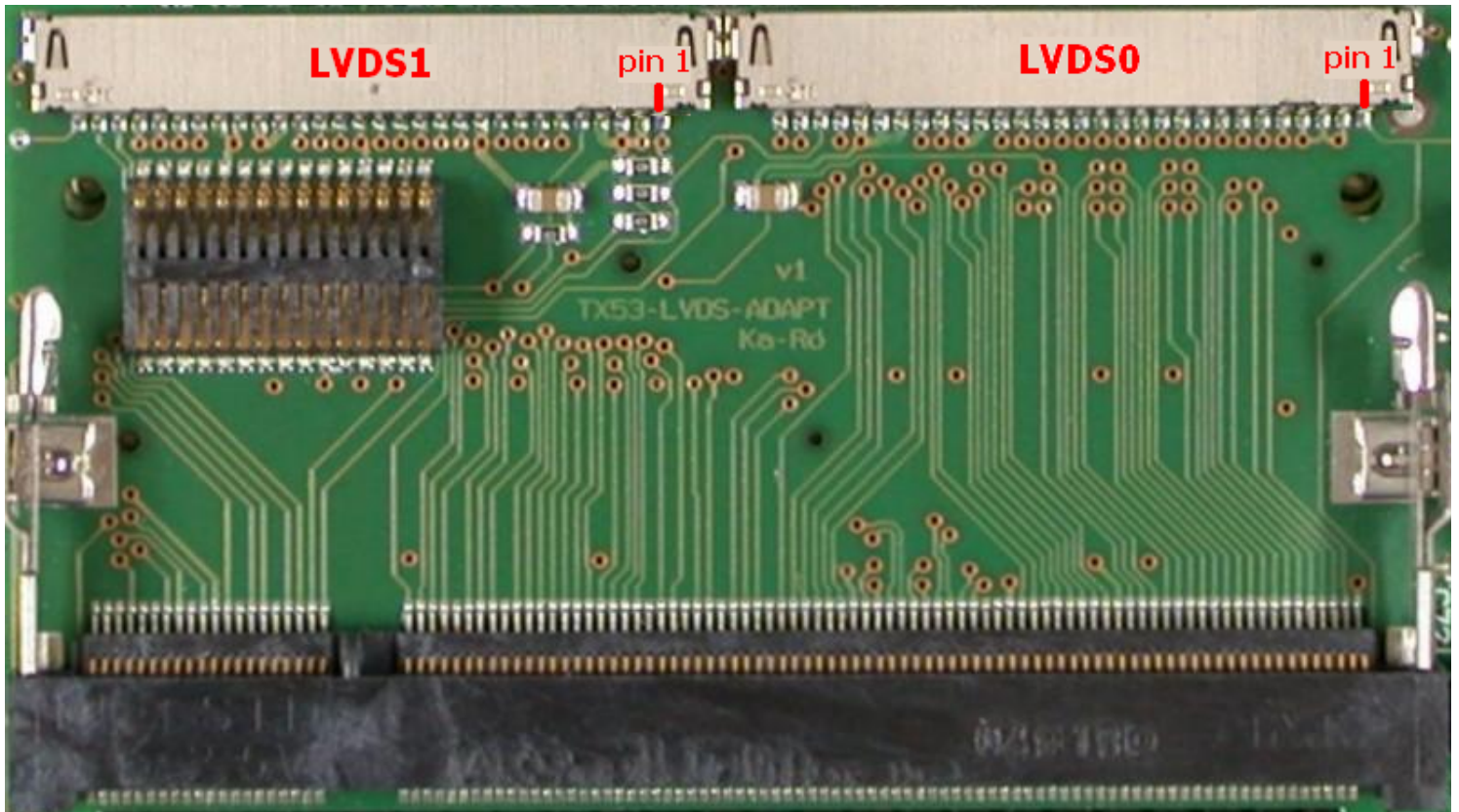

## LVDS connector used: Hirose DF19G-30P-1H



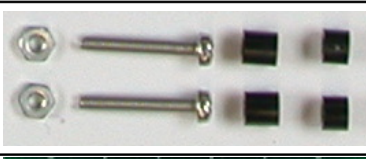
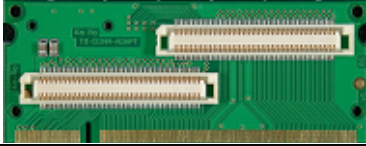
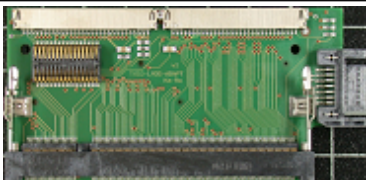

LVDS1	TX-DIMM	Remark	LVDS0	TX-DIMM
1	151	backlight on/off control (10K pull-up)	1	150
2		3.3V	2	
3		3.3V	3	
4		3.3V	4	
5	72	backlight dimming	5	42
6	121	TX3_N	6	128
7	123	TX3_P	7	126
8	122	TX0_N	8	137
9	124	TX0_P	9	135
10		GND	10	
11	118	TX1_N	11	136
12	120	TX1_P	12	134
13		GND	13	
14	117	TX2_N	14	133
15	119	TX2_P	15	131
16		GND	16	
17	125	CLK_N	17	132
18	127	CLK_P	18	130
19		GND	19	
20		5V	20	
21		5V	21	
22		GND	22	
23		GND	23	
24		5V	24	
25		5V	25	
26		5V	26	
27	75	I2C CLK (10K pull-up)	27	41
28	80	I2C SDA (10K pull-up)	28	40
29	166	TOUCH_INT (10K pull-up)	29	165
30		not connected	30	

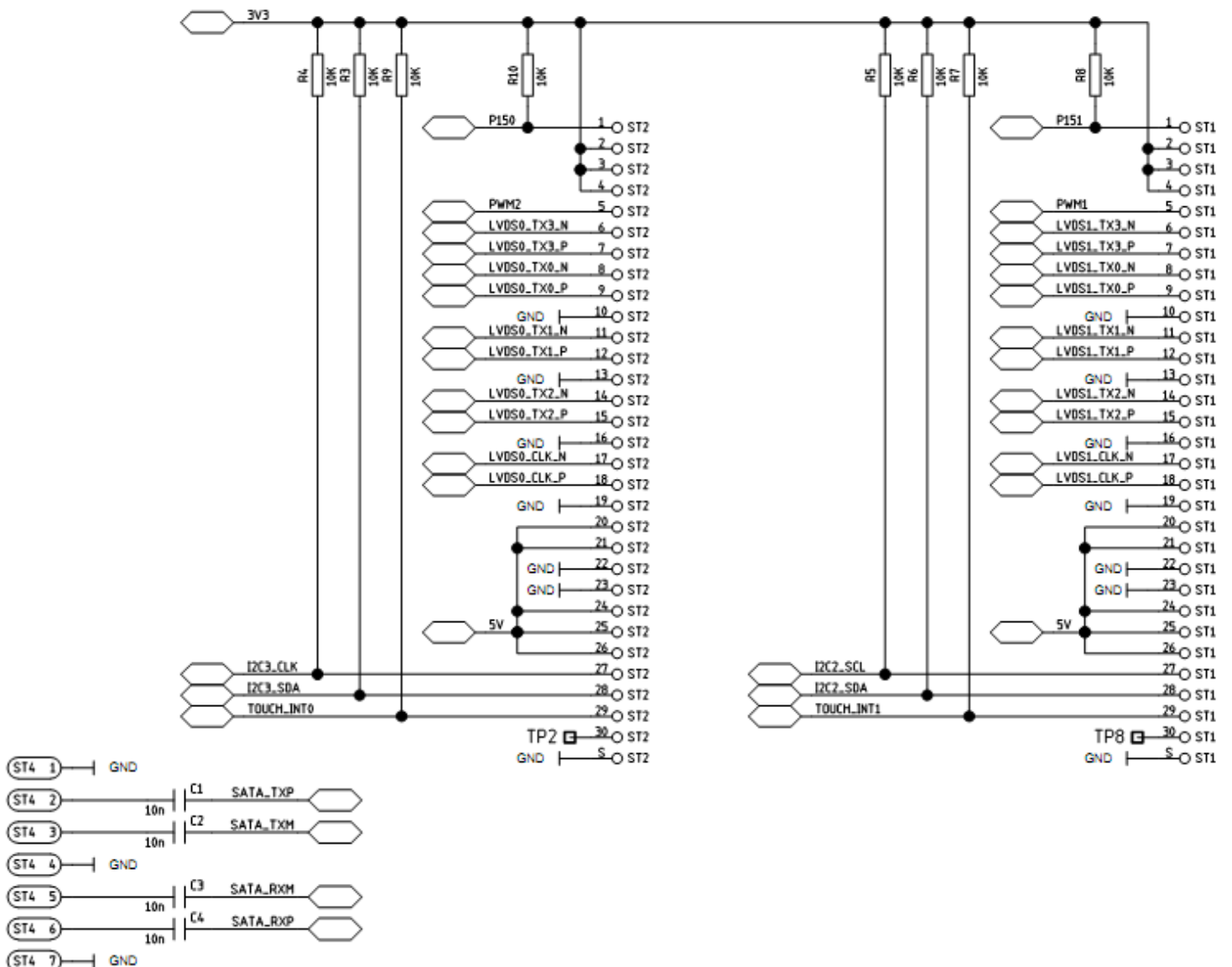
## Package contents

Item	Description	Quantity
	3.0mm self retaining M2 screw spacer	2
	4.0mm self retaining M2 screw spacer	2
	Nut M2	2
	Screw M2 x 14mm	2
	Bottom adapter	1
	Top adapter	1
	Cord power supply 5V/2A	1

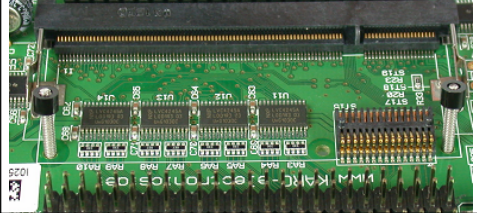

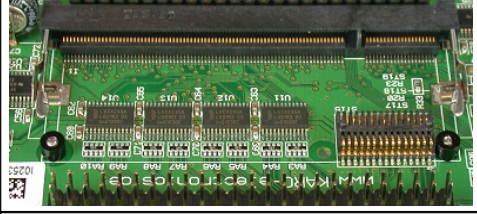
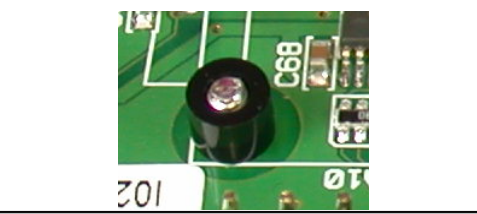
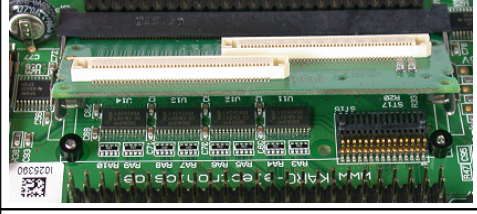
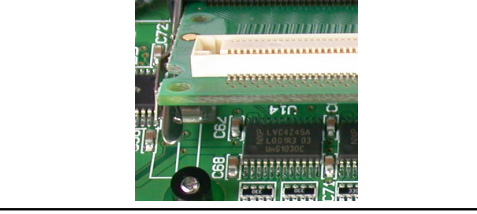
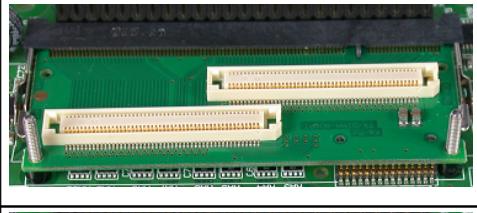
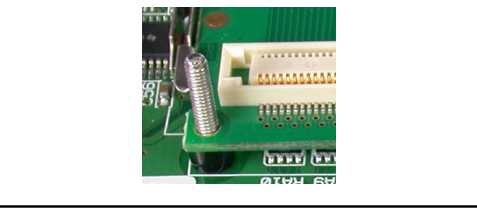
## Assembly

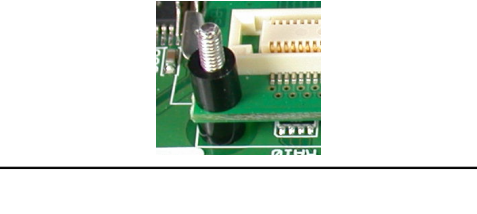
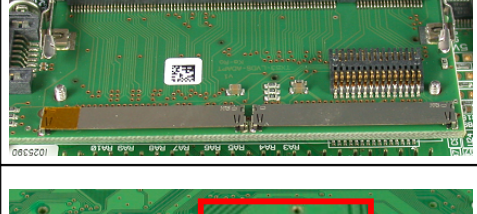
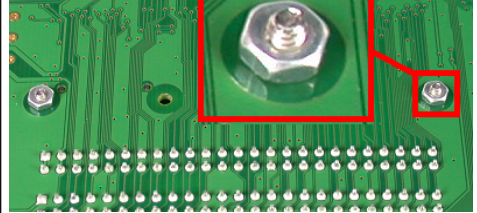
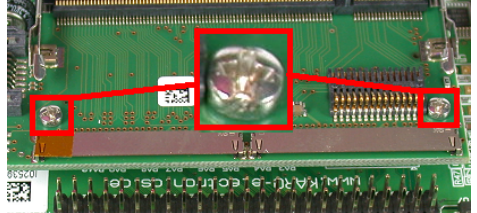
Step	Detail	Step
		1. Insert the screw from the bottom side and mount the 3mm spacer as shown.
		2. Move back the screw, the spacer will retain.
		3. Insert the bottom adapter into the DIMM socket.
		4. Lock the adapter correctly and push the screws completely through the hole.
		5. Mount the 4mm spacer on top.
		6. Put the 2 <sup>nd</sup> adapter part on top, but don't fix the screws!
		7. Step by step pull out a screw on the bottom side and insert it from the top side. <b>The nuts must be mounted on the bottom side!</b>

## X-ON Electronics

Largest Supplier of Electrical and Electronic Components

*Click to view similar products for [Sockets & Adapters](#) category:*

*Click to view products by [Ka-Ro](#) manufacturer:*

Other Similar products are found below :

[6508-0-00-01-00-00-33-0](#) [AC164348](#) [1262](#) [22827](#) [AC164353](#) [TDGL015](#) [SA247](#) [SM64TQ-ACTEL-1](#) [70-0036](#) [8.06.03](#) [DS91230+](#) [SMPA-ISP-ACTEL-3-KIT](#) [16017](#) [LFVDBGF](#) [KIT 70601-3](#) [SM132CQ-ACTEL](#) [R0E000010ACB20](#) [IPC0181](#) [IPC0175](#) [IPC0165](#) [AC164397](#) [conga-Thin MITX/eDP to DP Adapter](#) [SLG46536V-SKT](#) [SLG46621V-SKT](#) [SLG46538V-SKT](#) [SLG46535V-SKT](#) [SLG46722V-SKT](#) [ML-ADP-EVN](#) [TOOLSTICK990MPP](#) [110-83-320-41-605101](#) [110-83-632-41-605101](#) [110-83-640-41-605101](#) [110-83-628-41-605101](#) [116-83-306-41-001101](#) [PA0003](#) [PA0007](#) [PA0009](#) [PA0035](#) [PA0085](#) [PA0096](#) [IPC0079](#) [ATARD-DBGADPT](#) [80-000286](#) [ATSTK600-RC88](#) [ATSTK600-SC06](#) [ATSTK600-RC78](#) [SPC560PADPT64S](#) [AC164345](#) [AC164342](#) [AC164038](#)