

CONSTANT VOLTAGE REGULATION APPLICATION.
REFERENCE VOLTAGE APPLICATION.

FEATURES

- Small Package : USC
- Zener Voltage Tolerance
 - None Grade : About $\pm 6\%$.
 - Y Grade : About $\pm 2.5\%$.
- Suffix U : Qualified to AEC-Q101.
ex) KDZ10V-Y-RTK/HU
- Suffix A : USC(1) Package
ex) KDZ12V-Y-RTK/HA

MAXIMUM RATING (Ta=25°C)

CHARACTERISTIC	SYMBOL	RATING	UNIT
Power Dissipation	P_D^*	200	mW
Junction Temperature	T_j	150	°C
Operating Temperature	T_{opr}	-55 ~ 150	°C
Storage Temperature Range	T_{stg}	-55 ~ 150	°C

* Mounted on a glass epoxy circuit board of 20×20 mm, pad dimension of 4×4 mm.

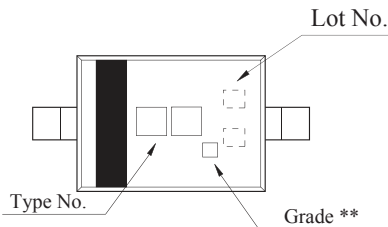

**

Grade	Symbol
None	(Blank)
Y	●

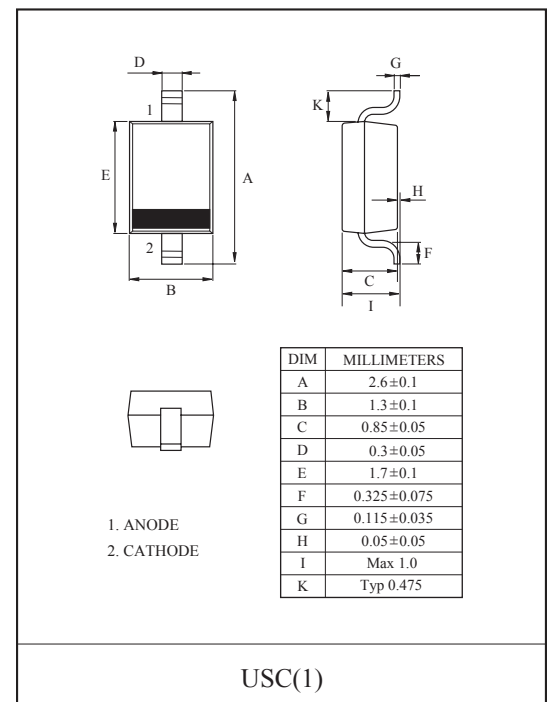
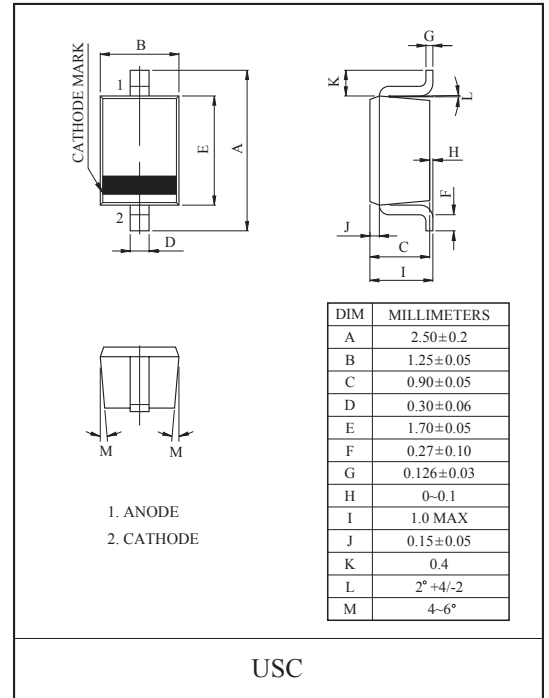

Type No.	Marking	Type No.	Marking	Type No.	Marking	Type No.	Marking
KDZ2.0V	2A	KDZ4.3V	43	KDZ9.1V	91	KDZ20V	20
KDZ2.2V	2B	KDZ4.7V	47	KDZ10V	10	KDZ22V	22
KDZ2.4V	2C	KDZ5.1V	51	KDZ11V	11	KDZ24V	24
KDZ2.7V	2D	KDZ5.6V	56	KDZ12V	12	KDZ27V	A1
KDZ3.0V	30	KDZ6.2V	62	KDZ13V	13	KDZ30V	A2
KDZ3.3V	33	KDZ6.8V	68	KDZ15V	15	KDZ33V	A3
KDZ3.6V	36	KDZ7.5V	75	KDZ16V	16	KDZ36V	7
KDZ3.9V	39	KDZ8.2V	82	KDZ18V	18	-	-

KDZ2.0V~36V

ELECTRICAL CHARACTERISTICS (T_a=25 °C)

TYPE No.	Grade	Zener Voltage Vz (V)			Dynamic Impedance Zz (Ω)		KNEE Dynamic Impedance Zzk (Ω)		Reverse Current I _R (μA)	
		Min.	Max.	I _Z (mA)	MAX.	I _Z (mA)	MAX.	I _Z (mA)	MAX.	V _R (V)
KDZ2.0V	-	1.85	2.15	5	100	5	1000	0.5	120	1.0
	Y	1.95	2.15							
KDZ2.2V	-	2.05	2.38	5	100	5	1000	0.5	120	1.0
	Y	2.16	2.38							
KDZ2.4V	-	2.28	2.60	5	100	5	1000	0.5	120	1.0
	Y	2.40	2.60							
KDZ2.7V	-	2.50	2.90	5	110	5	1000	0.5	120	1.0
	Y	2.65	2.90							
KDZ3.0V	-	2.80	3.20	5	120	5	1000	0.5	50	1.0
	Y	2.95	3.20							
KDZ3.3V	-	3.10	3.50	5	130	5	1000	0.5	20	1.0
	Y	3.25	3.50							
KDZ3.6V	-	3.40	3.80	5	130	5	1000	0.5	10	1.0
	Y	3.60	3.845							
KDZ3.9V	-	3.70	4.10	5	130	5	1000	0.5	10	1.0
	Y	3.890	4.160							
KDZ4.3V	Y	4.170	4.430	5	130	5	1000	0.5	5	1.0
KDZ4.7V	Y	4.550	4.750	5	120	5	1000	0.5	5	1.0
KDZ5.1V	Y	4.980	5.200	5	70	5	1000	0.5	1	1.5
KDZ5.6V	Y	5.490	5.730	5	40	5	900	0.5	1	2.5
KDZ6.2V	Y	6.060	6.330	5	30	5	500	0.5	1	3.0
KDZ6.8V	Y	6.650	6.930	5	25	5	150	0.5	0.5	5.0
KDZ7.5V	Y	7.280	7.600	5	23	5	120	0.5	0.5	6.0
KDZ8.2V	Y	8.020	8.360	5	20	5	120	0.5	0.5	6.5
KDZ9.1V	Y	8.850	9.230	5	18	5	120	0.5	0.5	7.0
KDZ10V	Y	9.770	10.210	5	15	5	120	0.5	0.5	8.0

KDZ2.0V~36V

ELECTRICAL CHARACTERISTICS (Continuous, Ta=25°C)

TYPE No.	Grade	Zener Voltage Vz (V)			Dynamic Impedance Zz (Ω)		KNEE Dynamic Impedance Zzk (Ω)		Reverse Current IR (μA)	
		Min.	Max.	Iz (mA)	MAX.	Iz (mA)	MAX.	Iz (mA)	MAX.	VR(V)
KDZ11V	Y	10.760	11.220	5	15	5	120	0.5	0.5	8.5
KDZ12V	Y	11.740	12.240	5	15	5	110	0.5	0.5	9.0
KDZ13V	Y	12.910	13.490	5	15	5	110	0.5	0.5	10
KDZ15V	Y	14.340	14.980	5	15	5	110	0.5	0.5	11
KDZ16V	Y	15.850	16.510	5	18	5	150	0.5	0.5	12
KDZ18V	Y	17.560	18.350	5	20	5	150	0.5	0.5	14
KDZ20V	Y	19.520	20.390	5	25	5	200	0.5	0.5	15
KDZ22V	Y	21.540	22.470	5	30	5	200	0.5	0.5	17
KDZ24V	Y	23.720	24.780	5	40	5	200	0.5	0.5	19
KDZ27V	-	26.19	27.53	2	150	2	150	0.5	0.1	21
KDZ30V	-	29.19	30.69		200		200			23
KDZ33V	-	32.15	33.79		250		250			25
KDZ36V	-	35.07	36.87		300		300			27

KDZ2.0V~36V

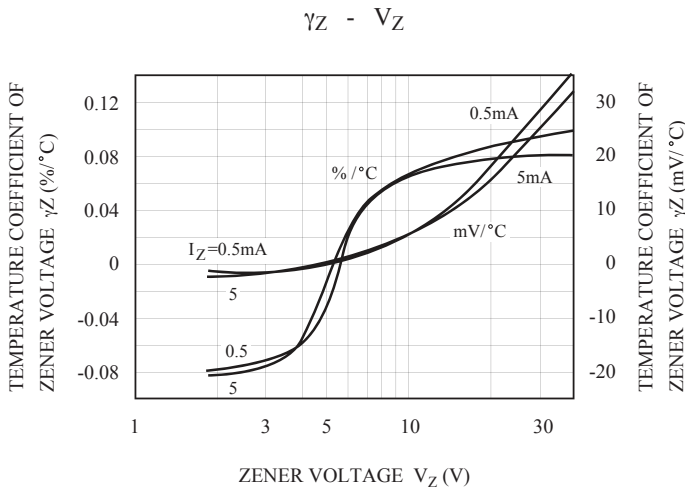
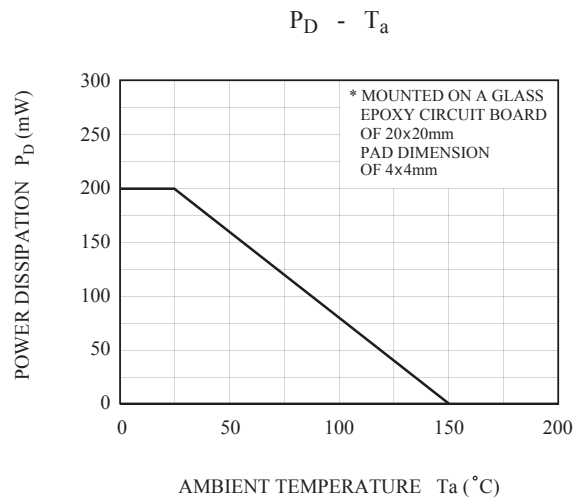
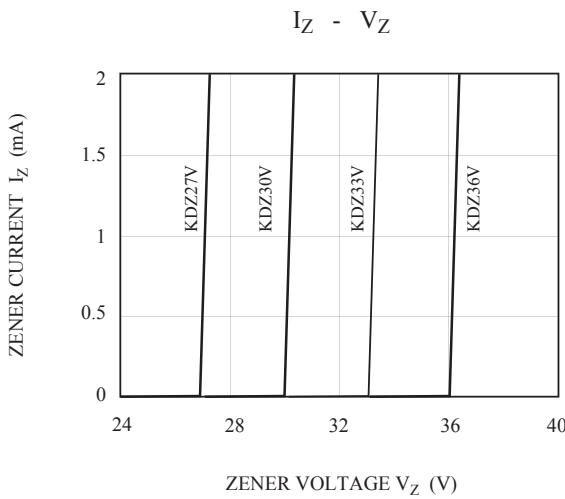
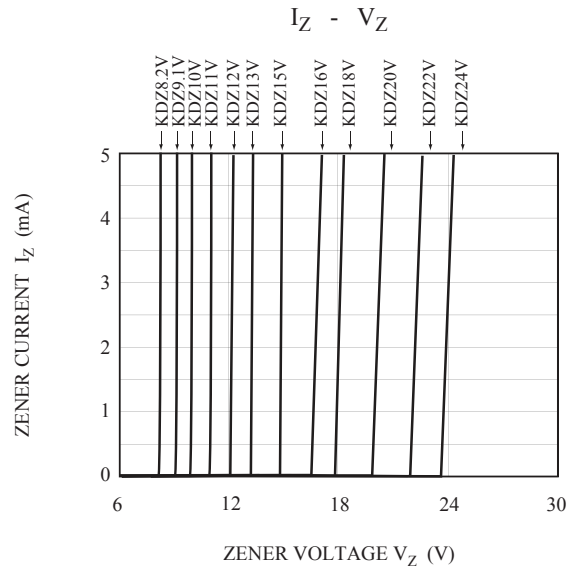
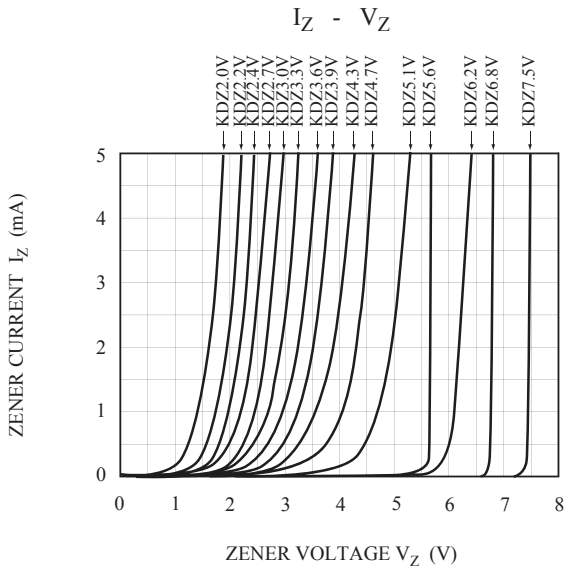

X-ON Electronics

Largest Supplier of Electrical and Electronic Components

Click to view similar products for [Zener Diodes](#) category:

Click to view products by [KEC](#) manufacturer:

Other Similar products are found below :

[RKZ13B2KG#P1](#) [DL5234B](#) [1N4682](#) [1N4693](#) [1N4732A](#) [1N4736A](#) [1N4750A](#) [1N4759ARL](#) [1N5241B](#) [1N5365B](#) [1N5369B](#) [1N747A](#)
[1N964B](#) [1N966B](#) [1N968B](#) [1N972B](#) [JANS1N4974US](#) [1N4692](#) [1N4702](#) [1N4704](#) [1N4711](#) [1N4714](#) [1N4745ARL](#) [1N4752ARL](#) [1N4760ARL](#)
[1N5221B](#) [1N5242BTR](#) [1N5350B](#) [1N5352B](#) [1N961BRR1](#) [1N964BRL](#) [RKZ5.1BKU#P6](#) [3SMAJ5946B-TP](#) [3SMAJ5950B-TP](#)
[MMSZ5230BQ-13-F](#) [MMSZ5232BQ-13-F](#) [BZX84C7V5](#) [3SMAJ5945B-TP](#) [3SMAJ5947B-TP](#) [3SMBJ5941B-TP](#) [DZ2S240M0L](#) [SMAZ27-](#)
[TP](#) [ZMM5224B-7](#) [RD16UM-T1-A](#) [RD39S-T1-A](#) [RD10S-T1-A](#) [CDZT2R5.6B](#) [1N4762A G](#) [Z1SMA18](#) [JANTX1N4553B](#)