

### 4 TERMINAL 3A OUTPUT LOW DROP VOLTAGE REGULATOR

The KIA378R × × Series are Low Drop Voltage Regulator suitable for various electronic equipments. It provides constant voltage power source with TO-220IS-4 terminal lead full molded PKG.

The Regulator has multi-function such as over current protection, overheat protection and ON/OFF control.

#### FEATURES

- 3.0A Output Low Drop Voltage Regulator.
- Built in ON/OFF Control Terminal.
- Built in Over Current Protection, Over Heat Protection Function.

#### LINE UP

ITEM	OUTPUT VOLTAGE (Typ.)	UNIT
KIA378R05PI	5	V
KIA378R06PI	6	
KIA378R08PI	8	
KIA378R09PI	9	
KIA378R10PI	10	
KIA378R12PI	12	
KIA378R15PI	15	

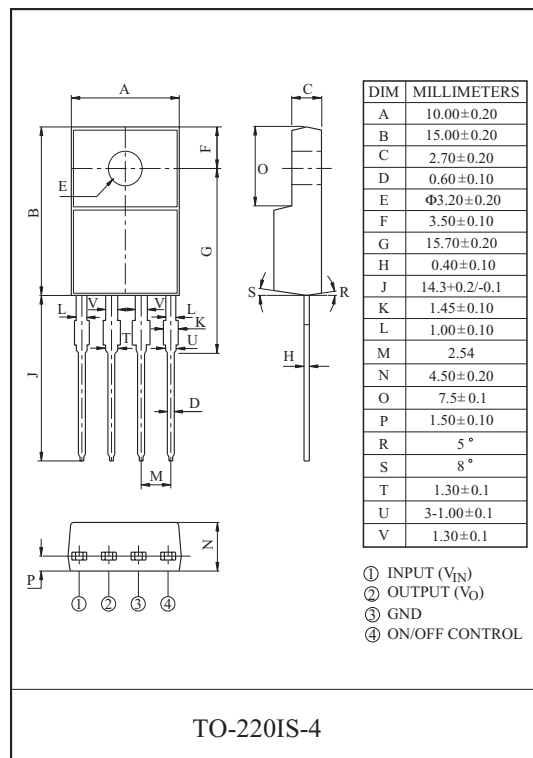

#### MAXIMUM RATINGS (T<sub>a</sub>=25 °C)

CHARACTERISTIC	SYMBOL	RATING	UNIT	Remark
Input Voltage	V <sub>IN</sub>	35	V	-
ON/OFF Control Voltage	V <sub>C</sub>	35	V	-
Output Current	I <sub>O</sub>	3	A	-
Power Dissipation 1	P <sub>d1</sub>	1.5	W	No heatsink
Power Dissipation 2	P <sub>d2</sub>	15	W	with heatsink
Operating Junction Temperature	T <sub>J(opr)</sub>	-40 ~ 150	°C	-
Storage Temperature	T <sub>stg</sub>	-45 ~ 150	°C	-
Soldering Temperature (10sec)	T <sub>sol</sub>	260	°C	-

# KIA378R05PI~KIA378R15PI

## ELECTRICAL CHARACTERISTICS (Unless otherwise specified, $I_O=1.0A$ , $T_a=25\text{ }^\circ\text{C}$ , Note1.)

CHARACTERISTIC	SYMBOL	CONDITIONS	MIN.	TYP.	MAX.	UNIT
Output Voltage	KIA378R05	-	4.88	5.0	5.12	V
	KIA378R06	-	5.85	6.0	6.15	
	KIA378R08	-	7.80	8.0	8.2	
	KIA378R09	-	8.78	9.0	9.22	
	KIA378R10	-	9.75	10.0	10.25	
	KIA378R12	-	11.70	12.0	12.30	
	KIA378R15	-	14.70	15.0	15.30	
Load Regulation	Reg Load	$I_O=5\text{mA} \sim 3\text{A}$	-	0.1	2.0	%
Line Regulation	Reg Line	(Note 2)	-	0.5	2.5	%
Temperature Coefficient of Output Voltage	$T_C V_O$	$T_j=0 \sim 125\text{ }^\circ\text{C}$	-	$\pm 0.02$	$\pm 0.05$	%/ $^\circ\text{C}$
Ripple Rejection	$R \cdot R$	-	45	55	-	dB
Drop Out Voltage	$V_D$	$I_O=3\text{A}$	-	-	0.5	V
Output ON state for control Voltage	$V_{C(ON)}$	-	2.0	-	-	V
Output ON state for control Current	$I_{C(ON)}$	$V_C=2.7\text{V}$	-	-	20	$\mu\text{A}$
Output OFF state for control Voltage	$V_{C(OFF)}$	-	-	-	0.8	V
Output OFF state for control Current	$I_{C(OFF)}$	$V_C=0.4\text{V}$	-	-	-0.4	mA
Quiescent Current	$I_Q$	$I_O=0$	-	-	10	mA

Note1)  $V_{IN}$  of KIA378R05=7V

Note2)  $V_{IN}$  of KIA378R05=6~12V

Note3) At  $V_{IN}=0.95V_O$

" KIA378R06=8V

" KIA378R06=7~15V

" KIA378R08=10V

" KIA378R08=9~25V

" KIA378R09=15V

" KIA378R09=10~25V

" KIA378R10=16V

" KIA378R10=11~26V

" KIA378R12=18V

" KIA378R12=13~29V

" KIA378R15=21V

" KIA378R15=16~32V

## BLOCK DIAGRAM

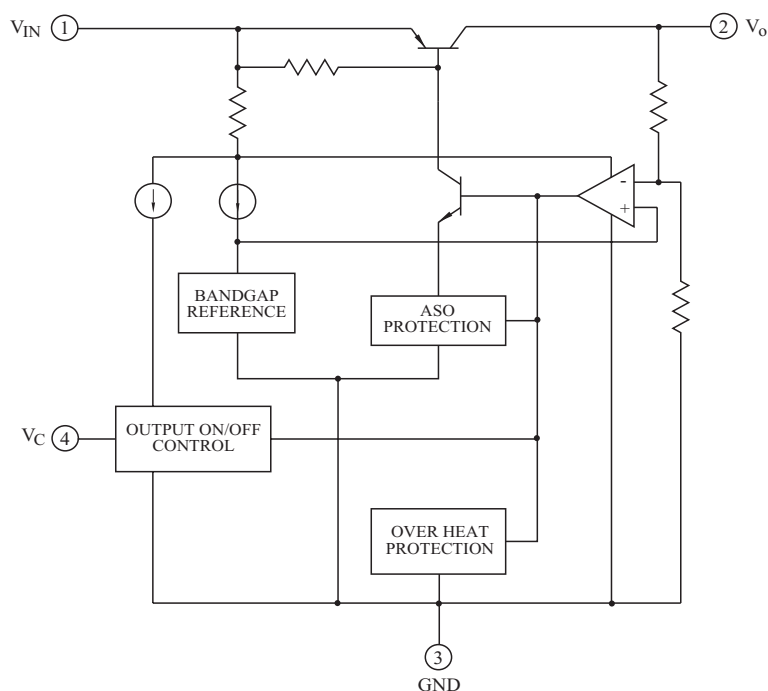

# KIA378R05PI~KIA378R15PI

Fig. 1 Standard Test Circuit

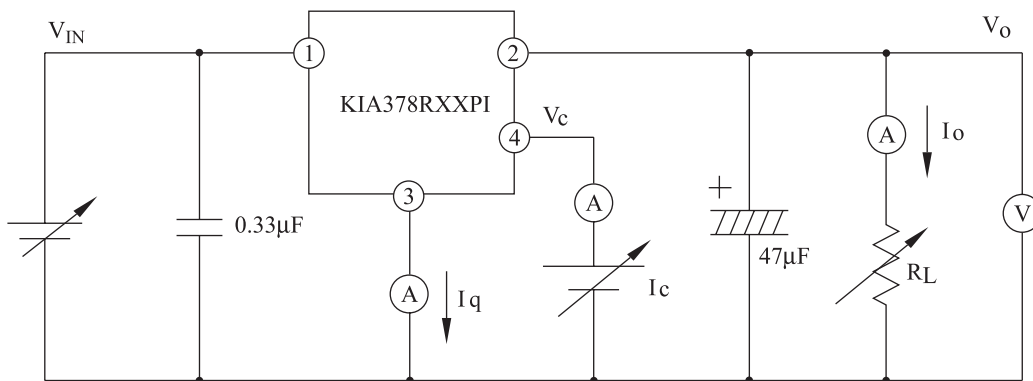

Fig. 1-2 Ripple Rejection Test Circuit

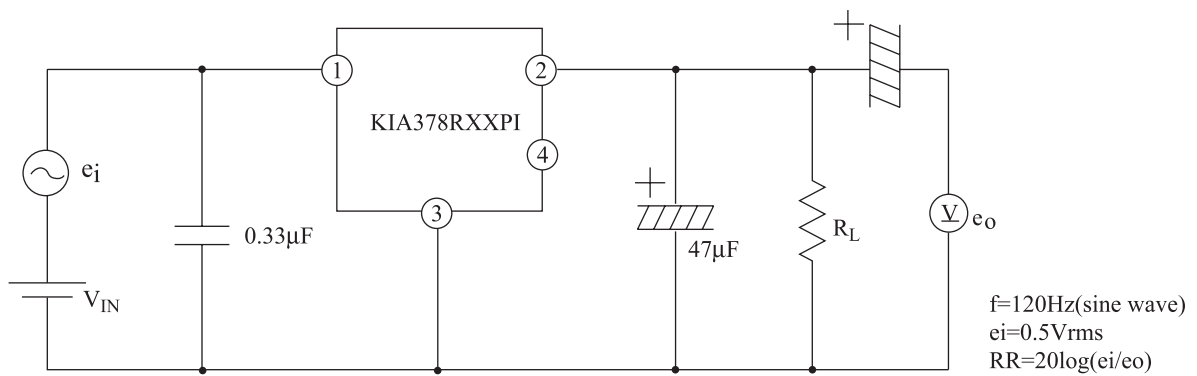
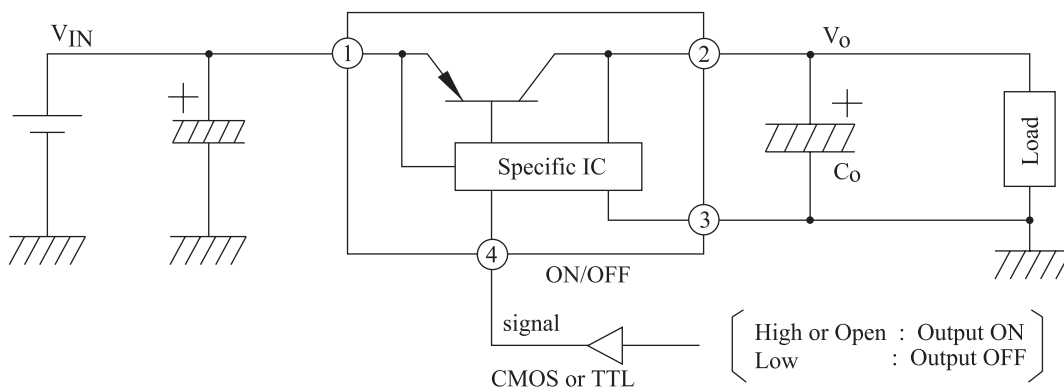
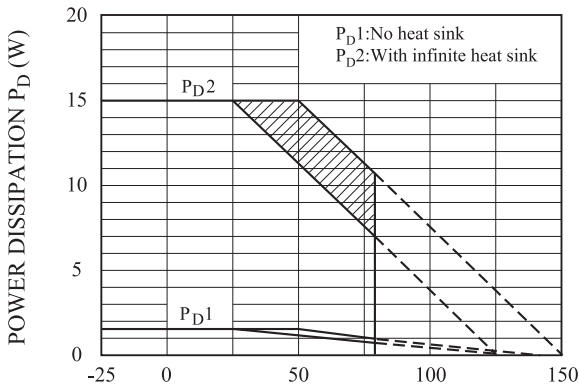

Fig. 2 Application Circuit for Standard



# KIA378R05PI~KIA378R15PI

Fig.3  $T_a$  -  $P_D$



AMBIENT TEMPERATURE  $T_a$  (°C)

Note) Oblique line portion : Overheat protection may operate in this area.

Fig.4  $I_O$  -  $V_O$

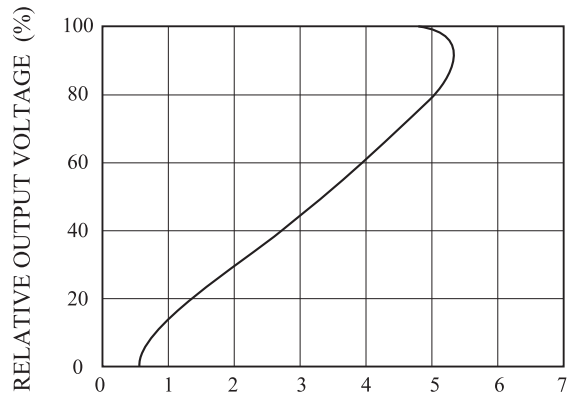

OUTPUT CURRENT  $I_O$  (A)

Fig.5-1  $T_j$  -  $\Delta V_O$  (KIA378R05)

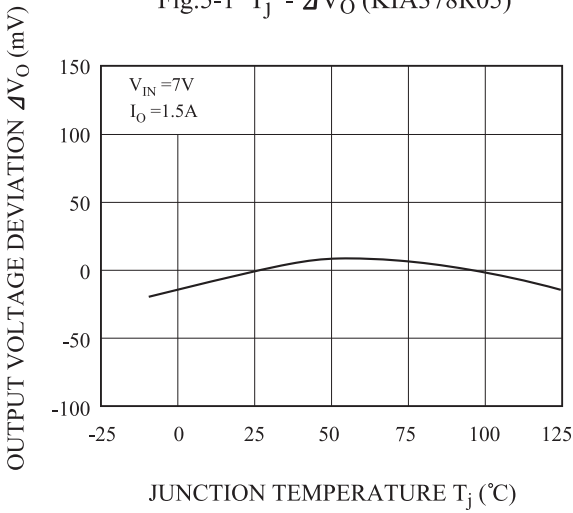

JUNCTION TEMPERATURE  $T_j$  (°C)

Fig.5-2  $T_j$  -  $\Delta V_O$  (KIA378R08)

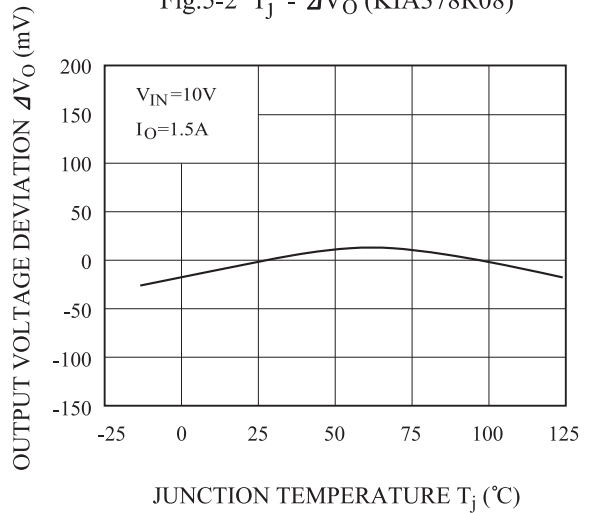

JUNCTION TEMPERATURE  $T_j$  (°C)

Fig.5-3  $T_j$  -  $\Delta V_O$  (KIA378R09)

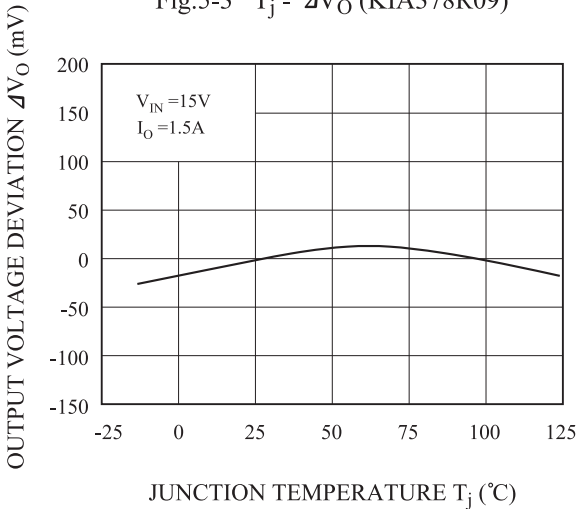

JUNCTION TEMPERATURE  $T_j$  (°C)

Fig.5-4  $T_j$  -  $\Delta V_O$  (KIA378R12)

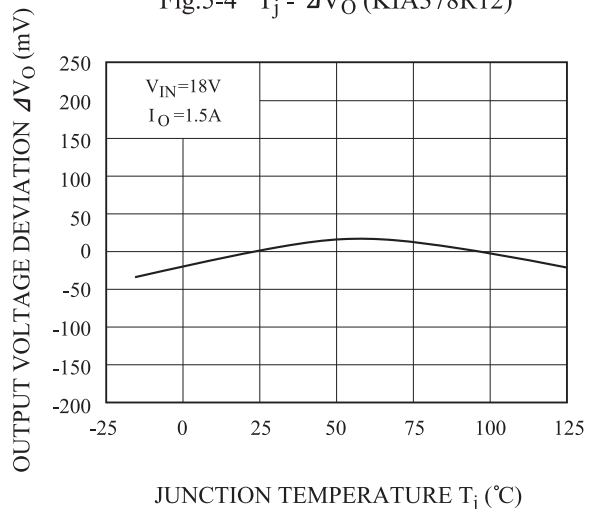

JUNCTION TEMPERATURE  $T_j$  (°C)

# KIA378R05PI~KIA378R15PI

Fig.5-5  $T_j - \Delta V_O$  (KIA378R15)

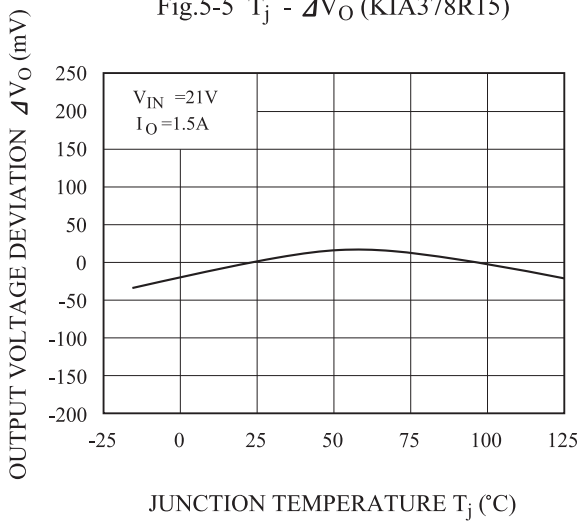

Fig.6-1  $V_{IN} - V_O$  (KIA378R05)

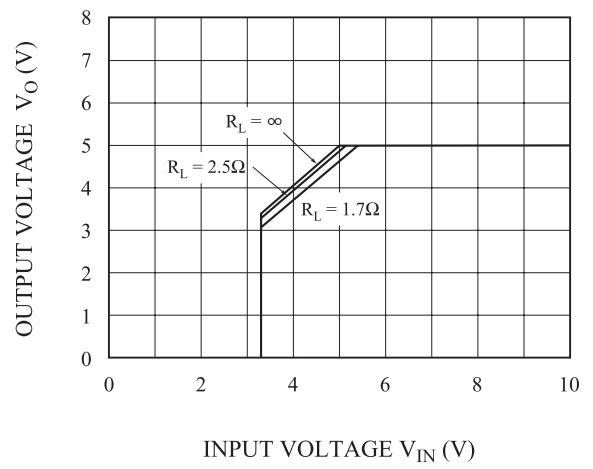

Fig.6-2  $V_{IN} - V_O$  (KIA378R08)

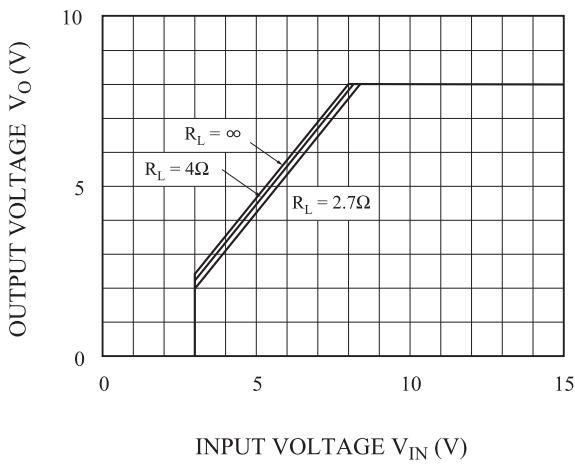

Fig.6-3  $V_{IN} - V_O$  (KIA378R09)

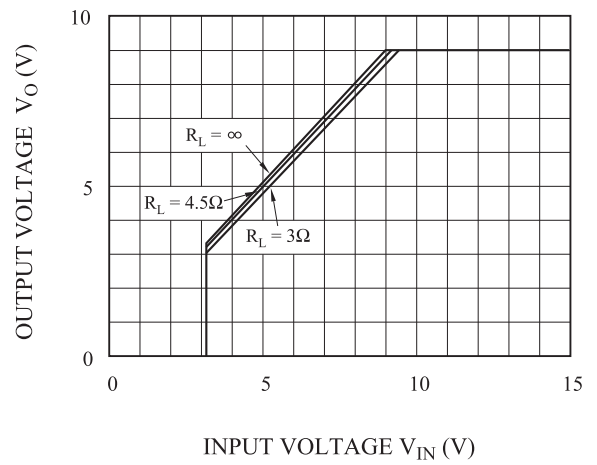

Fig.6-4  $V_{IN} - V_O$  (KIA378R12)

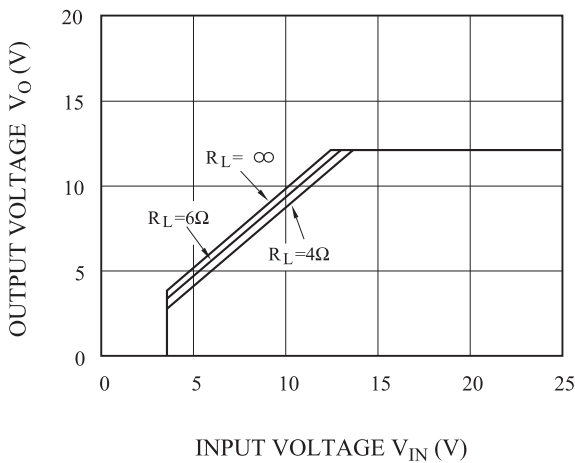
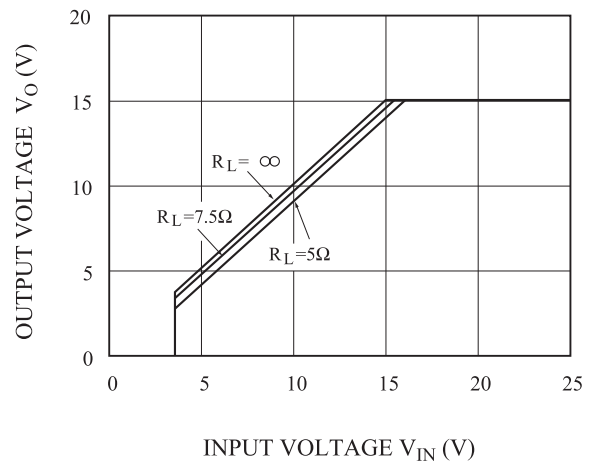

Fig.6-5  $V_{IN} - V_O$  (KIA378R15)



# KIA378R05PI~KIA378R15PI

Fig.7-1  $V_{IN} - I_{BIAS}$  (KIA378R05)

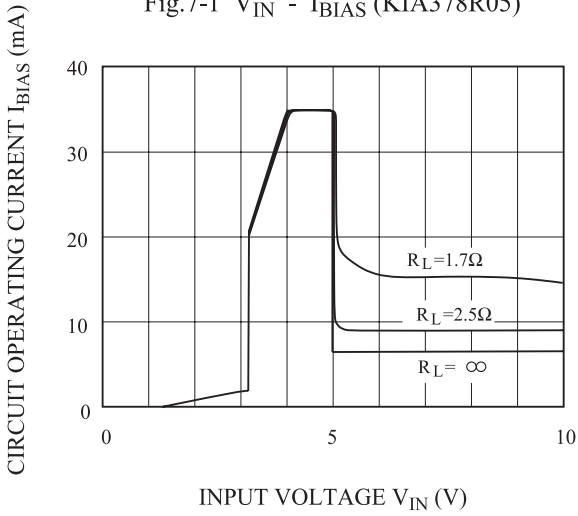

Fig.7-2  $V_{IN} - I_{BIAS}$  (KIA378R08)

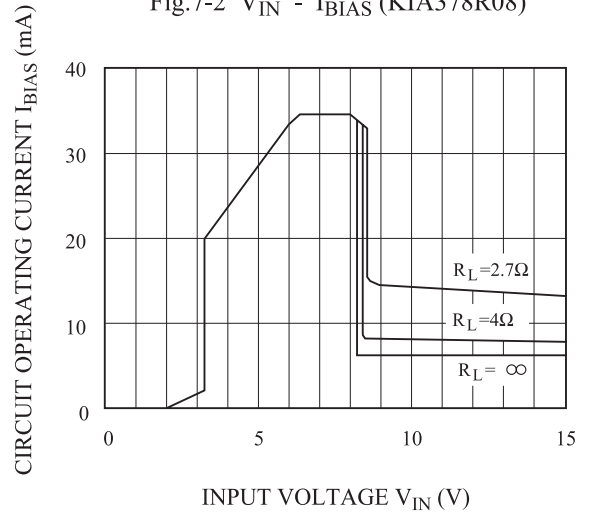

Fig.7-3  $V_{IN} - I_{BIAS}$  (KIA378R09)

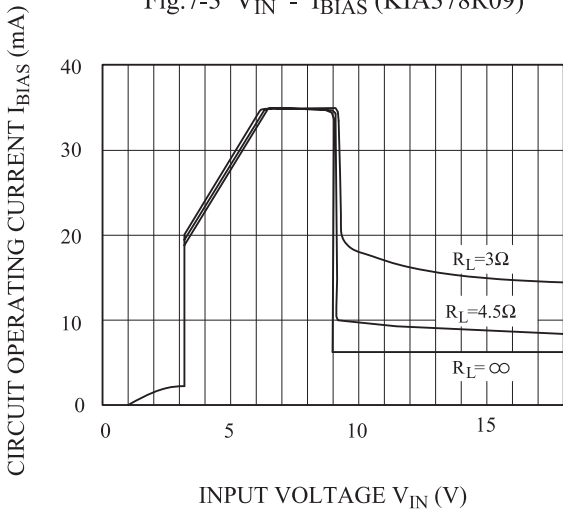

Fig.7-4  $V_{IN} - I_{BIAS}$  (KIA378R12)

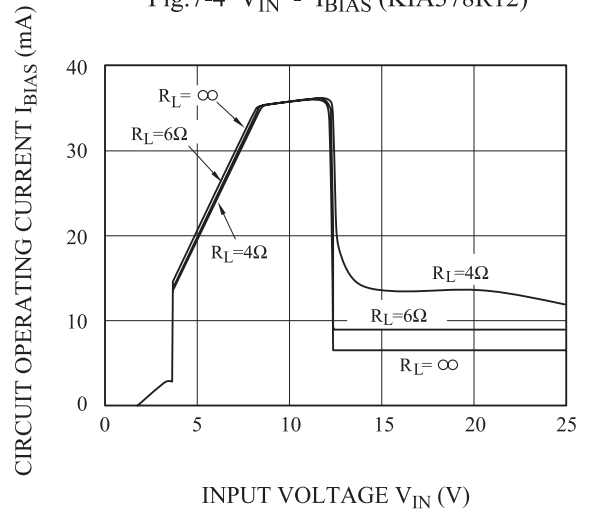

Fig.7-5  $V_{IN} - I_{BIAS}$  (KIA378R15)

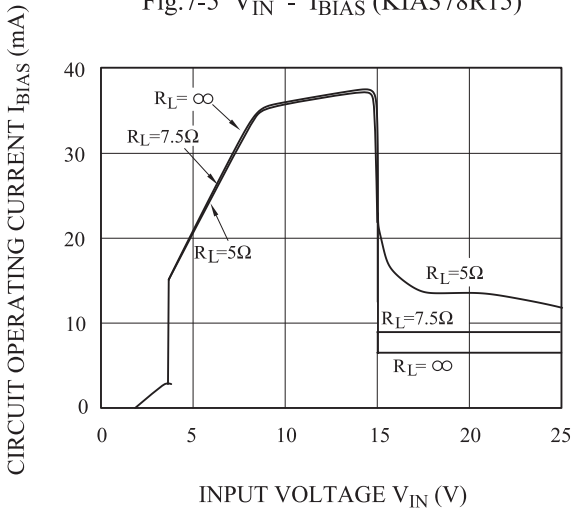
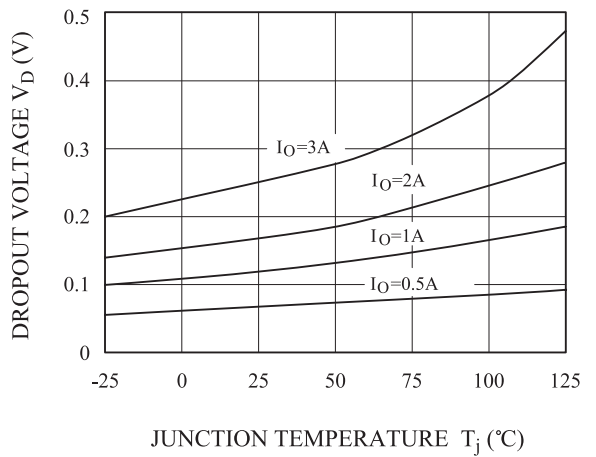

Fig.8  $T_j - V_D$



# KIA378R05PI~KIA378R15PI

Fig.9  $T_j - I_q$

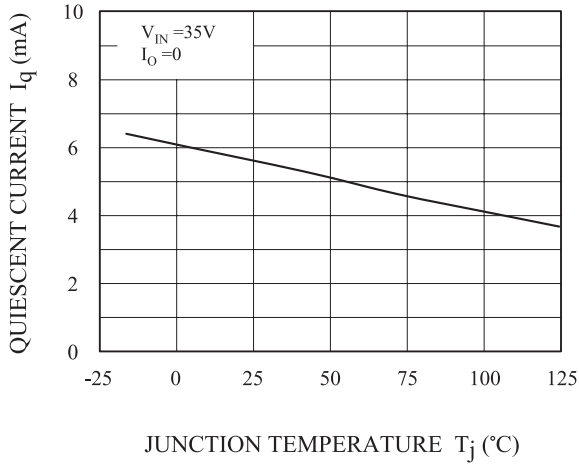

Fig. 10-1  $f - RR$

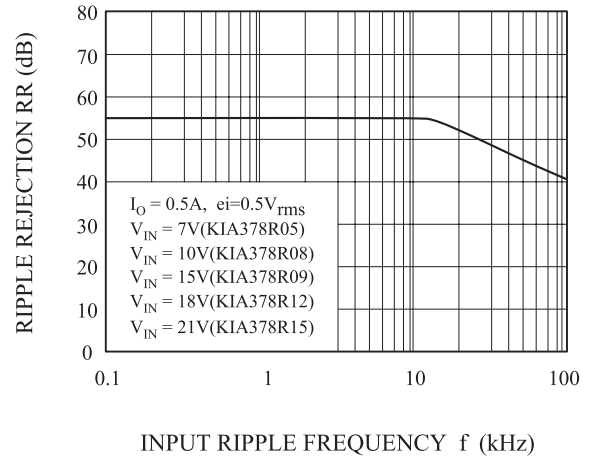
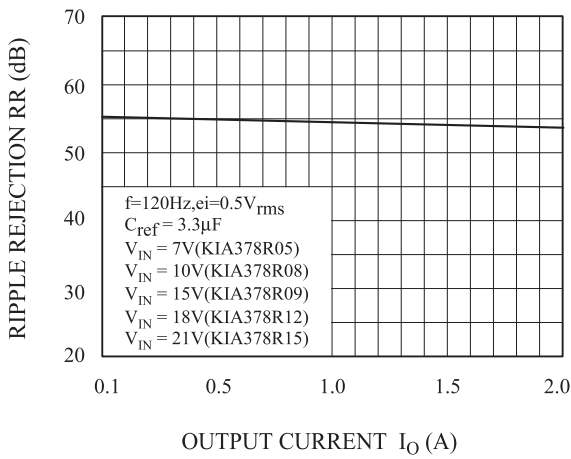

Fig.10-2  $I_O - RR$



## X-ON Electronics

Largest Supplier of Electrical and Electronic Components

*Click to view similar products for [LDO Voltage Regulators](#) category:*

*Click to view products by [KEC](#) manufacturer:*

Other Similar products are found below :

[AP7363-SP-13](#) [L79M05TL-E](#) [AP7362-HA-7](#) [PT7M8202B12TA5EX](#) [TCR3DF185,LM\(CT](#) [TCR3DF45,LM\(CT](#) [TLE4473G V52](#) [059985X](#)  
[NCP4687DH15T1G](#) [701326R](#) [NCV8170AXV250T2G](#) [AP7315-25W5-7](#) [AP2111H-1.2TRG1](#) [ZLDO1117QK50TC](#) [AZ1117ID-ADJTRG1](#)  
[TCR3DG12,LF](#) [MIC5514-3.3YMT-T5](#) [SCD7912BTG](#) [NCP154MX180270TAG](#) [SCD33269T-5.0G](#) [NCV8170BXV330T2G](#)  
[NCV8170BMX330TCG](#) [NCV8170AMX120TCG](#) [NCP706ABMX300TAG](#) [NCP153MX330180TCG](#) [NCP114BMX075TCG](#) [MC33269T-3.5G](#)  
[CAT6243-ADJCMT5T](#) [TCR3DG33,LF](#) [TCR4DG35,LF](#) [TAR5S15U\(TE85L,F\)](#) [TAR5S18U\(TE85L,F\)](#) [TCR3UG19A,LF](#) [TCR4DG105,LF](#)  
[MPQ2013AGG-5-P](#) [NCV8170AMX360TCG](#) [TLE4268GSXUMA2](#) [NCP715SQ15T2G](#) [MIC5317-3.0YD5-T5](#) [NCV563SQ18T1G](#)  
[NCP715MX30TBG](#) [NCV8702MX25TCG](#) [NCV8170BXV120T2G](#) [MIC5317-1.2YD5-T5](#) [NCV8170AMX150TCG](#) [NCV8170BMX150TCG](#)  
[AP2213D-3.3TRG1](#) [NCV8170BMX120TCG](#) [NCV8170BMX310TCG](#) [NCV8170BMX360TCG](#)