

THREE TERMINAL POSITIVE VOLTAGE REGULATORS
5V, 6V, 8V, 9V, 10V, 12V, 15V, 18V, 20V, 24V.

FEATURES

- Best Suited to a Power Supply for TTL and CMOS.
- Built-in Overcurrent Protective Circuit.
- Built-in Thermal Protective Circuit.
- Max. Output Current 150mA ($T_j=25^\circ\text{C}$).
- Packaged in TO-92L.

MAXIMUM RATINGS ($T_a=25^\circ\text{C}$)

CHARACTERISTIC		SYMBOL	RATING	UNIT
Input Voltage	KIA79L05BP ~ KIA79L15BP	V_{IN}	-35	V
	KIA79L18BP ~ KIA79L24BP		-40	
Power Dissipation ($T_c=25^\circ\text{C}$)		P_D	800	mW
Operating Junction Temperature		T_j	-30 ~ 150	$^\circ\text{C}$
Operating Temperature		T_{opr}	-30 ~ 75	$^\circ\text{C}$
Storage temperature		T_{stg}	-55 ~ 150	$^\circ\text{C}$

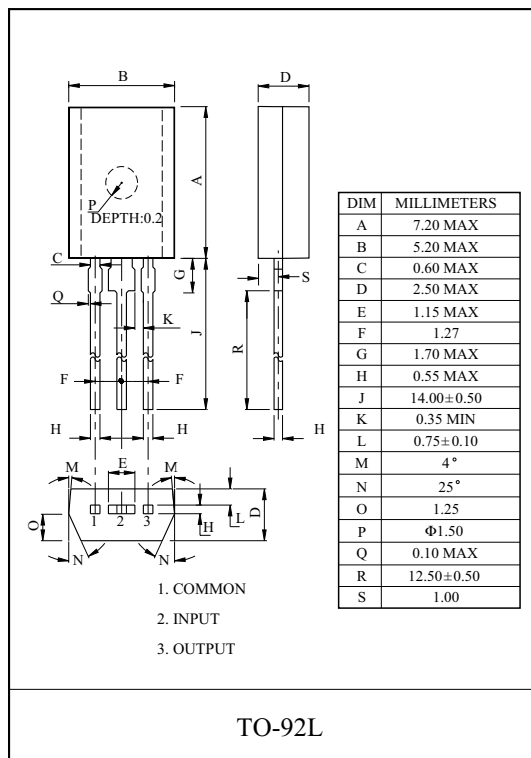

EQUIVALENT CIRCUIT

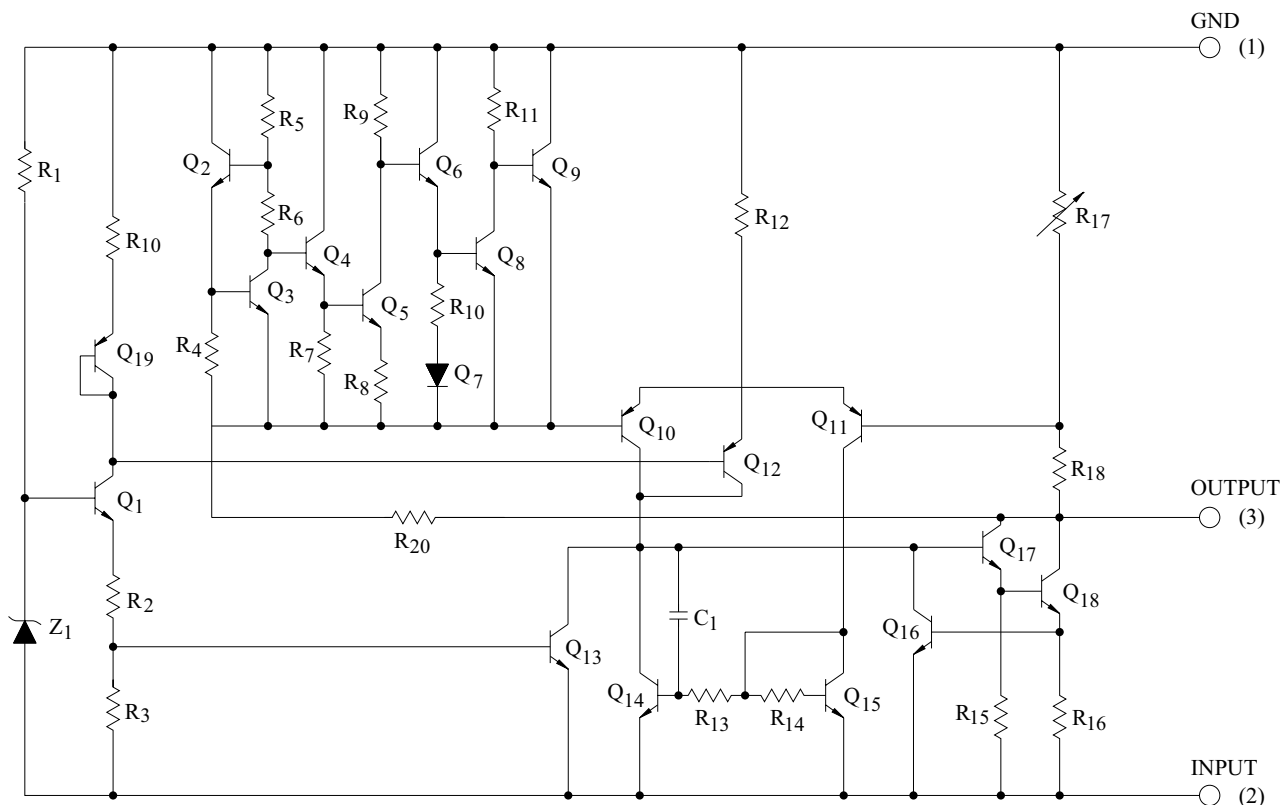

KIA79L05BP~KIA79L24BP

ELECTRICAL CHARACTERISTICS

KIA79L05BP

(Unless otherwise specified, $V_{IN}=-10V$, $I_{OUT}=40mA$, $C_{IN}=0.33\mu F$, $C_{OUT}=0.1\mu F$, $0^{\circ}C \leq T_j \leq 125^{\circ}C$)

CHARACTERISTIC	SYMBOL	TEST CIRCUIT	TEST CONDITION	MIN.	TYP.	MAX.	UNIT	
Output Voltage	V_{OUT}	1	$T_j=25^{\circ}C$	-5.2	-5.0	-4.8	V	
Input Regulation	Reg line	1	$T_j=25^{\circ}C$	$-20V \leq V_{IN} \leq -7.0V$	-	55	150	mV
				$-20V \leq V_{IN} \leq -8.0V$	-	45	100	
Load Regulation	Reg load	1	$T_j=25^{\circ}C$	$1.0mA \leq I_{OUT} \leq 100mA$	-	11	60	mV
				$1.0mA \leq I_{OUT} \leq 40mA$	-	5.0	30	
Output Voltage	V_{OUT}	1	$-20V \leq V_{IN} \leq -7.0V$ $1.0mA \leq I_{OUT} \leq 40mA$	-5.25	-	-4.75	V	
			$V_{IN}=-10V$, $1.0mA \leq I_{OUT} \leq 70mA$	-5.25	-	-4.75		
Quiescent Current	I_B	1	$T_j=25^{\circ}C$	-	3.1	6.0	mA	
			$T_j=125^{\circ}C$	-	-	5.5		
Quiescent Current Change	ΔI_{BI}	1	$-20V \leq V_{IN} \leq -8.0V$	-	-	1.5	mA	
	ΔI_{BO}		$1.0mA \leq I_{OUT} \leq 40mA$	-	-	0.1		
Output Noise Voltage	V_{NO}	3	$T_a=25^{\circ}C$, $10Hz \leq f \leq 100kHz$	-	40	-	μV_{rms}	
Long Term Stability	$\Delta V_{OUT}/\Delta t$	1		-	12	-	mV/ 1.0kHrs	
Ripple Rejection Ratio	RR	2	$-18V \leq V_{IN} \leq -8.0V$, $T_j=25^{\circ}C$, $f=120Hz$	41	49	-	dB	
Dropout Voltage	$ V_{IN}-V_{OUT} $	1	$T_j=25^{\circ}C$, $I_{OUT}=40mA$	-	1.7	-	V	
Average Temperature Coefficient of Output Voltage	TC_{VO}	1	$I_{OUT}=5mA$	-	-0.6	-	mV/ $^{\circ}C$	

KIA79L05BP~KIA79L24BP

ELECTRICAL CHARACTERISTICS

KIA79L06BP

(Unless otherwise specified, $V_{IN}=-11V$, $I_{OUT}=40mA$, $C_{IN}=0.33\mu F$, $C_{OUT}=0.1\mu F$, $0^{\circ}C \leq T_j \leq 125^{\circ}C$)

CHARACTERISTIC	SYMBOL	TEST CIRCUIT	TEST CONDITION	MIN.	TYP.	MAX.	UNIT	
Output Voltage	V_{OUT}	1	$T_j=25^{\circ}C$	-6.24	-6.0	-5.76	V	
Input Regulation	Reg line	1	$T_j=25^{\circ}C$	$-21V \leq V_{IN} \leq -8.1V$	-	50	150	mV
				$-21V \leq V_{IN} \leq -9.0V$	-	45	110	
Load Regulation	Reg load	1	$T_j=25^{\circ}C$	$1.0mA \leq I_{OUT} \leq 100mA$	-	12	70	mV
				$1.0mA \leq I_{OUT} \leq 40mA$	-	5.5	35	
Output Voltage	V_{OUT}	1	$-21V \leq V_{IN} \leq -8.1V$ $1.0mA \leq I_{OUT} \leq 40mA$	-6.3	-	-5.7	V	
			$V_{IN}=-11V$, $1.0mA \leq I_{OUT} \leq 70mA$	-6.3	-	-5.7		
Quiescent Current	I_B	1	$T_j=25^{\circ}C$	-	3.1	6.0	mA	
			$T_j=125^{\circ}C$	-	-	5.5		
Quiescent Current Change	ΔI_{BI}	1	$-20V \leq V_{IN} \leq -9.0V$	-	-	1.5	mA	
	ΔI_{BO}		$1.0mA \leq I_{OUT} \leq 40mA$	-	-	0.1		
Output Noise Voltage	V_{NO}	3	$T_a=25^{\circ}C$, $10Hz \leq f \leq 100kHz$	-	40	-	μV_{rms}	
Long Term Stability	$\Delta V_{OUT} / \Delta t$	1		-	14	-	mV/ 1.0kHrs	
Ripple Rejection Ratio	RR	2	$-19V \leq V_{IN} \leq -9.0V$, $T_j=25^{\circ}C$, $f=120Hz$	39	47	-	dB	
Dropout Voltage	$ V_{IN} - V_{OUT} $	1	$T_j=25^{\circ}C$, $I_{OUT}=40mA$	-	1.7	-	V	
Average Temperature Coefficient of Output Voltage	TC_{VO}	1	$I_{OUT}=5mA$	-	-0.7	-	mV/ $^{\circ}C$	

KIA79L05BP~KIA79L24BP

ELECTRICAL CHARACTERISTICS

KIA79L08BP

(Unless otherwise specified, $V_{IN}=-14V$, $I_{OUT}=40mA$, $C_{IN}=0.33\mu F$, $C_{OUT}=0.1\mu F$, $0^\circ C \leq T_j \leq 125^\circ C$)

CHARACTERISTIC	SYMBOL	TEST CIRCUIT	TEST CONDITION	MIN.	TYP.	MAX.	UNIT	
Output Voltage	V_{OUT}	1	$T_j=25^\circ C$	-8.3	-8.0	-7.7	V	
Input Regulation	Reg line	1	$T_j=25^\circ C$	$-23V \leq V_{IN} \leq -10.5V$	-	20	175	mV
				$-23V \leq V_{IN} \leq -11V$	-	12	125	
Load Regulation	Reg load	1	$T_j=25^\circ C$	$1.0mA \leq I_{OUT} \leq 100mA$	-	15	80	mV
				$1.0mA \leq I_{OUT} \leq 40mA$	-	7.0	40	
Output Voltage	V_{OUT}	1	$-23V \leq V_{IN} \leq -10.5V$ $1.0mA \leq I_{OUT} \leq 40mA$	-8.4	-	-7.6	V	
			$V_{IN}=-14V$, $1.0mA \leq I_{OUT} \leq 70mA$	-8.4	-	-7.6		
Quiescent Current	I_B	1	$T_j=25^\circ C$	-	3.1	6.5	mA	
			$T_j=125^\circ C$	-	-	6.0		
Quiescent Current Change	ΔI_{BI}	1	$-23V \leq V_{IN} \leq -11V$	-	-	1.5	mA	
	ΔI_{BO}		$1.0mA \leq I_{OUT} \leq 40mA$	-	-	0.1		
Output Noise Voltage	V_{NO}	3	$T_a=25^\circ C$, $10Hz \leq f \leq 100kHz$	-	60	-	μV_{rms}	
Long Term Stability	$\Delta V_{OUT}/\Delta t$	1		-	20	-	mV/ 1.0kHrs	
Ripple Rejection Ratio	RR	2	$-23V \leq V_{IN} \leq -12V$, $T_j=25^\circ C$, $f=120Hz$	37	45	-	dB	
Dropout Voltage	$ V_{IN}-V_{OUT} $	1	$T_j=25^\circ C$, $I_{OUT}=40mA$	-	1.7	-	V	
Average Temperature Coefficient of Output Voltage	TC_{VO}	1	$I_{OUT}=5mA$	-	-0.8	-	mV/ $^\circ C$	

KIA79L05BP~KIA79L24BP

ELECTRICAL CHARACTERISTICS

KIA79L09BP

(Unless otherwise specified, $V_{IN}=-15V$, $I_{OUT}=40mA$, $C_{IN}=0.33\mu F$, $C_{OUT}=0.1\mu F$, $0^\circ C \leq T_j \leq 125^\circ C$)

CHARACTERISTIC	SYMBOL	TEST CIRCUIT	TEST CONDITION	MIN.	TYP.	MAX.	UNIT	
Output Voltage	V_{OUT}	1	$T_j=25^\circ C$	-9.36	-9.0	-8.64	V	
Input Regulation	Reg line	1	$T_j=25^\circ C$	$-24V \leq V_{IN} \leq -11.4V$	-	80	200	mV
				$-24V \leq V_{IN} \leq -12V$	-	20	160	
Load Regulation	Reg load	1	$T_j=25^\circ C$	$1.0mA \leq I_{OUT} \leq 100mA$	-	17	90	mV
				$1.0mA \leq I_{OUT} \leq 40mA$	-	8.0	45	
Output Voltage	V_{OUT}	1	$-24V \leq V_{IN} \leq -11.4V$ $1.0mA \leq I_{OUT} \leq 40mA$	-9.45	-	-8.55	V	
			$V_{IN}=-15V$, $1.0mA \leq I_{OUT} \leq 70mA$	-9.45	-	-8.55		
Quiescent Current	I_B	1	$T_j=25^\circ C$	-	3.2	6.5	mA	
			$T_j=125^\circ C$	-	-	6.0		
Quiescent Current Change	ΔI_{BI}	1	$-24V \leq V_{IN} \leq -12V$	-	-	1.5	mA	
	ΔI_{BO}		$1.0mA \leq I_{OUT} \leq 40mA$	-	-	0.1		
Output Noise Voltage	V_{NO}	3	$T_a=25^\circ C$, $10Hz \leq f \leq 100kHz$	-	65	-	μV_{rms}	
Long Term Stability	$\Delta V_{OUT}/\Delta t$	1		-	21	-	mV/ 1.0kHrs	
Ripple Rejection Ratio	RR	2	$-24V \leq V_{IN} \leq -12V$, $T_j=25^\circ C$, $f=120Hz$	36	44	-	dB	
Dropout Voltage	$ V_{IN}-V_{OUT} $	1	$T_j=25^\circ C$, $I_{OUT}=40mA$	-	1.7	-	V	
Average Temperature Coefficient of Output Voltage	TC_{VO}	1	$I_{OUT}=5mA$	-	-0.85	-	mV/ $^\circ C$	

KIA79L05BP~KIA79L24BP

ELECTRICAL CHARACTERISTICS

KIA79L10BP

(Unless otherwise specified, $V_{IN}=-16V$, $I_{OUT}=40mA$, $C_{IN}=0.33\mu F$, $C_{OUT}=0.1\mu F$, $0^{\circ}C \leq T_j \leq 125^{\circ}C$)

CHARACTERISTIC	SYMBOL	TEST CIRCUIT	TEST CONDITION	MIN.	TYP.	MAX.	UNIT	
Output Voltage	V_{OUT}	1	$T_j=25^{\circ}C$	-10.4	-10.0	-9.6	V	
Input Regulation	Reg line	1	$T_j=25^{\circ}C$	$-25V \leq V_{IN} \leq -12.5V$	-	80	230	mV
				$-25V \leq V_{IN} \leq -13V$	-	30	170	
Load Regulation	Reg load	1	$T_j=25^{\circ}C$	$1.0mA \leq I_{OUT} \leq 100mA$	-	18	90	mV
				$1.0mA \leq I_{OUT} \leq 40mA$	-	8.5	45	
Output Voltage	V_{OUT}	1	$-25V \leq V_{IN} \leq -12.5V$ $1.0mA \leq I_{OUT} \leq 40mA$	-10.5	-	-9.5	V	
			$V_{IN}=-16V$, $1.0mA \leq I_{OUT} \leq 70mA$	-10.5	-	-9.5		
Quiescent Current	I_B	1	$T_j=25^{\circ}C$	-	3.2	6.5	mA	
			$T_j=125^{\circ}C$	-	-	6.0		
Quiescent Current Change	ΔI_{BI}	1	$-25V \leq V_{IN} \leq -13V$	-	-	1.5	mA	
	ΔI_{BO}		$1.0mA \leq I_{OUT} \leq 40mA$	-	-	0.1		
Output Noise Voltage	V_{NO}	3	$T_a=25^{\circ}C$, $10Hz \leq f \leq 100kHz$	-	70	-	μV_{rms}	
Long Term Stability	$\Delta V_{OUT} / \Delta t$	1		-	22	-	mV/ 1.0kHrs	
Ripple Rejection Ratio	RR	2	$-24V \leq V_{IN} \leq -13V$, $T_j=25^{\circ}C$, $f=120Hz$	36	43	-	dB	
Dropout Voltage	$ V_{IN} - V_{OUT} $	1	$T_j=25^{\circ}C$, $I_{OUT}=40mA$	-	1.7	-	V	
Average Temperature Coefficient of Output Voltage	TC_{VO}	1	$I_{OUT}=5mA$	-	-0.9	-	mV/ $^{\circ}C$	

KIA79L05BP~KIA79L24BP

ELECTRICAL CHARACTERISTICS

KIA79L12BP

(Unless otherwise specified, $V_{IN}=-19V$, $I_{OUT}=40mA$, $C_{IN}=0.33\mu F$, $C_{OUT}=0.1\mu F$, $0^{\circ}C \leq T_j \leq 125^{\circ}C$)

CHARACTERISTIC	SYMBOL	TEST CIRCUIT	TEST CONDITION	MIN.	TYP.	MAX.	UNIT	
Output Voltage	V_{OUT}	1	$T_j=25^{\circ}C$	-12.5	-12.0	-11.5	V	
Input Regulation	Reg line	1	$T_j=25^{\circ}C$	$-27V \leq V_{IN} \leq -14.5V$	-	120	250	mV
				$-27V \leq V_{IN} \leq -16V$	-	100	200	
Load Regulation	Reg load	1	$T_j=25^{\circ}C$	$1.0mA \leq I_{OUT} \leq 100mA$	-	20	100	mV
				$1.0mA \leq I_{OUT} \leq 40mA$	-	10	50	
Output Voltage	V_{OUT}	1	$-27V \leq V_{IN} \leq -14.5V$ $1.0mA \leq I_{OUT} \leq 40mA$	-12.6	-	-11.4	V	
			$V_{IN}=-19V$, $1.0mA \leq I_{OUT} \leq 70mA$	-12.6	-	-11.4		
Quiescent Current	I_B	1	$T_j=25^{\circ}C$	-	3.2	6.5	mA	
			$T_j=125^{\circ}C$	-	-	6.0		
Quiescent Current Change	ΔI_{BI}	1	$-27V \leq V_{IN} \leq -16V$	-	-	1.5	mA	
	ΔI_{BO}		$1.0mA \leq I_{OUT} \leq 40mA$	-	-	0.1		
Output Noise Voltage	V_{NO}	3	$T_a=25^{\circ}C$, $10Hz \leq f \leq 100kHz$	-	80	-	μV_{rms}	
Long Term Stability	$\Delta V_{OUT}/\Delta t$	1		-	24	-	mV/ 1.0kHrs	
Ripple Rejection Ratio	RR	2	$-25V \leq V_{IN} \leq -15V$, $T_j=25^{\circ}C$, $f=120Hz$	37	42	-	dB	
Dropout Voltage	$ V_{IN}-V_{OUT} $	1	$T_j=25^{\circ}C$, $I_{OUT}=40mA$	-	1.7	-	V	
Average Temperature Coefficient of Output Voltage	TC_{VO}	1	$I_{OUT}=5mA$	-	-1.0	-	mV/ $^{\circ}C$	

KIA79L05BP~KIA79L24BP

ELECTRICAL CHARACTERISTICS

KIA79L15BP

(Unless otherwise specified, $V_{IN}=-23V$, $I_{OUT}=40mA$, $C_{IN}=0.33\mu F$, $C_{OUT}=0.1\mu F$, $0^{\circ}C \leq T_j \leq 125^{\circ}C$)

CHARACTERISTIC	SYMBOL	TEST CIRCUIT	TEST CONDITION	MIN.	TYP.	MAX.	UNIT	
Output Voltage	V_{OUT}	1	$T_j=25^{\circ}C$	-15.6	-15.0	-14.4	V	
Input Regulation	Reg line	1	$T_j=25^{\circ}C$	$-30V \leq V_{IN} \leq -17.5V$	-	130	300	mV
				$-30V \leq V_{IN} \leq -20V$	-	110	250	
Load Regulation	Reg load	1	$T_j=25^{\circ}C$	$1.0mA \leq I_{OUT} \leq 100mA$	-	25	150	mV
				$1.0mA \leq I_{OUT} \leq 40mA$	-	12	75	
Output Voltage	V_{OUT}	1	$-30V \leq V_{IN} \leq -17.5V$ $1.0mA \leq I_{OUT} \leq 40mA$	-15.75	-	-14.25	V	
			$V_{IN}=-23V$, $1.0mA \leq I_{OUT} \leq 70mA$	-15.75	-	-14.25		
Quiescent Current	I_B	1	$T_j=25^{\circ}C$	-	3.3	6.5	mA	
			$T_j=125^{\circ}C$	-	-	6.0		
Quiescent Current Change	ΔI_{BI}	1	$-30V \leq V_{IN} \leq -20V$	-	-	1.5	mA	
	ΔI_{BO}		$1.0mA \leq I_{OUT} \leq 40mA$	-	-	0.1		
Output Noise Voltage	V_{NO}	3	$T_a=25^{\circ}C$, $10Hz \leq f \leq 100kHz$	-	90	-	μV_{rms}	
Long Term Stability	$\Delta V_{OUT}/\Delta t$	1		-	30	-	mV/ 1.0kHrs	
Ripple Rejection Ratio	RR	2	$-28.5V \leq V_{IN} \leq -18.5V$, $T_j=25^{\circ}C$, $f=120Hz$	34	39	-	dB	
Dropout Voltage	$ V_{IN}-V_{OUT} $	1	$T_j=25^{\circ}C$, $I_{OUT}=40mA$	-	1.7	-	V	
Average Temperature Coefficient of Output Voltage	TC_{VO}	1	$I_{OUT}=5mA$	-	-1.3	-	mV/ $^{\circ}C$	

KIA79L05BP~KIA79L24BP

ELECTRICAL CHARACTERISTICS

KIA79L18BP

(Unless otherwise specified, $V_{IN}=-27V$, $I_{OUT}=40mA$, $C_{IN}=0.33\mu F$, $C_{OUT}=0.1\mu F$, $0^{\circ}C \leq T_j \leq 125^{\circ}C$)

CHARACTERISTIC	SYMBOL	TEST CIRCUIT	TEST CONDITION	MIN.	TYP.	MAX.	UNIT	
Output Voltage	V_{OUT}	1	$T_j=25^{\circ}C$	-18.7	-18.0	-17.3	V	
Input Regulation	Reg line	1	$T_j=25^{\circ}C$	$-33V \leq V_{IN} \leq -20.7V$	-	32	325	mV
				$-33V \leq V_{IN} \leq -21V$	-	27	275	
Load Regulation	Reg load	1	$T_j=25^{\circ}C$	$1.0mA \leq I_{OUT} \leq 100mA$	-	30	170	mV
				$1.0mA \leq I_{OUT} \leq 40mA$	-	15	75	
Output Voltage	V_{OUT}	1	$-33V \leq V_{IN} \leq -20.9V$ $1.0mA \leq I_{OUT} \leq 40mA$	-18.9	-	-17.1	V	
			$V_{IN}=-27V$, $1.0mA \leq I_{OUT} \leq 70mA$	-18.9	-	-17.1		
Quiescent Current	I_B	1	$T_j=25^{\circ}C$	-	3.3	6.5	mA	
			$T_j=125^{\circ}C$	-	-	6.0		
Quiescent Current Change	ΔI_{BI}	1	$-33V \leq V_{IN} \leq -21V$	-	-	1.5	mA	
	ΔI_{BO}		$1.0mA \leq I_{OUT} \leq 40mA$	-	-	0.1		
Output Noise Voltage	V_{NO}	3	$T_a=25^{\circ}C$, $10Hz \leq f \leq 100kHz$	-	150	-	μV_{rms}	
Long Term Stability	$\Delta V_{OUT}/\Delta t$	1		-	45	-	mV/ 1.0kHrs	
Ripple Rejection Ratio	RR	2	$-33V \leq V_{IN} \leq -23V$, $T_j=25^{\circ}C$, $f=120Hz$	33	48	-	dB	
Dropout Voltage	$ V_{IN}-V_{OUT} $	1	$T_j=25^{\circ}C$, $I_{OUT}=40mA$	-	1.7	-	V	
Average Temperature Coefficient of Output Voltage	TC_{VO}	1	$I_{OUT}=5mA$	-	-1.5	-	mV/ $^{\circ}C$	

KIA79L05BP~KIA79L24BP

ELECTRICAL CHARACTERISTICS

KIA79L20BP

(Unless otherwise specified, $V_{IN}=-29V$, $I_{OUT}=40mA$, $C_{IN}=0.33\mu F$, $C_{OUT}=0.1\mu F$, $0^{\circ}C \leq T_j \leq 125^{\circ}C$)

CHARACTERISTIC	SYMBOL	TEST CIRCUIT	TEST CONDITION	MIN.	TYP.	MAX.	UNIT	
Output Voltage	V_{OUT}	1	$T_j=25^{\circ}C$	-20.8	-20.0	-19.2	V	
Input Regulation	Reg line	1	$T_j=25^{\circ}C$	$-35V \leq V_{IN} \leq -23.5V$	-	33	330	mV
				$-35V \leq V_{IN} \leq -24V$	-	28	285	
Load Regulation	Reg load	1	$T_j=25^{\circ}C$	$1.0mA \leq I_{OUT} \leq 100mA$	-	33	180	mV
				$1.0mA \leq I_{OUT} \leq 40mA$	-	17	90	
Output Voltage	V_{OUT}	1	$-35V \leq V_{IN} \leq -23.5V$ $1.0mA \leq I_{OUT} \leq 40mA$	-21.0	-	-19.0	V	
			$V_{IN}=-29V$, $1.0mA \leq I_{OUT} \leq 70mA$	-21.0	-	-19.0		
Quiescent Current	I_B	1	$T_j=25^{\circ}C$	-	3.3	6.5	mA	
			$T_j=125^{\circ}C$	-	-	6.0		
Quiescent Current Change	ΔI_{BI}	1	$-35V \leq V_{IN} \leq -24V$	-	-	1.5	mA	
	ΔI_{BO}		$1.0mA \leq I_{OUT} \leq 40mA$	-	-	0.1		
Output Noise Voltage	V_{NO}	3	$T_a=25^{\circ}C$, $10Hz \leq f \leq 100kHz$	-	170	-	μV_{rms}	
Long Term Stability	$\Delta V_{OUT}/\Delta t$	1		-	49	-	mV/ 1.0kHrs	
Ripple Rejection Ratio	RR	2	$-35V \leq V_{IN} \leq -27V$, $T_j=25^{\circ}C$, $f=120Hz$	31	37	-	dB	
Dropout Voltage	$ V_{IN}-V_{OUT} $	1	$T_j=25^{\circ}C$, $I_{OUT}=40mA$	-	1.7	-	V	
Average Temperature Coefficient of Output Voltage	TC_{VO}	1	$I_{OUT}=5mA$	-	-1.7	-	mV/ $^{\circ}C$	

KIA79L05BP~KIA79L24BP

ELECTRICAL CHARACTERISTICS

KIA79L24BP

(Unless otherwise specified, $V_{IN}=-33V$, $I_{OUT}=40mA$, $C_{IN}=0.33\mu F$, $C_{OUT}=0.1\mu F$, $0^{\circ}C \leq T_j \leq 125^{\circ}C$)

CHARACTERISTIC	SYMBOL	TEST CIRCUIT	TEST CONDITION	MIN.	TYP.	MAX.	UNIT	
Output Voltage	V_{OUT}	1	$T_j=25^{\circ}C$	-25.0	-24.0	-23.0	V	
Input Regulation	Reg line	1	$T_j=25^{\circ}C$	$-38V \leq V_{IN} \leq -27V$	-	35	350	mV
				$-38V \leq V_{IN} \leq -28V$	-	30	300	
Load Regulation	Reg load	1	$T_j=25^{\circ}C$	$1.0mA \leq I_{OUT} \leq 100mA$	-	40	200	mV
				$1.0mA \leq I_{OUT} \leq 40mA$	-	20	100	
Output Voltage	V_{OUT}	1	$-38V \leq V_{IN} \leq -27V$ $1.0mA \leq I_{OUT} \leq 40mA$	-25.2	-	-22.8	V	
			$V_{IN}=-33V$, $1.0mA \leq I_{OUT} \leq 70mA$	-25.2	-	-22.8		
Quiescent Current	I_B	1	$T_j=25^{\circ}C$	-	3.5	6.5	mA	
			$T_j=125^{\circ}C$	-	-	6.0		
Quiescent Current Change	ΔI_{BI}	1	$-38V \leq V_{IN} \leq -28V$	-	-	1.5	mA	
	ΔI_{BO}		$1.0mA \leq I_{OUT} \leq 40mA$	-	-	0.1		
Output Noise Voltage	V_{NO}	3	$T_a=25^{\circ}C$, $10Hz \leq f \leq 100kHz$	-	200	-	μV_{rms}	
Long Term Stability	$\Delta V_{OUT}/\Delta t$	1		-	56	-	mV/ 1.0kHrs	
Ripple Rejection Ratio	RR	2	$-35V \leq V_{IN} \leq -29V$, $T_j=25^{\circ}C$, $f=120Hz$	31	47	-	dB	
Dropout Voltage	$ V_{IN}-V_{OUT} $	1	$T_j=25^{\circ}C$, $I_{OUT}=40mA$	-	1.7	-	V	
Average Temperature Coefficient of Output Voltage	TC_{VO}	1	$I_{OUT}=5mA$	-	-2.0	-	mV/ $^{\circ}C$	

KIA79L05BP~KIA79L24BP

TEST CIRCUIT 1

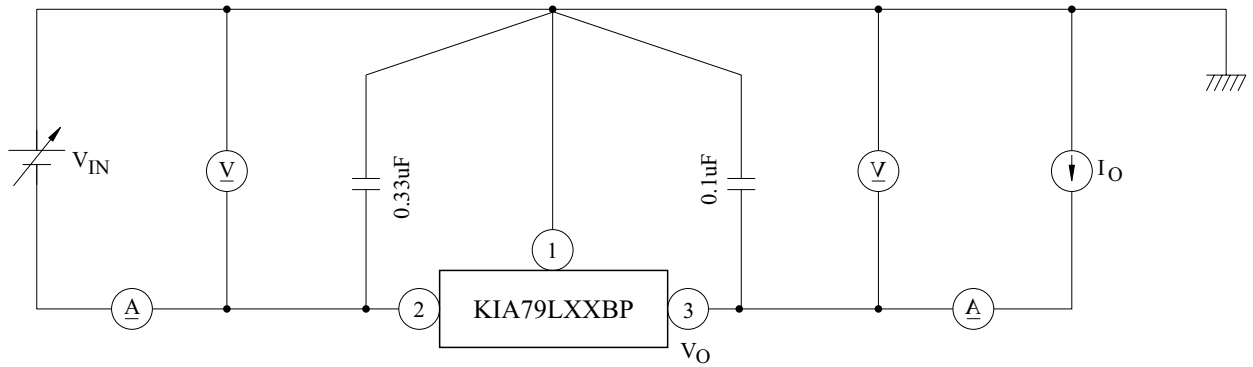

TEST CIRCUIT 2

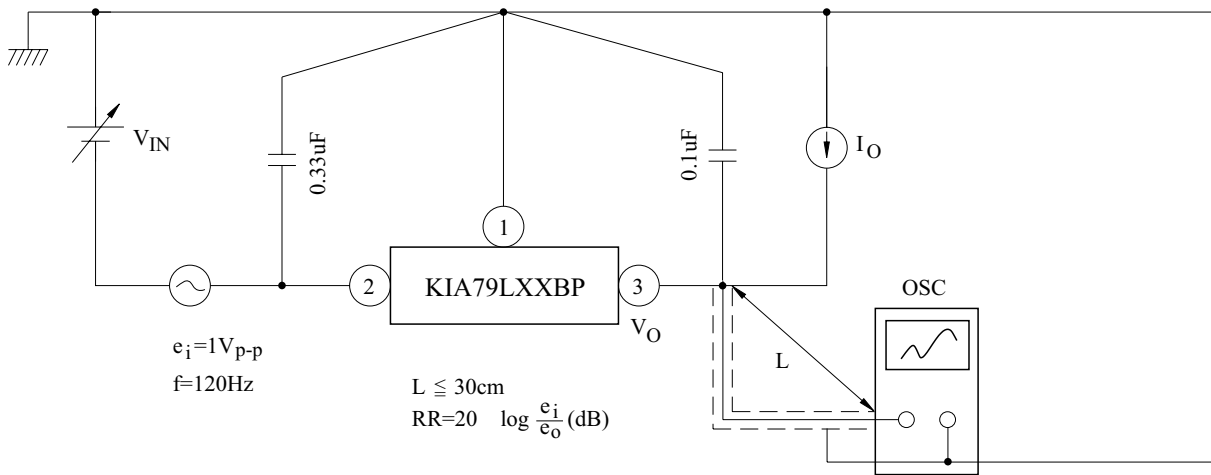

TEST CIRCUIT 3

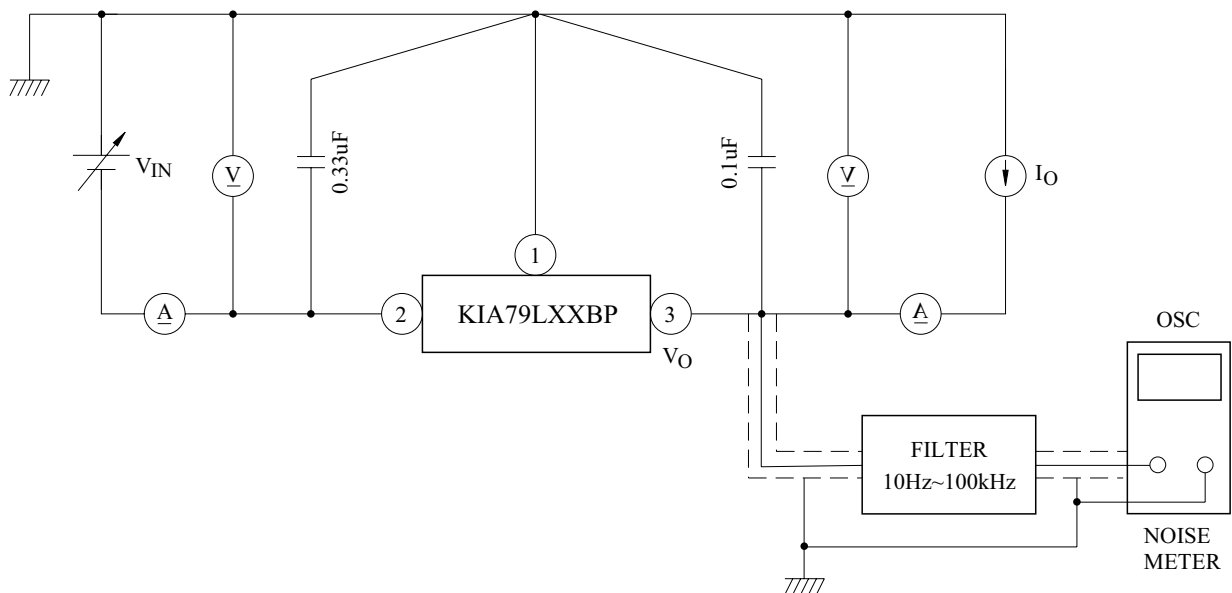

KIA79L05BP~KIA79L24BP

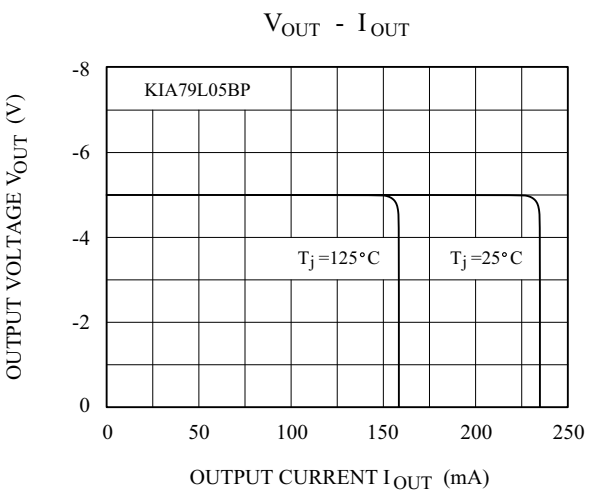
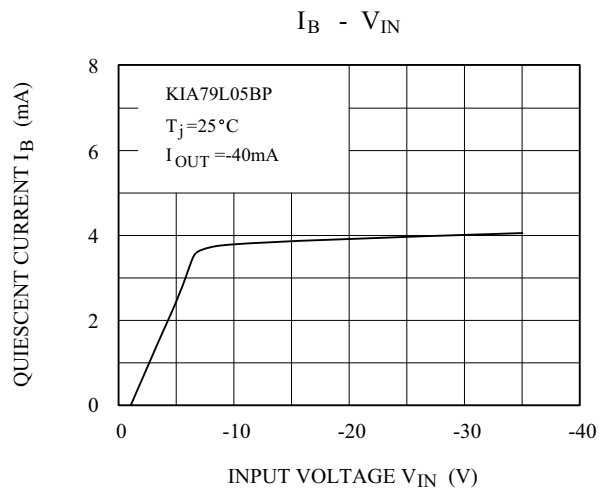
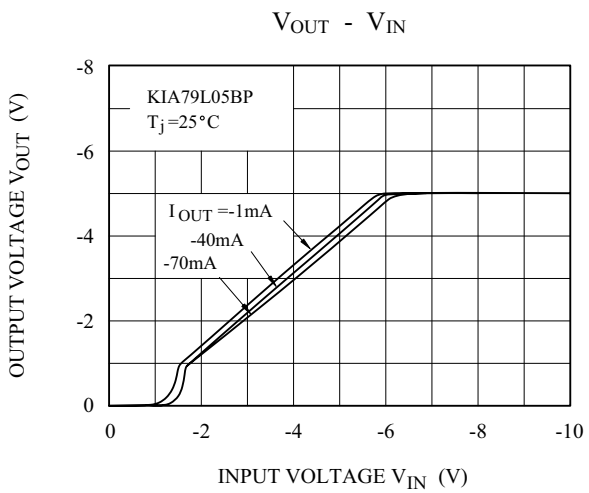
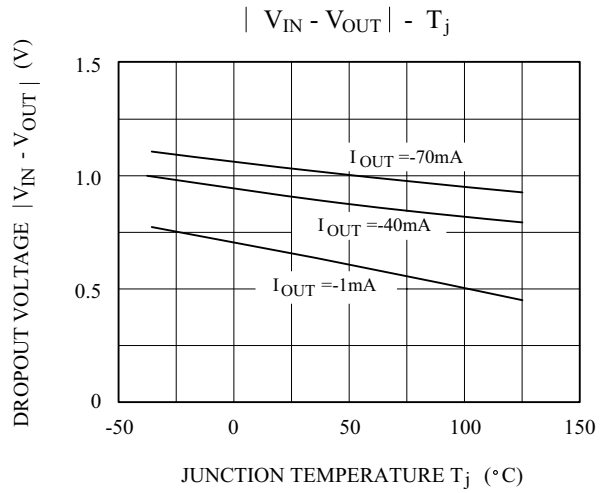
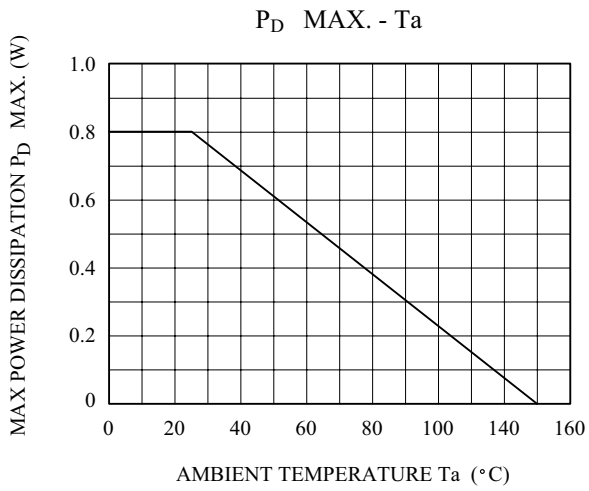

X-ON Electronics

Largest Supplier of Electrical and Electronic Components

Click to view similar products for [Linear Voltage Regulators](#) category:

Click to view products by [KEC](#) manufacturer:

Other Similar products are found below :

[LV56831P-E](#) [LV5684PVD-XH](#) [MCDTSA6-2R](#) [L7815ACV-DG](#) [PQ3DZ53U](#) [LV56801P-E](#) [TLE42794G](#) [L78L05CZ/1SX](#) [L78LR05DL-MA-E](#) [636416C](#) [714954EB](#) [BA033LBSG2-TR](#) [LV5680P-E](#) [L78M15CV-DG](#) [TLS202B1MBV33HTSA1](#) [L79M05T-E](#) [TLS202A1MBVHTSA1](#) [L78LR05D-MA-E](#) [NCV317MBTG](#) [NTE7227](#) [LV5680NPVC-XH](#) [LT1054CN8](#) [MP2018GZD-5-Z](#) [MP2018GZD-33-Z](#) [MIC5281-3.3YMM](#) [RT9078-28GQZ](#) [MC78L06BP-AP](#) [TA48LS05F\(TE85L,F\)](#) [TC47BR5003ECT](#) [TCR2LN12,LF\(S](#) [TCR2LN28,LF\(S](#) [TCR2LN30,LF\(S](#) [TCR3DF295,LM\(CT](#) [TCR3DF40,LM\(CT](#) [BA178M20CP-E2](#) [L78M12ABDT](#) [LR645N3-G-P003](#) [LR645N3-G-P013](#) [ZXTR2005P5-13](#) [SCD7812BTG](#) [TCR3DF335,LM\(CT](#) [TLE42994E V33](#) [ZXTR2008K-13](#) [ZXTR2005K-13](#) [L88R05DL-E](#) [ADP3300ARTZ-2.7RL7](#) [LM120K-15/883](#) [IFX54441LDVXUMA1](#) [LM317D2T-TR](#) [LM317K STEEL](#)