

SWITCHING APPLICATION.
INTERFACE CIRCUIT AND DRIVER CIRCUIT APPLICATION.

FEATURES

- With Built-in Bias Resistors.
- Simplify Circuit Design.
- Reduce a Quantity of Parts and Manufacturing Process.
- High Packing Density.
- Suffix U : Qualified to AEC-Q101.
ex) KRA301-RTK/HU
- Suffix A :USMI(1) Package.
ex) KRA301-RTK/PA

EQUIVALENT CIRCUIT

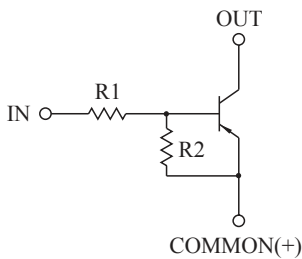

BIAS RESISTOR VALUES

TYPE NO.	R1(kΩ)	R2(kΩ)
KRA301	4.7	4.7
KRA302	10	10
KRA303	22	22
KRA304	47	47
KRA305	2.2	47
KRA306	4.7	47

MARK SPEC

TYPE	KRA301	KRA302	KRA303
MARK	PA	PB	PC
TYPE	KRA304	KRA305	KRA306
MARK	PD	PE	PF

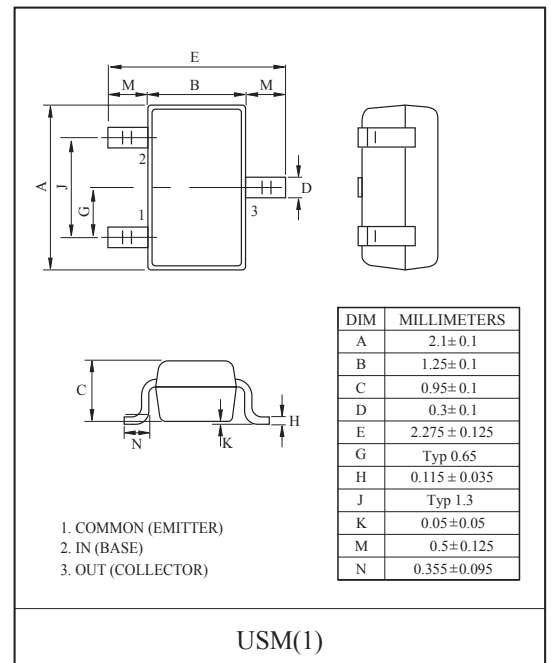
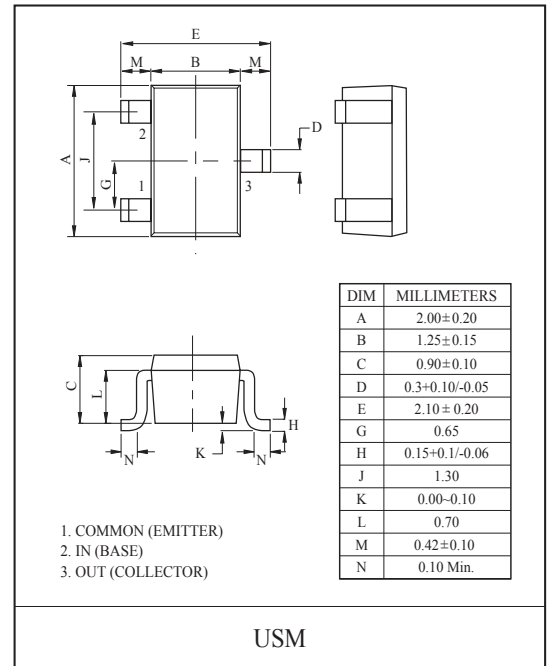
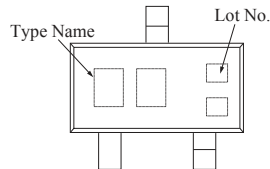

MAXIMUM RATING (Ta=25°C)

CHARACTERISTIC		SYMBOL	RATING	UNIT
Output Voltage	KRA301 ~ 306	V_O	-50	V
Input Voltage	KRA301	V_I	-20, 10	V
	KRA302		-30, 10	
	KRA303		-40, 10	
	KRA304		-40, 10	
	KRA305		-12, 5	
	KRA306		-20, 5	
Output Current	KRA301 ~ 306	I_O	-100	mA
Power Dissipation		P_D	100	mW
Junction Temperature		T_j	-55~150	°C
Storage Temperature Range		T_{stg}	-55~150	°C

KRA301~KRA306

ELECTRICAL CHARACTERISTICS (Ta=25°C)

CHARACTERISTIC		SYMBOL	TEST CONDITION	MIN.	TYP.	MAX.	UNIT
Output Cut-off Current	KRA301 ~ 306	$I_{O(OFF)}$	$V_O=-50V, V_I=0$	-	-	-500	nA
DC Current Gain	KRA301	G_I	$V_O=-5V, I_O=-10mA$	30	55	-	
	KRA302			50	80	-	
	KRA303			70	120	-	
	KRA304			80	200	-	
	KRA305			80	200	-	
	KRA306			80	200	-	
Output Voltage	KRA301 ~ 306	$V_{O(ON)}$	$I_O=-10mA, I_I=-0.5mA$	-	-0.1	-0.3	V
Input Voltage (ON)	KRA301	$V_{I(ON)}$	$V_O=-0.2V, I_O=-5mA$	-	-1.5	-2.0	V
	KRA302			-	-1.8	-2.4	
	KRA303			-	-2.1	-3.0	
	KRA304			-	-2.8	-5.0	
	KRA305			-	-0.8	-1.1	
	KRA306			-	-0.9	-1.3	
Input Voltage (OFF)	KRA301 ~ 304	$V_{I(OFF)}$	$V_O=-5V, I_O=-0.1mA$	-1.0	-1.2	-	V
	KRA305 ~ 306			-0.5	-0.65	-	
Transition Frequency	KRA301 ~ 306	f_T^*	$V_O=-10V, I_O=-5mA$	-	200	-	MHz
Input Current	KRA301	I_I	$V_I=-5V$	-	-	-1.8	mA
	KRA302			-	-	-0.88	
	KRA303			-	-	-0.36	
	KRA304			-	-	-0.18	
	KRA305			-	-	-3.6	
	KRA306			-	-	-1.8	
Input Resistor	KRA301	R1	-	3.29	4.7	6.11	kΩ
	KRA302			7	10	13	
	KRA303			15.4	22	28.6	
	KRA304			32.9	47	61.1	
	KRA305			1.54	2.2	2.86	
	KRA306			3.29	4.7	6.11	
Resistor Ratio	KRA301~304	R2/R1	-	0.8	1.0	1.2	
	KRA305			17	21	26	
	KRA306			8	10	12	

Note : * Characteristic of Transistor Only.

KRA301~KRA306

ELECTRICAL CHARACTERISTICS (Ta=25°C)

CHARACTERISTIC		SYMBOL	TEST CONDITION	MIN.	TYP.	MAX.	UNIT
Switching Time	Rise Time	KRA301	V _O =-5V V _{IN} =-5V R _L =1kΩ	-	0.07	-	μS
		KRA302		-	0.06	-	
		KRA303		-	0.2	-	
		KRA304		-	0.24	-	
		KRA305		-	0.02	-	
		KRA306		-	0.07	-	
	Storage Time	KRA301		-	1.1	-	
		KRA302		-	1.1	-	
		KRA303		-	1.1	-	
		KRA304		-	1.1	-	
		KRA305		-	1.1	-	
		KRA306		-	1.1	-	
	Fall Time	KRA301		-	0.15	-	
		KRA302		-	0.24	-	
		KRA303		-	0.38	-	
		KRA304		-	0.63	-	
		KRA305		-	0.1	-	
		KRA306		-	0.2	-	

KRA301~KRA306

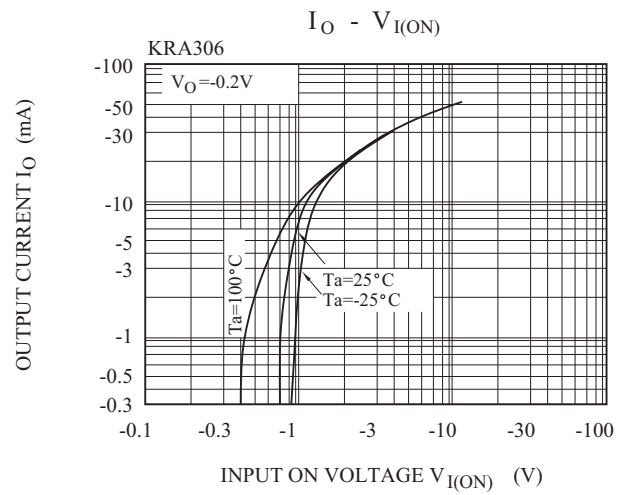
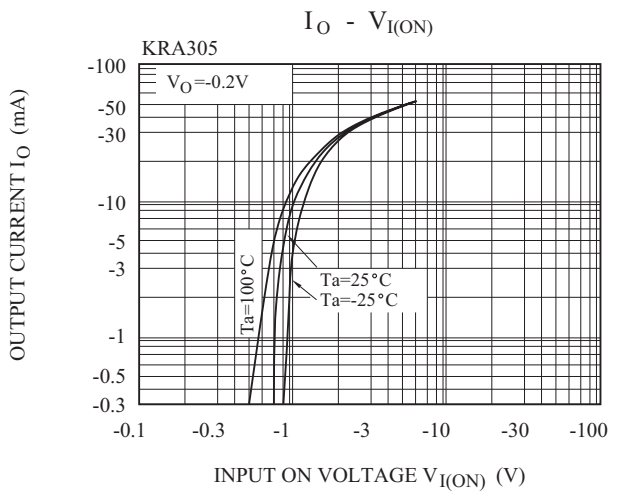
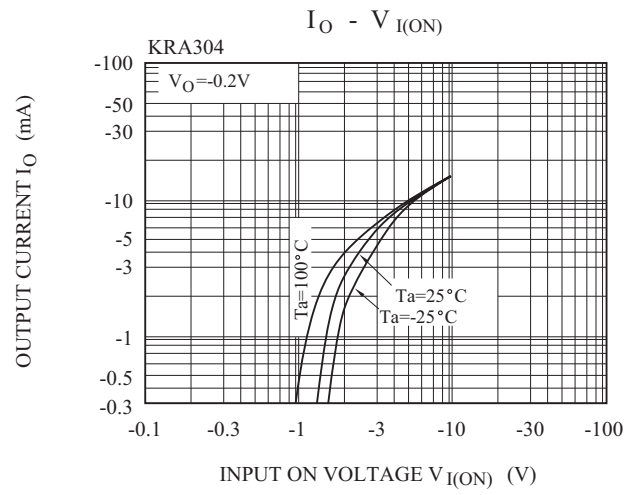
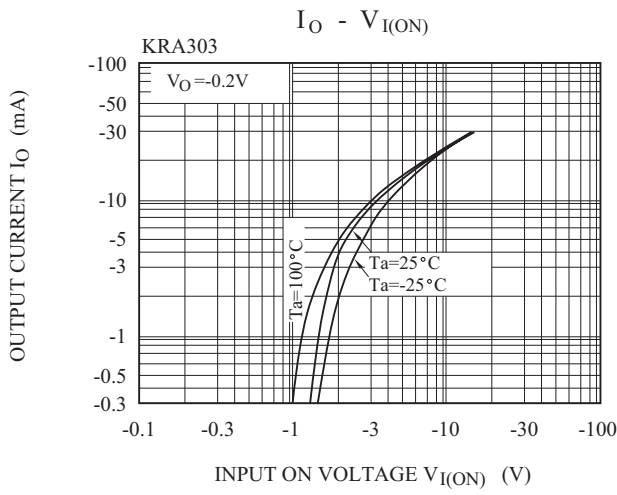
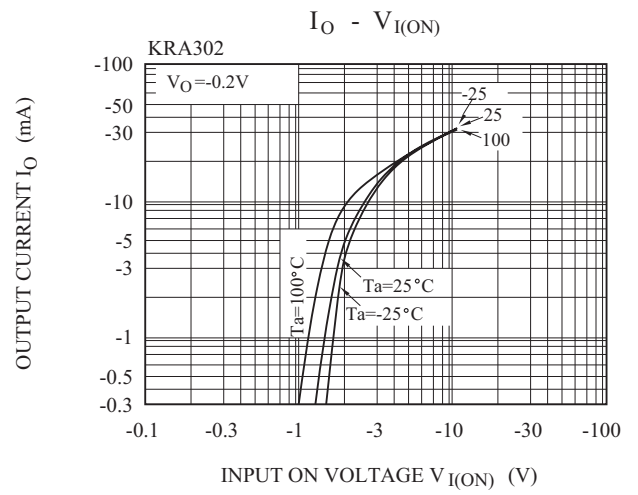
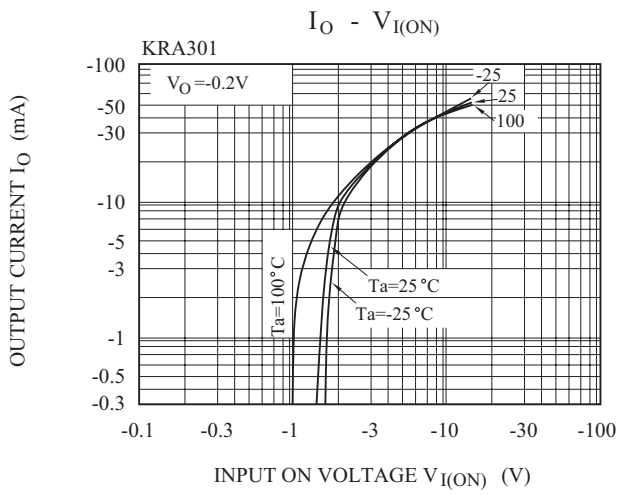

KRA301~KRA306

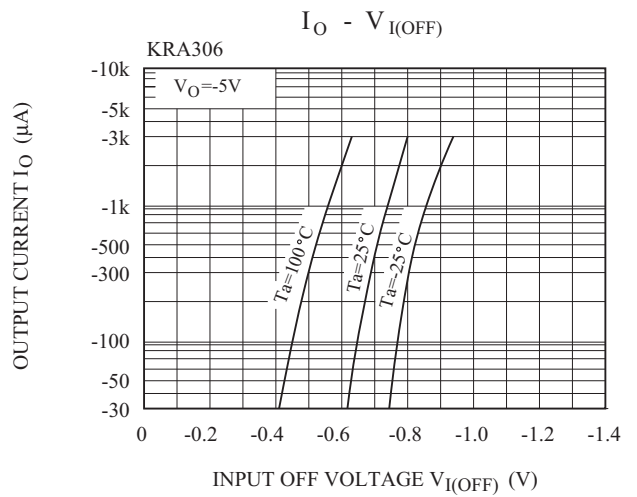
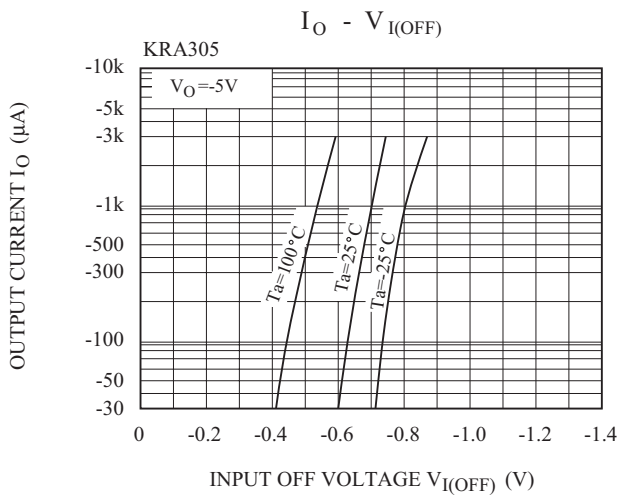
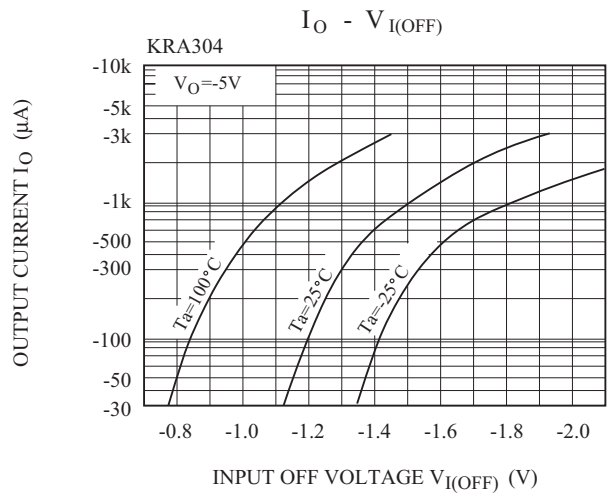
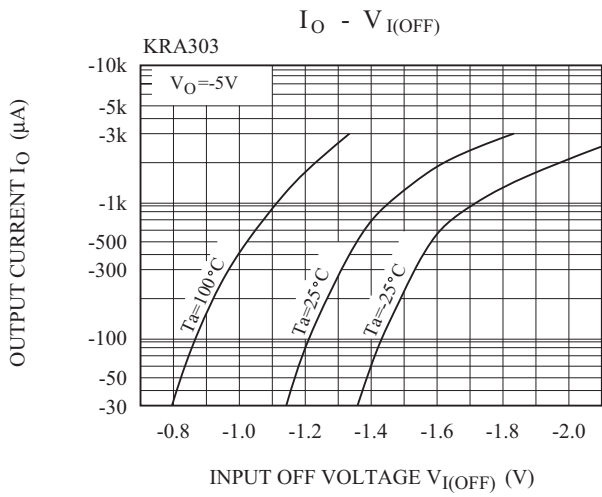
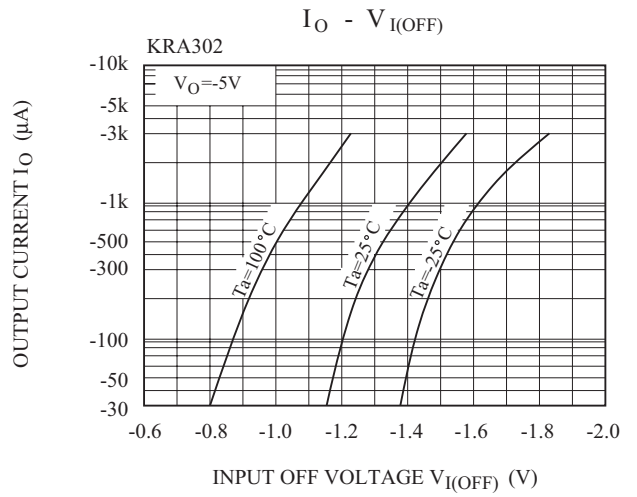
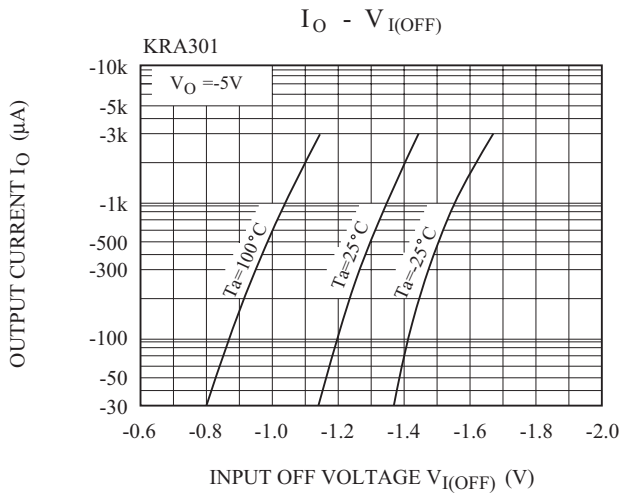

KRA301~KRA306

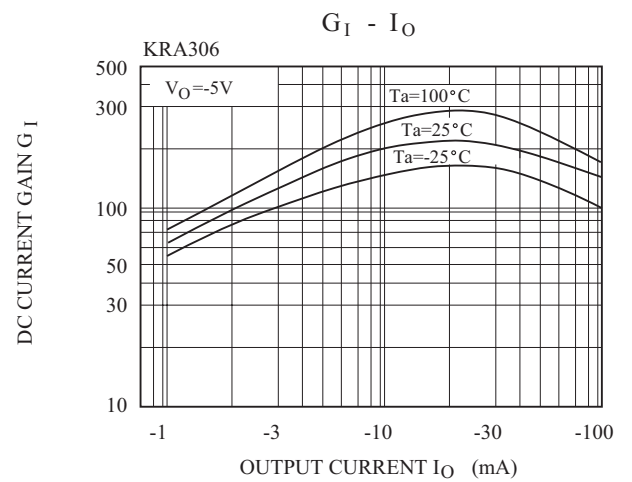
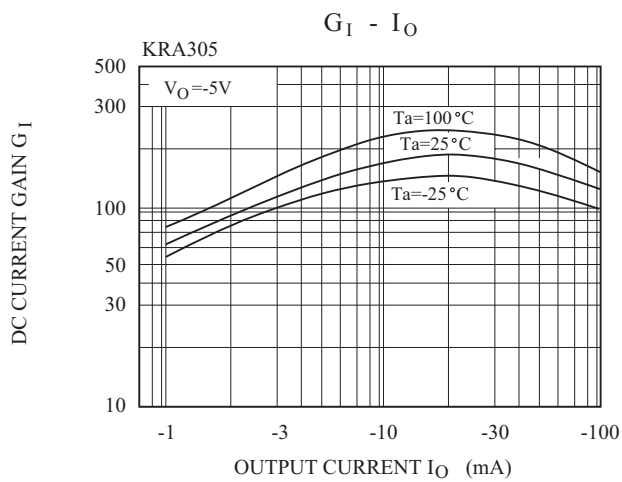
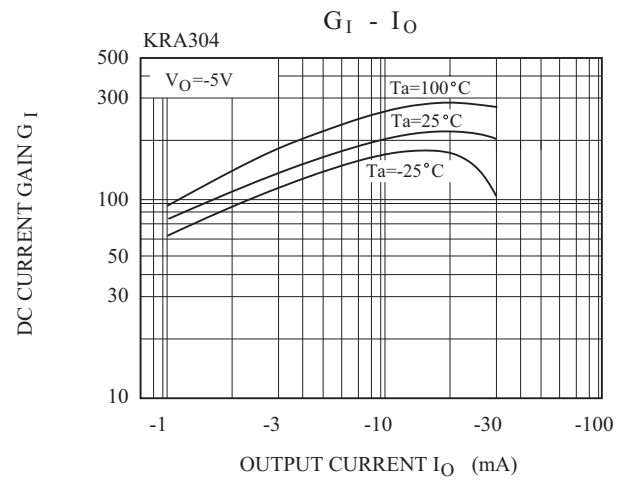
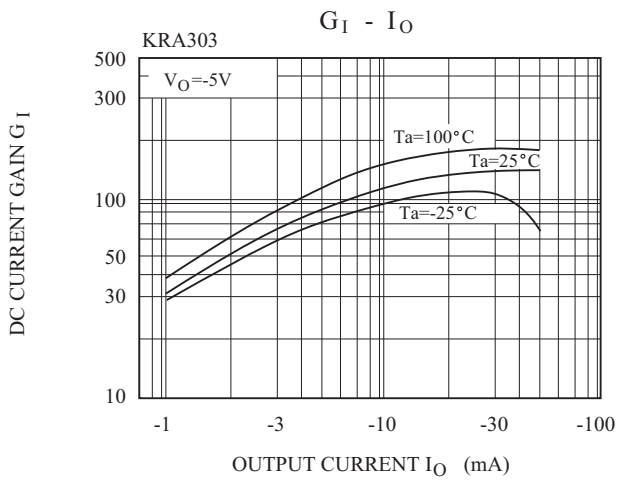
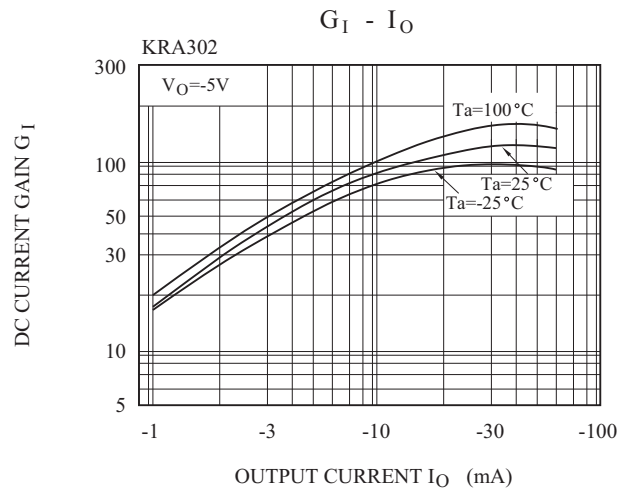
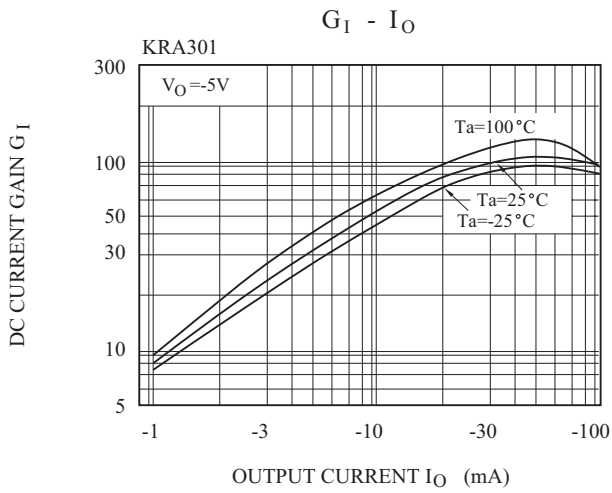

PRECAUTION ON USING KEC PRODUCTS

1. The products described in this data are intended to be used in general-purpose electronic equipment (Office equipment, telecommunication equipment, measuring equipment, home appliances)
2. When you intend to use these products with equipment or device which require an extremely high of reliability and special applications (such as automobile, air travel aerospace, transportation equipment, life support, system and safety devices) in which special quality and reliability and the failure or malfunction of products may directly jeopardize or harm the human body or damage to property and any application other than the standard application intended, please be sure to consult with our sales representative in advance.
3. On designing your application, please use product within the ranges guaranteed by KEC for maximum rating, operating supply voltage range, heat radiation characteristics and other characteristics. User shall be responsible for failure or damage when used beyond the guaranteed ranges.
4. The technical information described in this data is limited to showing representative characteristics and applied circuit examples of the products and it does not constitute the warranting of industrial property, the granting of relative rights, or the granting of any license.
5. What are described in the data may be changed without any prior notice to reflect new technical development. Please confirm that you have received the latest product standards or specification before final design, purchase or use.
6. Although KEC is continuously working to improve product reliability and quality, semiconductors can break down and malfunction due to various factors. Therefore, in order to prevent personal injury or fire arising from failure, please take safety measures such as complying with the derating characteristics, implementing redundant and fire prevention designs, and utilizing backups and fail-safe procedures. KEC shall have no responsibility for any damages arising out of the use of our Products beyond the rating specified by KEC.

X-ON Electronics

Largest Supplier of Electrical and Electronic Components

Click to view similar products for [Bipolar Transistors - BJT category](#):

Click to view products by [KEC manufacturer](#):

Other Similar products are found below :

[BC559C](#) [MCH4017-TL-H](#) [MMBT-2369-TR](#) [BC546/116](#) [NJVMJD148T4G](#) [NTE16](#) [NTE195A](#) [IMX9T110](#) [2N4401-A](#) [2N4403](#) [2N6728](#)
[2SA1419T-TD-H](#) [2SA2126-E](#) [2SB1204S-TL-E](#) [FMC5AT148](#) [2N2369ADCSM](#) [2N2907A](#) [2N3904-NS](#) [2N5769](#) [2SC4618TLN](#) [CPH6501-](#)
[TL-E](#) [MCH4021-TL-E](#) [Jantx2N5416](#) [US6T6TR](#) [BAX18/A52R](#) [BC556/112](#) [IMZ2AT108](#) [MMST8098T146](#) [UMX21NTR](#) [MCH6102-TL-E](#)
[TTA1452B,S4X\(S](#) [2N3879](#) [NTE13](#) [NTE282](#) [NTE323](#) [NTE350](#) [NTE81](#) [JANTX2N2920L](#) [JANTX2N3735](#) [JANSR2N2222AUB](#)
[CMLT3946EG TR](#) [SNSS40600CF8T1G](#) [CMLT3906EG TR](#) [GRP-DATA-JANS2N2907AUB](#) [GRP-DATA-JANS2N2222AUA](#)
[MMDT3946FL3-7](#) [2N4240](#) [MSB30KH-13](#) [2N2221AUB](#) [2SD1815T-TL-E](#)