



# HRS2H

SIGNAL RELAY

## ■ Safety Approval

 No. E164730

 No. 50097843

## ■ Features

- Microminiature relay  
Dimension: 20.3×9.9×11.4 (mm)
- High sensitivity
- 2 Form C contacts

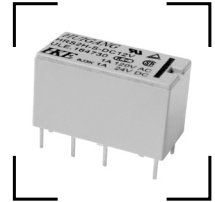

## ORDERING INFORMATION

**HRS2H** - **S** - **DC12V** - **T**

Model	Enclosure	Coil Voltage	Coil Sensitivity
	S - Plastic Sealed Type	DC3V, DC5V, DC6V DC9V, DC12V, DC24V	Blank: 450mW T - High Sensitivity (150mW) N - Sensitivity (200mW) B - Standard 360mW (48VDC: 400mW)

Remarks: 1. Available in 2 Form C only 2. Contact rating: 1A, 2A

## SPECIFICATION

### CONTACT DATA

Contact Form	2 Form C	
Contact Material	AuAg overlay, Ag Alloy	
Contact Rating	1A 120VAC/24VDC 2A 120VAC/24VDC	
Contact Resistance	Max. 50mΩ (6VDC 0.1A)	
Load	Max. Switching Voltage	125VAC/30VDC
	Max. Switching Current	2A
	Max. Switching Power	250VA, 60W
	Min. Switching Load	5VDC, 10mA
Life	Electrical	100,000 operations
	Mechanical	15,000,000 operations

### COIL DATA

Nominal Coil Power	150mW, 200mW, 360mW, 450mW
--------------------	----------------------------

### GENERAL DATA

Insulation Resistance	Min. 1000MΩ 500VDC	
Dielectric Strength	Between open contacts	500VAC, 1min
	Between coil and contacts	1,000VAC, 1min
Operate Time	Max. 7ms	
Release Time	Max. 3ms	
Operating Temperature	-25°C to +70°C	
Humidity	35~95%RH, +40°C	
Surge Strength	1,500VAC, 10x160 μs	
Shock Resistance	Endurance	1,000m/s <sup>2</sup>
	Misoperation	100m/s <sup>2</sup>
Vibration Resistance	Endurance	10~55Hz, 1.5mm double amplitude
	Misoperation	10~55Hz, 1.5mm double amplitude
Weight	Approximately 5.0g	

Note: Data shown are of initial value

## SAFETY APPROVAL

File Number	Contact Form	Power Consumption	Coil Voltage	Contact Rating	Remark
UL E164730	C	0.15W/0.20W/0.36W	3-48VDC	1A 120VAC/24VDC	Ambient Temperature: 85°C
				2A 120VAC/24VDC	
	C	0.45W	3-48VDC	1A 120VAC/24VDC	
TUV 50097843	C	0.20W/0.36W	3-24VDC	1A 120VAC/24VDC	Ambient Temperature: 70°C

Specifications subject to change without notice

ISO9001、ISO/TS16949、ISO14001 Approved

## COIL DATA

Ambient Temperature: 23°C

Model	Nominal Voltage VDC	Coil Resistance $\Omega$ +/-10%	Operate Voltage $\leq$ VDC	Release Voltage $\geq$ VDC	Coil Power mW
HRS2H-S-DC3V-N	3	45	2.25	0.3	200
HRS2H-S-DC5V-N	5	125	3.75	0.5	
HRS2H-S-DC6V-N	6	180	4.5	0.6	
HRS2H-S-DC9V-N	9	405	6.75	0.9	
HRS2H-S-DC12V-N	12	720	9.0	1.2	
HRS2H-S-DC24V-N	24	2880	18.0	2.4	
HRS2H-S-DC48V-N	48	11520	36.0	4.8	150
HRS2H-S-DC3V-T	3	60	2.25	0.3	
HRS2H-S-DC5V-T	5	166	3.75	0.5	
HRS2H-S-DC6V-T	6	240	4.5	0.6	
HRS2H-S-DC9V-T	9	540	6.75	0.9	
HRS2H-S-DC12V-T	12	960	9.0	1.2	
HRS2H-S-DC24V-T	24	3840	18.0	2.4	
HRS2H-S-DC48V-T	48	15360	36.0	4.8	360
HRS2H-S-DC3V-B	3	25	2.25	0.3	
HRS2H-S-DC5V-B	5	69.4	3.75	0.5	
HRS2H-S-DC6V-B	6	100	4.5	0.6	
HRS2H-S-DC9V-B	9	225	6.75	0.9	
HRS2H-S-DC12V-B	12	400	9.0	1.2	
HRS2H-S-DC24V-B	24	1600	18.0	2.4	
HRS2H-S-DC48V-B	48	5760	36.0	4.8	400
HRS2H-S-DC3V	3	20	2.25	0.3	450
HRS2H-S-DC5V	5	55.6	3.75	0.5	
HRS2H-S-DC6V	6	80	4.5	0.6	
HRS2H-S-DC9V	9	180	6.75	0.9	
HRS2H-S-DC12V	12	320	9.0	1.2	
HRS2H-S-DC24V	24	1280	18.0	2.4	
HRS2H-S-DC48V	48	5120	36.0	4.8	

## OUTLINE, WIRING DIAGRAM, MOUNTING HOLE LAYOUT (UNIT: mm)

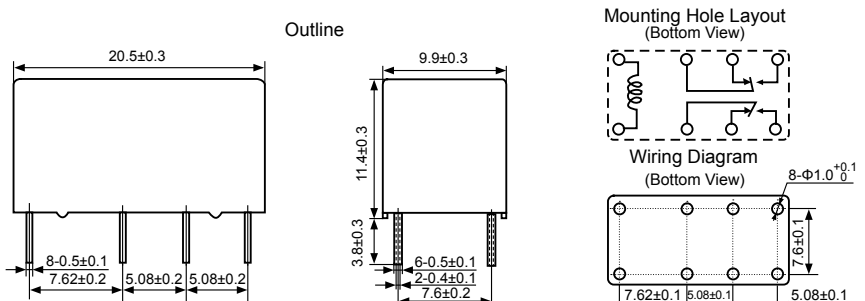



SIGNAL RELAY

## REFERENCE DATA

### Timing

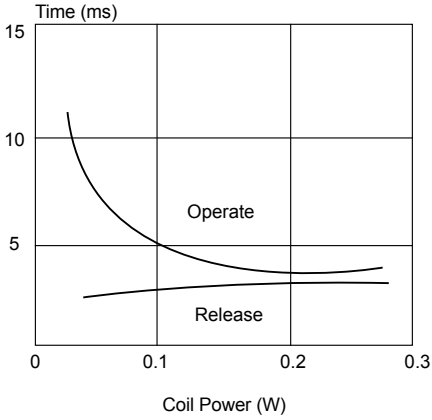

### Coil Temperature Rise

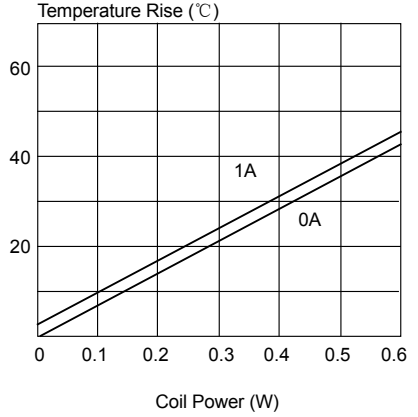

### Life Curves

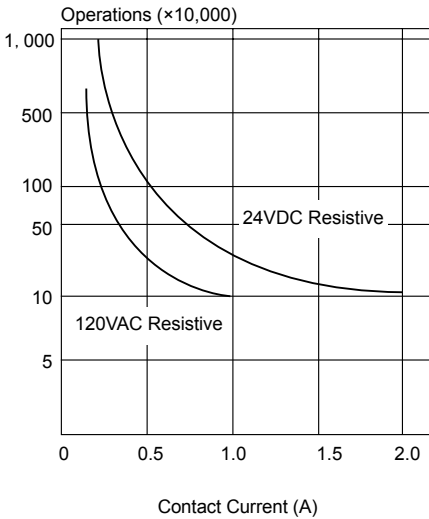

### Maximum Switching Power

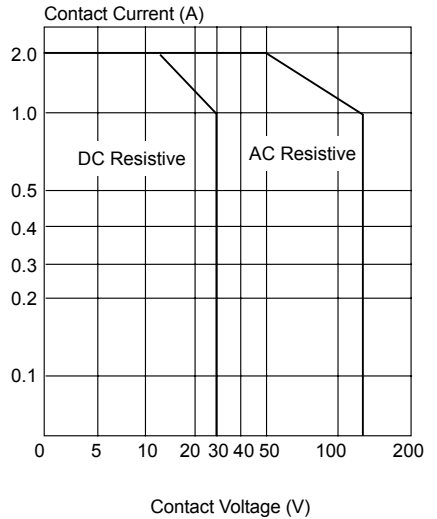

## X-ON Electronics

Largest Supplier of Electrical and Electronic Components

*Click to view similar products for [General Purpose Relays](#) category:*

*Click to view products by [Keke New Era](#) manufacturer:*

Other Similar products are found below :

[PCN-105D3MH,000](#) [59641F200](#) [5JO-1000CD-SIL](#) [5X827E](#) [5X837F](#) [5X840F](#) [5X842F](#) [5X848E](#) [LY2N-AC120](#) [LY2S-AC220/240](#) [LY2-US-AC120](#) [LY2-US-DC24](#) [LY3-US-AC120](#) [LY4F-UA-DC12](#) [LY4F-UA-DC24](#) [LY4F-US-AC120](#) [LY4F-US-AC240](#) [LY4F-US-DC24](#) [LY4F-VD-AC110](#) [LYQ20DC12](#) [M115C60](#) [M115N010](#) [M115N0150](#) [603-12D](#) [60HE1-5DC](#) [60HE2S-12DC](#) [61211T0B4](#) [61212T400](#) [61222Q400](#) [61243B600](#) [61243C500](#) [61243Q400](#) [61311BOA2](#) [61311BOA6](#) [61311BOA8](#) [61311C0A2](#) [61311COA1](#) [61311COA6](#) [61311F0A2](#) [61311QOA1](#) [61311QOA4](#) [61311T0D6](#) [61311TOA6](#) [61311TOA7](#) [61311TOB3](#) [61311TOB4](#) [61311U0A6](#) [61312Q600](#) [61312T400](#) [61312T600](#)