



常州市凯丽金电子有限公司---微型贴片电声元器件专业生产商



KELIKING ELECTRONIC-----Micro SMD Buzzer Professional manufacturer

SPECIFICATION FOR APPROVAL

承 認 書

Description : SMD Buzzer

Part No : KLJ-4020

Customer's Model No :

Specification No : KLJ-4020

Number Of The Edidion : 3.1

CUSTOMER'S APPROVED SIGNATURE		



常州市凯丽金电子有限公司 CHANGZHOU KELIKING ELECTRONICS CO., LTD
 公司地址: 常州市天宁区恒生科技园 1-1301, Company ADD: Hengsheng1-1301 Science Park, Tianning District, Changzhou City
 工厂地址: 常州市天宁区三河口东塘路 1-1 号, Factory: Dongtang Road NO. 1-1 sanhekou Tianning District Changzhou City
 电话: 86-519-88671999-801, Tel: 86-519-88671999-801 传真: 86-519-88671999-808, Fax: 86-519-88671999-808
 网址: www.kailijin.cn www.keliking.com Http:www.kailijin.cn www.keliking.com 邮箱: jimmy@keliking.com
 E-mail:jimmy@keliking.com 手机: 13656128000 MOB:13656128000

Approved by	Checked by	Lssued by



A.SCOPE 範疇



This specification applies magnetic buzzer.KLJ-4020

B.SPECIFICATION 规格

NO.	Item	Unit	Specification	Condition
1	Rated Voltage 額定電壓	Vo-p	3.0	
2	Operating Volt 操作電壓	Vo-p	2.0~4.0	
3	Mean Current 平均耗電流	mA	Max. 100	Applying rated voltage. 4000HZ squar wave. 1/2duty 施以額定電壓.4000HZ.方波.50%負載
4	Coil Resistance 直流阻抗	Ω	12 \pm 3	
5	Sound Output 輸出音壓	dBa	Min.73	Distance at 10cm (A-weight). Applying rated voltage 4000HZ.square wave.1/2duty 在 10cm 處, 施以額定電壓。4000HZ.方波.50%負載
6	Rated Frequency 額定頻率	HZ	4000	
7	Operating Temp 操作溫度	$^{\circ}$ C	-30 ~+70	
8	Storage Temp 儲存溫度	$^{\circ}$ C	-40 ~+80	
9	Dimension 尺寸	mm	L4×W4×H2	See attached drawing. 請參照外觀尺寸圖
10	Weight 重量	gram	0.4	
11	Material 材質		L.C.P (Black)	
12	Terminal 端子		SMD type (鍍全錫/Plating Sn)	See attached drawing. 請參照外觀尺寸圖
13	Environmental Protection Regulation 環保法規		RoHS	
14	Storage life 保存期限	month	6	6 months preservation at room temp.(25 \pm 3 $^{\circ}$ C). Humidity30% 在室溫下 25 \pm 3 $^{\circ}$ C. 濕度 30%以下可保存 6 個月



常州市凯丽金电子有限公司---微型贴片电声元器件专业生产商

KELIKING ELECTRONIC-----Micro SMD Buzzer Professional manufacturer

C.TYPICAL FREQUENCY RESPONSE CURVE 频率響應曲線

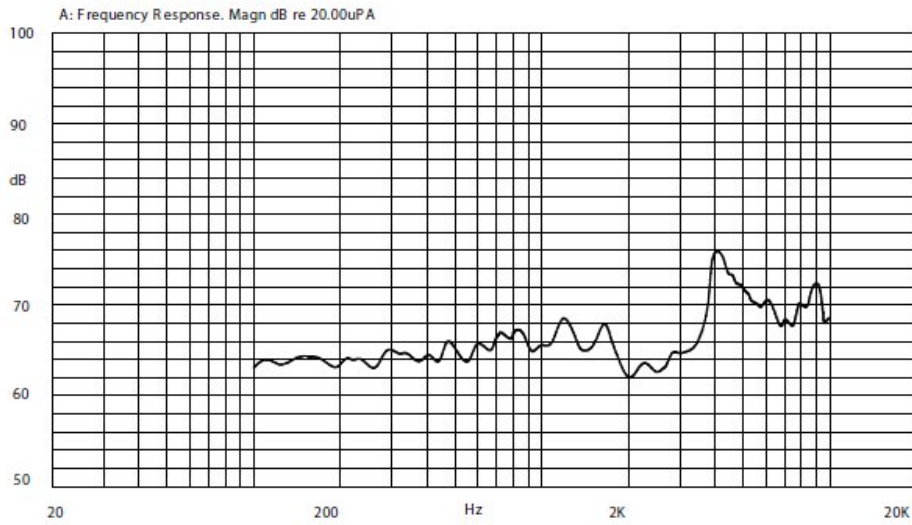

D.APPEARANCE DRAWING 外觀尺寸圖

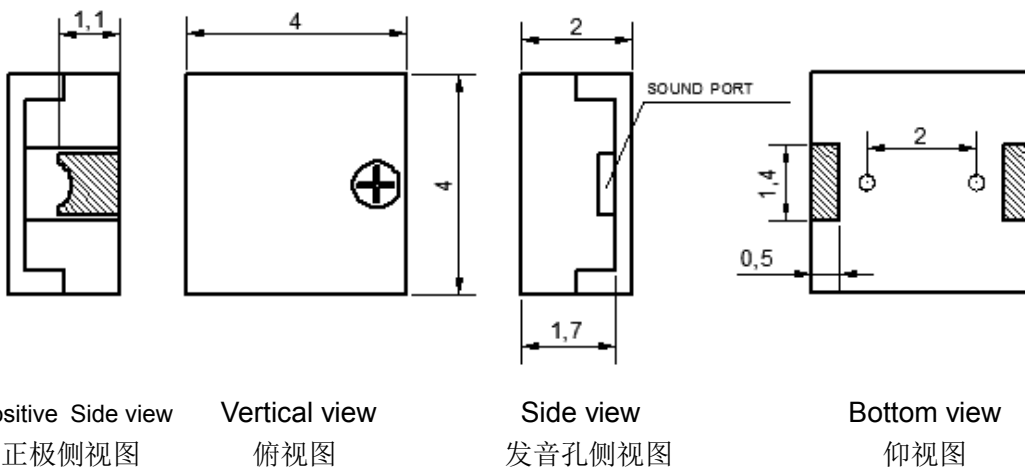

Tol:±0.3

Unit:mm

E.MEASUREMENT METHOD 測量方式

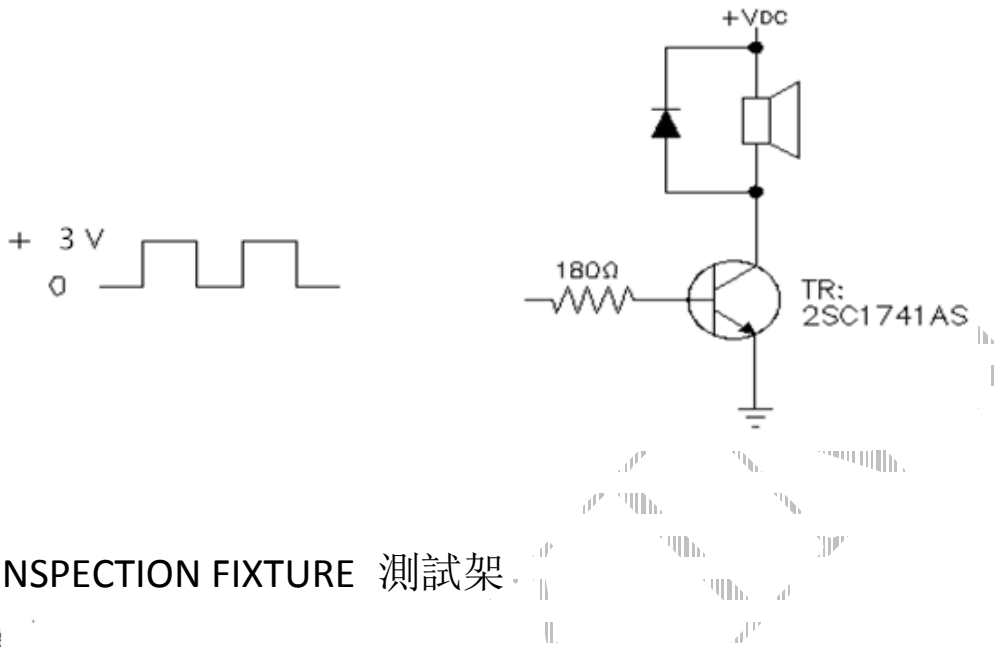

F.INSPECTION FIXTURE 測試架

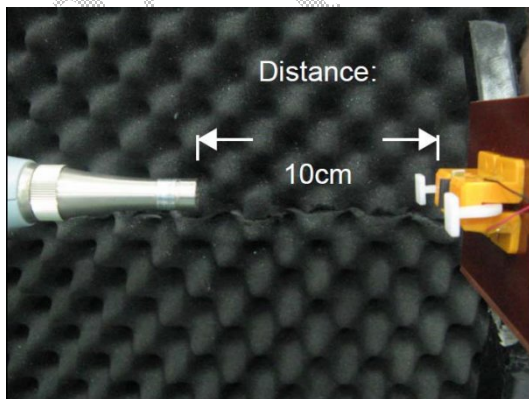
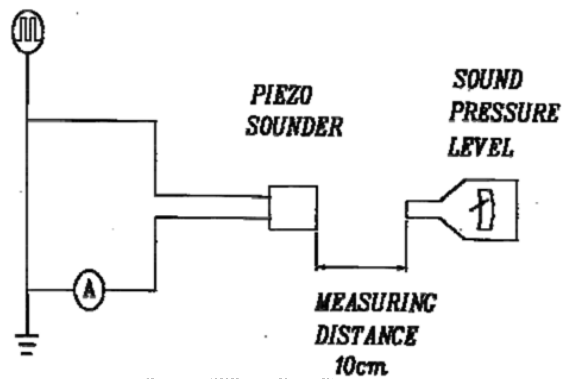



G.MECHANICAL CHARACTERISTICS 機械特性

NO.	Item	Test condition	Evaluation standard
1	Solderability 焊錫附著性	Lead terminals are immersed in solder bath of +260±5°C for 3±1 Second. 端子置於錫膏內, 錫膏溫度: +260±5°C. 焊接時間: 3±1 秒	95% surface of lead pads must be covered with fresh solder 錫膏需覆蓋端子上方 95%
2	Soldering Heat Resistance 焊錫耐熱性	The product is followed the reflow temperature curve to test its reflow thermostability 產品依照迴焊溫度曲線測試迴焊耐熱性	No interference in operation 操作上无任何不良
3	Terminal Mechanical Strength 端子強度	Lead pads shall be soldered on the pc board.and the force 9.8N (1.0kg) shall be applied behind the part for 10 seconds 將端子焊在 PC 板上后, 對單體施以 9.8N (1.0kg) 拉力 10 秒	No damage and cutting of 端子不松动, 不脫落
4	Vibration 震動測試	Buzzer shall be measured after being applied vibration of amplitude of 1.5mm with 10 to 55hz band of vibration frequency to each of 3per-pendicular directions for 6 hours 震動週波數 10~55HZ.全振幅 1.5mm 于 X.Y.Z 3 個方向.各 6 小時	After the test the part shall meet specifications With-out any damage in appearance and the SPL Should be in±10dBA compared with initial one 經测试后, 单体除音壓外觀及电气特性須符合规格, 輸出音壓变化量須±10dBA 內
5	Drop test 落下測試	The part only shall be dropped from a height of 75cm onto a 40mm thick wooden board 3 times in 3 axes(X.Y.Z).(a total of 9 times). 單體從 75 公分高處.X.Y.Z. 3 個方向.各 3 回.落于 40mm 厚木板上.	

H.ENVIRONMENT TEST 环境测试

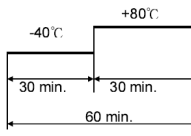
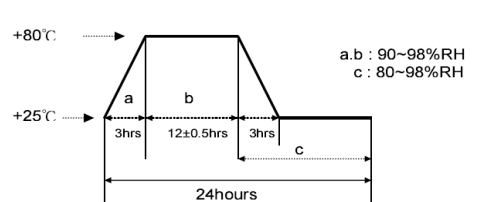
NO.	Item	Test condition	Evaluation standard
1	High temp test 高温测试	After being placed in a chamber at +80°C for 48 hours. 置于+80°C 环境中 48 小时	After the test the part shall meet specifications with-out any degradation in appearance and performance except SPL. After 4 hours at +25°C. the SPL should be in±10dBA compared with initial one 經测试后, 静置于+25°C (室温) 环境中 4 小时, 单体除音壓外, 外觀及电气特性須符合规格, 輸出音壓变化量需在±10dBA 內
2	Low temp test 低温测试	After being placed in a chamber at -40°C for 48 hours. 置于-40°C 环境中 48 小时	
3	Therman Shock 热冲击实验	The part shall be subjected to 10 cycles.One cycle shall consist of: 对单体施以热冲击实验 10 次循环.其循环内容如图示 	
4	Temp./Humidity Cycle 温度/湿度循环测试	The part shall be subjected to 10 cycles. One cycle shall be 24 hours and consist of 单体承受温度/湿度循环测试 10 次.其循环内容如图示 	

I.RELIABILITY TEST 信赖性测试

No.	Item	Test condition	Evaluation standard
1	Operating life test 寿命测试	<p>1. Ordinary temperature 室温寿命测试 The part shall be subjected to 100 hours at room temperature with 3.0V.4000HZ applied (+25±10℃)下, 输入 3.0V. 4000HZ 连续操作 100 小时</p> <p>2. High temperature 高温寿命测试 The part shall be subjected to 50 hours at +55℃ with 3.0V. 4000HZ applied 在+55℃环境下, 输入 3.0V. 4000HZ 连续操作 50 小时</p> <p>3. Low temperature 低温寿命测试 The part shall be subjected to 50 hours at -30℃ with 3.0V. 4000HZ applied 在-30℃环境下, 输入 3.0V. 4000HZ 连续操作 50 小时</p>	<p>After the test the part shall meet Specifications with-out any degradation in appearance and Performance except. SPL. after 4 hours at +25℃. the SPL. should be in ±10dBA compared with initial one.</p> <p>经测试后, 静置于+25℃(室温)环境中 4 小时后, 单体除音壓外, 外觀及电气特性须符合规格, 輸出音壓变化量需在±10dBA 内</p>

TEST CONDITION.

Standard Test Condition : a) Temperature:+5~+35℃ b) Humidity:45-85% c) Pressure:860-1060mbar

一般测试条件 : a) 温度: +5~+35℃ b) 湿度:45-85% c) 气压: 860-1060mbar

Judament Test Condition: a) Temperature:+25±2℃ b) Humidity:60-70% c) Pressure:860-1060mbar

爭議时测试条件 : a) 温度: +25±2℃ b) 湿度: 60-70% c) 气压: 860-1060mbar

J.Recommended Temperature Profile For Reflow Oven 建議回焊爐溫度曲线 焊接区温度设置在 245 度左右

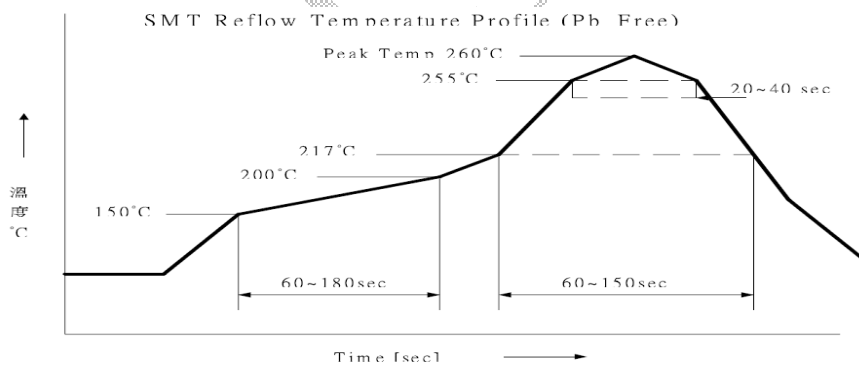

K.Recommended land pattern 建議基板設計尺寸圖

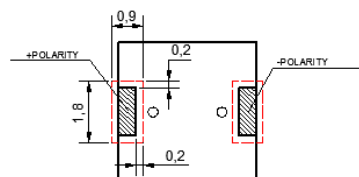

PIN package Vertical view, Connection between positive electrode of PIN package and positive electrode of product

此图为 PCB 板封装俯视图, PCB 封装的正负极和产品的正负极相对应

L.PACKING STANDARD 包装规格

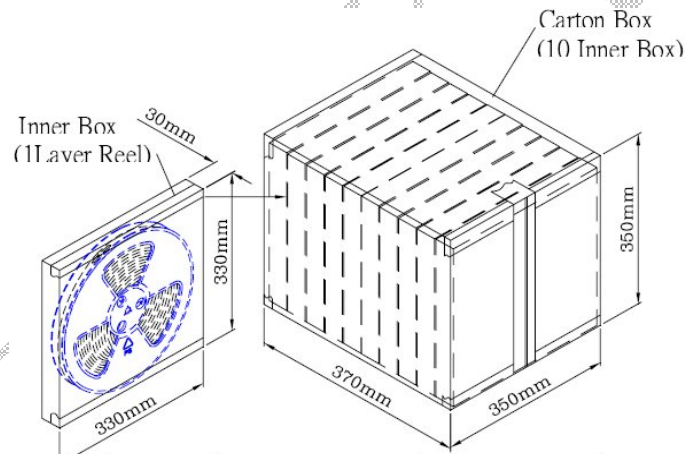
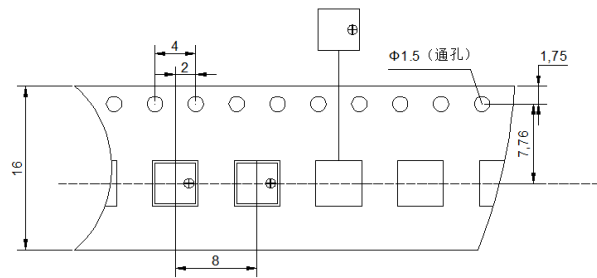
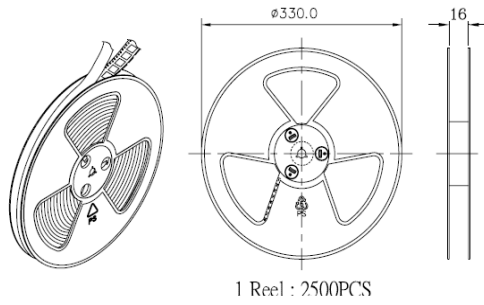

Inner Box	330mmx330mmx30mm	1x2500PCS=2500PCS
Carton Box	350mmx350mmx370mm	10x2500PCS=25,000PCS

X-ON Electronics

Largest Supplier of Electrical and Electronic Components

Click to view similar products for [Audio Indicators & Alerts](#) category:

Click to view products by [KELIKING](#) manufacturer:

Other Similar products are found below :

[M2BJ-BH24E](#) [6-4](#) [68S1240-PA](#) [MBA-624](#) [F/BC 40P-DR LF](#) [FDG111PLF](#) [F/NRMB 24 BLACK LF](#) [PF-35N29WQ](#) [PFD-27A35PQ](#) [PL-27A35PSQ](#) [PS-531Q](#) [AB2020B-2-LW1](#) [EBPT-401](#) [PB06SD12AP](#) [PB-1220PEQ](#) [S6109](#) [SC2036ACP](#) [SC616N-2](#) [SC628FW](#) [SC628MPG](#) [SC648D](#) [SCS045MD9DT3S](#) [AB2025B-LW50-R](#) [ESZ-25B-5-250B](#) [F/BC 35-DR LF](#) [FCM12PLF](#) [F/EB20P-DR LF](#) [F/HU110MP24V-IP67B LF](#) [AI-2835-TF-LW150-2-R](#) [AI-4228-TF-LW305-R](#) [FSMD8585JSLF](#) [FSS-26T](#) [F/SU 21-02 LF](#) [F/TCW 05 WITH LABEL LF](#) [F/UCW 03 WITH LABEL LF](#) [F/UCW 06 WITH LABEL LF](#) [PKM22EPPH40S1-B0](#) [PKM35-4A0](#) [PL-35N29WQ](#) [PLD-27A35PQ](#) [PS-552Q](#) [CM-5](#) [M2BJ-BH24E-D](#) [REF-202](#) [LSC628ANR](#) [5-100](#) [PAL-328](#) [03-810.001](#) [RTO-1R07-001](#) [PL-21N31PQ](#) [PF-27A25PSQ](#)