

C4AQ-P, Radial, 2 or 4 Leads, 450 – 1,100 VDC, for DC Link (Automotive Grade) - 125°C with Long Life

Overview

The C4AQ-P capacitor is a polypropylene metallized film capacitor with a rectangular, plastic box-type design filled with resin, and uses 2 or 4 tinned wires.

Automotive grade devices meet the demanding Automotive Electronics Council's AEC-Q200 qualification requirements with longer life performances at 125°C.

Applications

Typical applications include DC filtering, DC link, power electronics, energy storage, renewable energy grid interface, motor drives, and automotive applications.

Benefits

- Long life at 125°C
- Self-healing
- Low loss
- Low ESL
- Low profile dimensions available
- High ripple current
- High dV/dt
- High capacitance density
- High contact reliability
- Suitable for high frequency applications
- Automotive Grades (AEC-Q200)

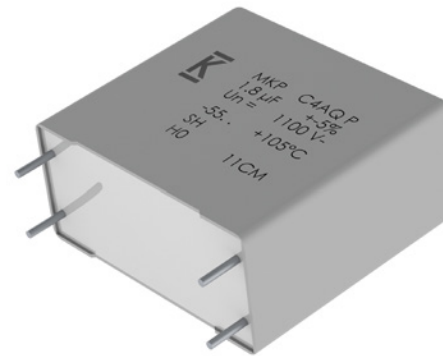

Part Number System

| C4 | A | Q | Q | B | W | 5270 | P | 3 | N | J |
|---------------------------|-------------------------|------------------------------|---|--|--------------------------|---|------------------------------------|-------------------------------|---|-------------------|
| Series | Type | Application | Rated Voltage (VDC) | Case | Terminals Code | Capacitance Code (pF) | Release | Lead Diameter (mm) | Size Code: B x H x L (mm) | Tolerance |
| C4 = MKP power capacitors | A = Box, wire terminals | Q = DC link Automotive Grade | G = 450 H = 600 J = 700 O = 900 Q = 1,100 | B, E = Box plastic case L = Low Profile box, plastic case | U = 2 pins W = 4 pins | Digits 2 – 4 indicate the first three digits of the capacitance value. First digit indicates the number of zeros to be added. | P = Long performance life at 125°C | 1 = 0.8 2 = 1.0 3 = 1.2 | See dimensions table below for valid case sizes | J = 5% K = 10% |

Series Selection

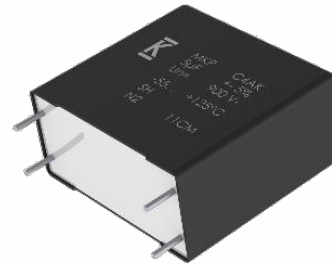

**DC-LINK, DC FILTER
 TREE FAMILY**

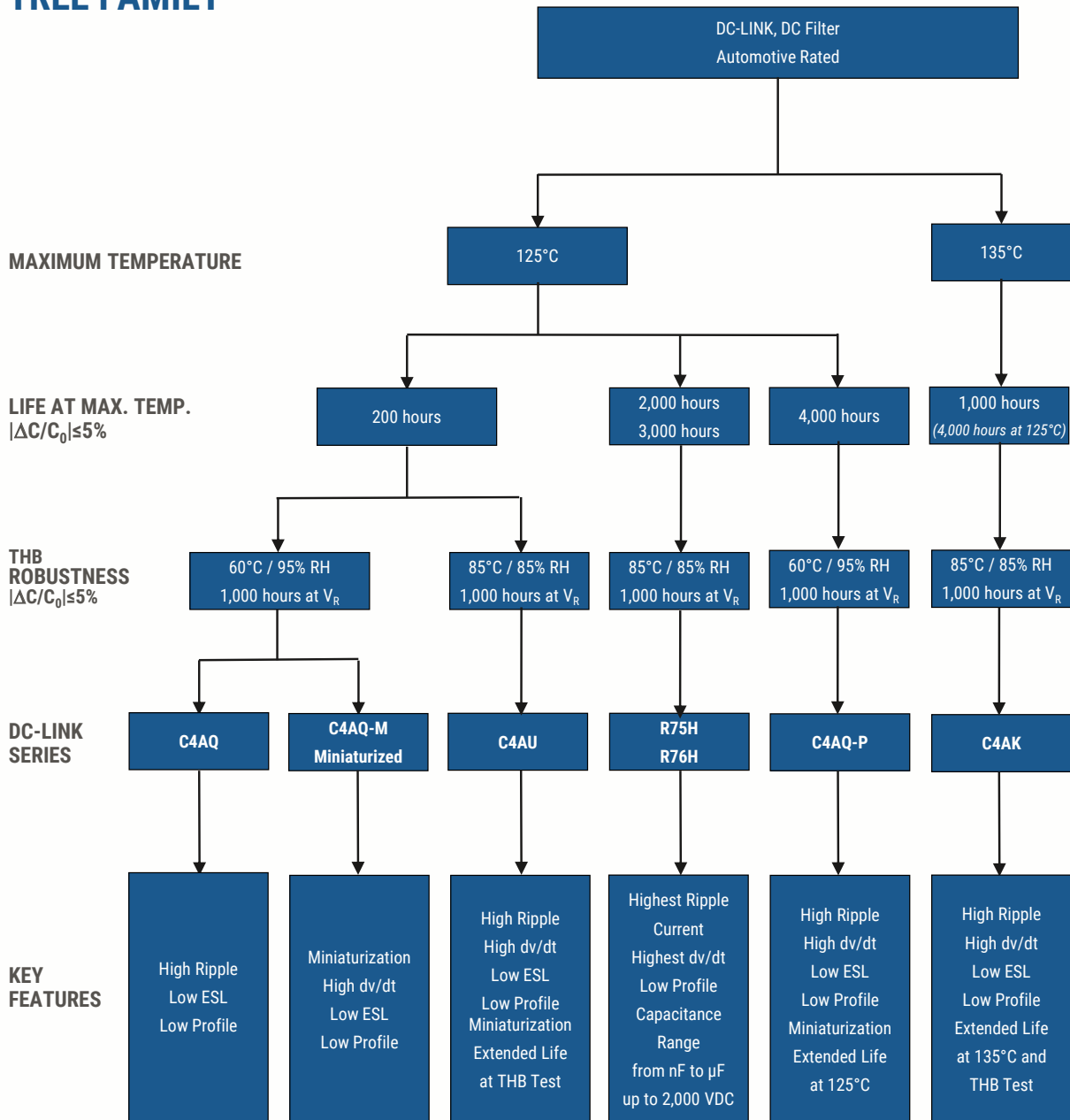

©KEMET Corporation. All Rights Reserved.

Dimensions – Millimeters

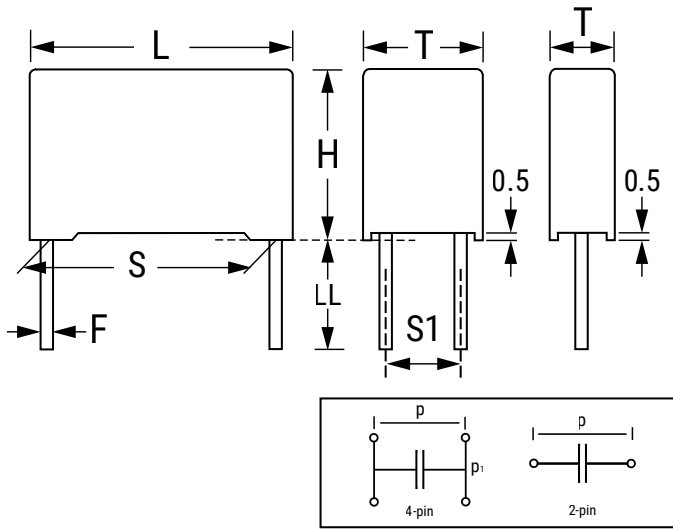

| Size Code | | S | | S1 | | T | | H | | L | | LL | | F | |
|-----------|----------|---------|-----------|---------|-----------|---------|-----------|---------|-----------|---------|-----------|---------|-----------|---------|-----------|
| Digit 6 | Digit 14 | Nominal | Tolerance | Nominal | Tolerance | Nominal | Tolerance | Nominal | Tolerance | Nominal | Tolerance | Nominal | Tolerance | Nominal | Tolerance |
| B | W | 27.5 | ±0.4 | - | - | 11.0 | +0.3/-0.7 | 20.0 | +0.2/-0.7 | 31.5 | +0.5/-0.7 | 6 | +0/-2 | 0.8 | ±0.05 |
| B | X | 27.5 | ±0.4 | - | - | 13.0 | +0.3/-0.7 | 25.0 | +0.2/-0.7 | 31.5 | +0.5/-0.7 | 6 | +0/-2 | 0.8 | ±0.05 |
| B | Y | 27.5 | ±0.4 | - | - | 14.0 | +0.3/-0.7 | 28.0 | +0.2/-0.7 | 31.5 | +0.5/-0.7 | 6 | +0/-2 | 0.8 | ±0.05 |
| B | 1 | 27.5 | ±0.4 | - | - | 19.0 | +0.3/-0.7 | 29.0 | +0.2/-0.7 | 31.5 | +0.5/-0.7 | 6 | +0/-2 | 0.8 | ±0.05 |
| B | 2 | 27.5 | ±0.4 | - | - | 22.0 | +0.3/-0.7 | 37.0 | +0.2/-0.7 | 31.5 | +0.5/-0.7 | 6 | +0/-2 | 0.8 | ±0.05 |
| B | F | 37.5 | ±0.4 | 10.2 | ±0.4 | 20.0 | +0.4/-0.7 | 40.0 | +0.2/-0.7 | 42.0 | +0.6/-0.7 | 6 | +0/-2 | 1.2 | ±0.05 |
| B | J | 37.5 | ±0.4 | 10.2 | ±0.4 | 28.0 | +0.4/-0.7 | 37.0 | +0.2/-0.7 | 42.0 | +0.6/-0.7 | 6 | +0/-2 | 1.2 | ±0.05 |
| B | L | 37.5 | ±0.4 | 20.3 | ±0.4 | 30.0 | +0.4/-0.7 | 45.0 | +0.2/-0.7 | 42.0 | +0.6/-0.7 | 6 | +0/-2 | 1.2 | ±0.05 |
| B | O | 37.5 | ±0.4 | 20.3 | ±0.4 | 35.0 | +0.4/-0.7 | 50.0 | +0.2/-0.7 | 42.0 | +0.6/-0.7 | 6 | +0/-2 | 1.2 | ±0.05 |
| B | M | 52.5 | ±0.4 | 20.3 | ±0.4 | 30.0 | +0.5/-0.7 | 45.0 | +0.3/-0.7 | 57.5 | +0.8/-0.7 | 6 | +0/-2 | 1.2 | ±0.05 |
| B | N | 52.5 | ±0.4 | 20.3 | ±0.4 | 35.0 | +0.5/-0.7 | 50.0 | +0.3/-0.7 | 57.5 | +0.8/-0.7 | 6 | +0/-2 | 1.2 | ±0.05 |
| E | A | 52.5 | ±0.4 | 20.3 | ±0.4 | 45.0 | +0.5/-0.7 | 56.0 | +0.3/-0.7 | 57.5 | +0.8/-0.7 | 6 | +0/-2 | 1.2 | ±0.05 |
| E | B | 52.5 | ±0.4 | 20.3 | ±0.4 | 45.0 | +0.5/-0.7 | 65.0 | +0.3/-0.7 | 57.5 | +0.8/-0.7 | 6 | +0/-2 | 1.2 | ±0.05 |
| L | 1 | 27.5 | ±0.4 | - | - | 21.0 | +0.3/-0.7 | 12.5 | +0.2/-0.7 | 32.0 | +0.5/-0.7 | 6 | +0/-2 | 0.8 | ±0.05 |
| L | 2 | 27.5 | ±0.4 | - | - | 24.0 | +0.3/-0.7 | 15.0 | +0.2/-0.7 | 32.0 | +0.5/-0.7 | 6 | +0/-2 | 0.8 | ±0.05 |
| L | 3 | 37.5 | ±0.4 | 10.2 | ±0.4 | 24.0 | +0.4/-0.7 | 19.0 | +0.2/-0.7 | 41.5 | +0.6/-0.7 | 6 | +0/-2 | 1.2 | ±0.05 |
| L | 4 | 37.5 | ±0.4 | 10.2 | ±0.4 | 24.0 | +0.4/-0.7 | 15.0 | +0.2/-0.7 | 41.5 | +0.6/-0.7 | 6 | +0/-2 | 1.2 | ±0.05 |
| L | 6 | 37.5 | ±0.4 | 20.3 | ±0.4 | 35.0 | +0.4/-0.7 | 24.0 | +0.2/-0.7 | 42.0 | +0.6/-0.7 | 6 | +0/-2 | 1.2 | ±0.05 |
| L | 8 | 37.5 | ±0.4 | 20.3 | ±0.4 | 43.0 | +0.4/-0.7 | 25.0 | +0.2/-0.7 | 42.0 | +0.6/-0.7 | 6 | +0/-2 | 1.2 | ±0.05 |
| L | 9 | 27.5 | ±0.4 | - | - | 31.0 | +0.3/-0.7 | 19.0 | +0.2/-0.7 | 32.0 | +0.5/-0.7 | 6 | +0/-2 | 0.8 | ±0.05 |

Qualification

| | |
|---------------------|------------------------------------|
| Reference Standards | IEC 61071, EN 61071, VDE0560 |
| Climatic Category | 55/105/56 according to IEC 60068-1 |

Automotive grade products meet or exceed the requirements outlined by the Automotive Electronics Council. Details regarding test methods and conditions are referenced in document AEC-Q200, Stress Test Qualification for Passive Components. For additional information regarding the Automotive Electronics Council and AEC-Q200, visit the AEC website at www.aecouncil.com.

General Technical Data

| | |
|-------------------|---|
| Dielectric | Polypropylene metallized film, non-inductive type, self-healing property |
| Application | DC filtering, DC link |
| Special Features | AEC-Q200 qualified |
| Climatic Category | 55/105/56 IEC 60068-1 |
| Temperature Range | -55°C to +125°C |
| Endurance Test | 500 hours at $1.3 \times V_{OP} + C/D$ + 500 hours at $1.3 \times V_{OP}$ at 70°C, 85°C, 105°C, 125°C |
| Standard | IEC 61071, EN 61071, VDE0560, AEC-Q200 |
| Protection | Solvent resistant plastic case UL 94 V-0 compliant Thermosetting resin sealing UL 94 V-0 compliant |
| Installation | Any position |
| Leads | Tinned wires, standard lead wire length 6 (+0/-2) mm |
| Packaging | Packed in cardboard trays with protection for the terminals |
| RoHS Compliance | Compliant with Directive 2002/95/EC and Directive 2011/65/EU of the European Parliament and the Council of the EU on 8 June 2011, including the Commission Delegated Directive (EU) 2015/863 that amended Annex II to Directive 2011/65/EU. |

Electrical Characteristics

| | |
|---|---|
| Rated Capacitance Range | 1 – 210 μ F |
| Rated Voltage (V_{NDC}) Range | 450 – 1,100 VDC |
| Capacitance Tolerance | $\pm 5\%$ (J) or $\pm 10\%$ (K) measured at $T = +25^{\circ}\text{C} \pm 5^{\circ}\text{C}$ |
| Dissipation Factor PP Typical ($\text{tg}\delta_0$) | ≤ 0.0002 at 10 kHz with $T = 25^{\circ}\text{C} \pm 5^{\circ}\text{C}$ |
| Surge Voltage | $1.5 * V_{NDC}$ for maximum 10 times in a lifetime at $25^{\circ}\text{C} \pm 5^{\circ}\text{C}$ |
| Overvoltage (IEC 61071) | $1.15 * V_{NDC}$ for maximum 30 minutes, once per day |
| | $1.3 * V_{NDC}$ for maximum 1 minute, once per day |
| Peak Non-Repetitive Current | $1.5 * I_{PKR}$ for maximum 1,000 times in a lifetime |
| Insulation Resistance | $IR \times C \geq 30.000$ seconds at 100 VDC 1 minute at $T = +25^{\circ}\text{C} \pm 5^{\circ}\text{C}$ |
| Capacitance Deviation in Operation | $\pm 2.0\%$ maximum on capacitance value measured at $T = +25^{\circ}\text{C} \pm 5^{\circ}\text{C}$ |
| Temperature Storage | -40 to $+80^{\circ}\text{C}$ |
| Storage time | ≤ 36 months from the date marked on the label glued to the package |
| Permissible Relative Humidity - Storage | Annual average $\leq 70\%$, 85% on 30 days/year randomly distributed throughout year. Dewing not admissible. |

Life Expectancy

| | |
|---------------------------------|---|
| Life Expectancy | 100,000 hours at V_{NDC} at hot spot temperature $T_{HS} = +85^{\circ}\text{C}$ |
| | 19,000 hours at V_{OP105} at hot spot temperature $T_{HS} = +105^{\circ}\text{C}$ |
| | 4,000 hours at V_{OP85} at hot spot temperature $T_{HS} = +125^{\circ}\text{C}$ |
| Capacitance Drop at End of Life | -5% (typical) |
| Failure Rate IEC 61709 | ≤ 140 FIT at V_{NDC} at hot spot temperature $T_{HS} = +85^{\circ}\text{C}$ |

Test Method

| | |
|--|--|
| Test Voltage Between Terminals | $1.5 * V_{NDC}$ for 10 seconds or $1.65 * V_{NDC}$ for 2 seconds, at $T = +25^{\circ}\text{C} \pm 5^{\circ}\text{C}$ |
| Test Voltage Between Terminals and Case | 3.2 k VAC 50 Hz for 2 seconds |
| Damp Heat | IEC 60068-2-78 |
| Change of Temperature | IEC 60068-2-14 |
| Biased Humidity Test 40°C/93% R.H. at V_{NDC} - 1,000 hours | $ \Delta C/C_0 \leq 5\%$ $ \Delta DF/DF_0 \leq 200\%$ (at 10 kHz) $IR \geq 50\%$ of initial limit |
| Biased Humidity Test 60°C/95% R.H. at V_{NDC} - 1,000 hours | $ \Delta C/C_0 \leq 5\%$ $ \Delta DF/DF_0 \leq 200\%$ (at 10 kHz) $IR \geq 100 \text{ M}\Omega$ |
| Biased Humidity Test 85°C/85% R.H. at $0.55 * V_{NDC}$ - 1,000 hours | $ \Delta C/C_0 \leq 5\%$ $ \Delta DF \leq 0.005$ (at 1 kHz) $IR \geq 100 \text{ M}\Omega$ |

Operative Voltage Derating

| | Symbol | Voltage (VDC) | | | | | Life Expectancy (Hours) |
|---|-------------|---------------|-----|-----|------|-------|-------------------------|
| Operating Voltage at 70°C (T_{HS}) | V_{OP70} | 500 | 650 | 800 | 1100 | 1,300 | 100,000 |
| Rated Voltage at 85°C (T_{HS}) | V_{NDC} | 450 | 600 | 700 | 900 | 1,100 | 100,000 |
| Operating Voltage at 105°C (T_{HS}) | V_{OP105} | 350 | 450 | 550 | 700 | 850 | 19,000 |
| Operating Voltage at 115°C (T_{HS}) | V_{OP115} | 315 | 420 | 490 | 630 | 770 | 4,000 |
| Operating Voltage at 125°C (T_{HS}) | V_{OP125} | 270 | 360 | 420 | 540 | 660 | 4,000 |

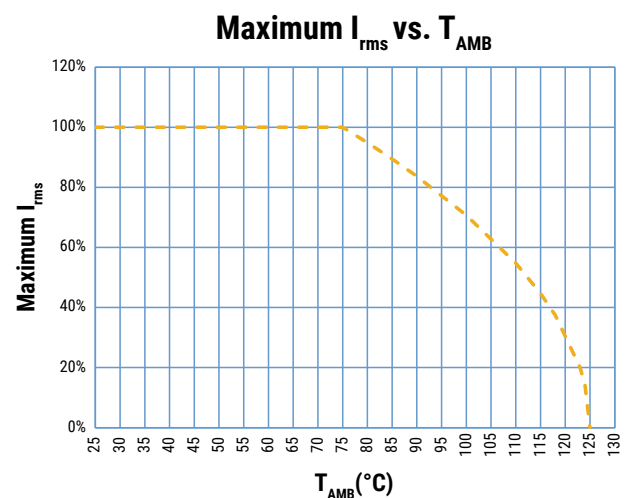
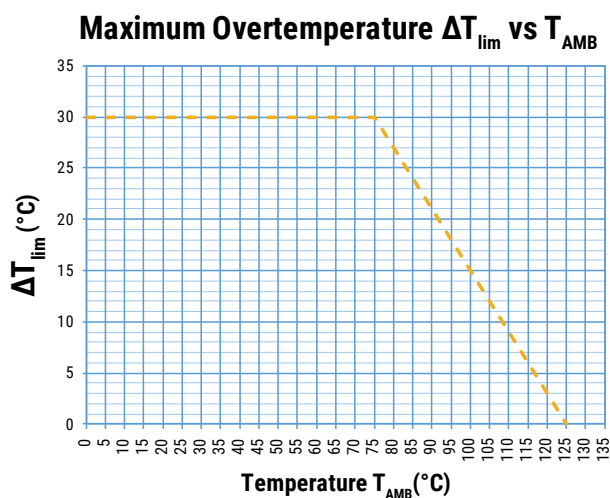

T_{AMB} is the maximum ambient temperature surrounding the capacitor or hottest contact point (e.g. tracks), whichever is higher, in the worst operation conditions in °C.

Typical Waveforms

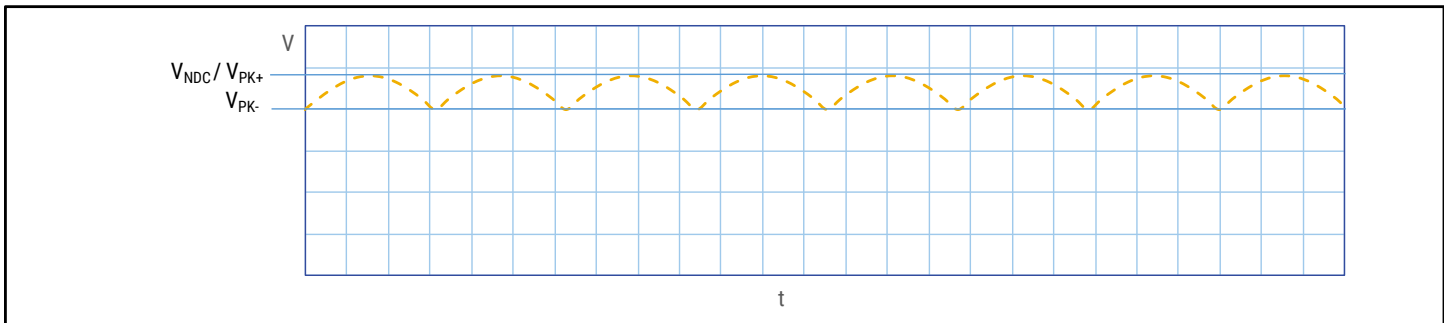
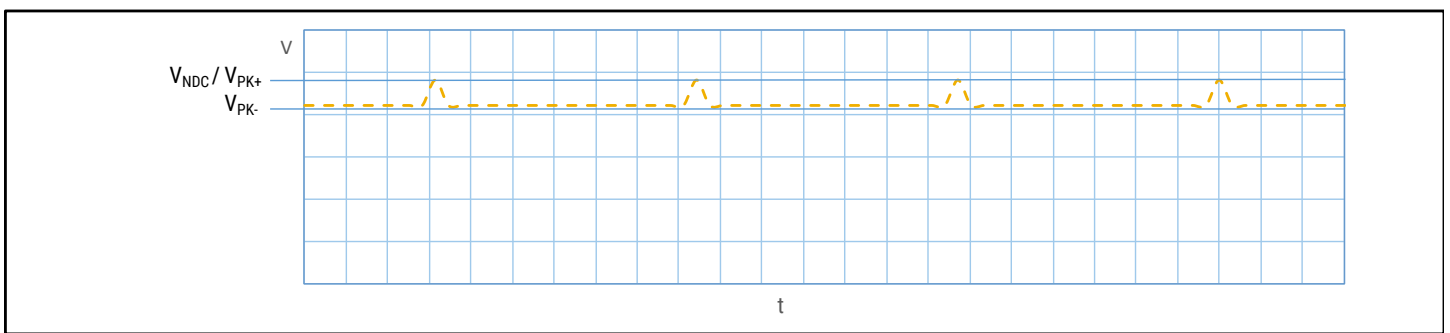
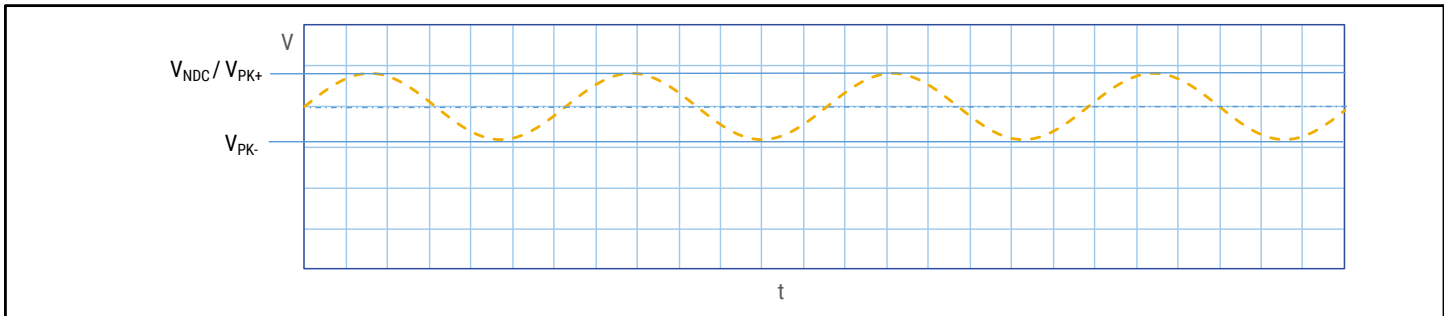

*The applied peak-to-peak ripple voltage shall not exceed $0.2 \times V_{NDC}$.
The peak voltage shall not exceed the rated voltage V_{NDC} .*

Life Expectancy/Failure Quota Graphs

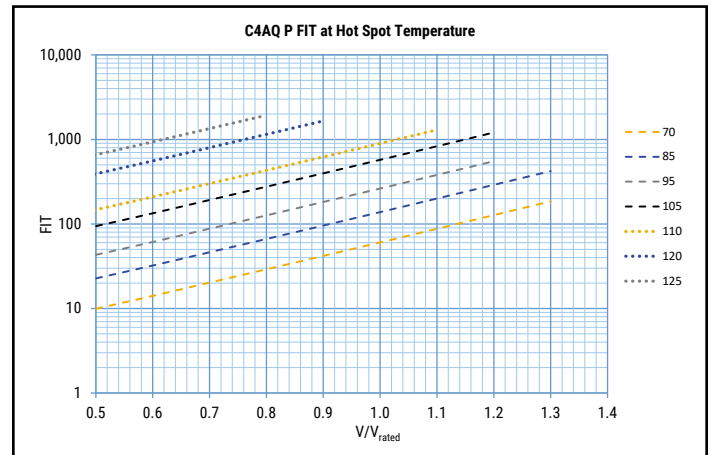
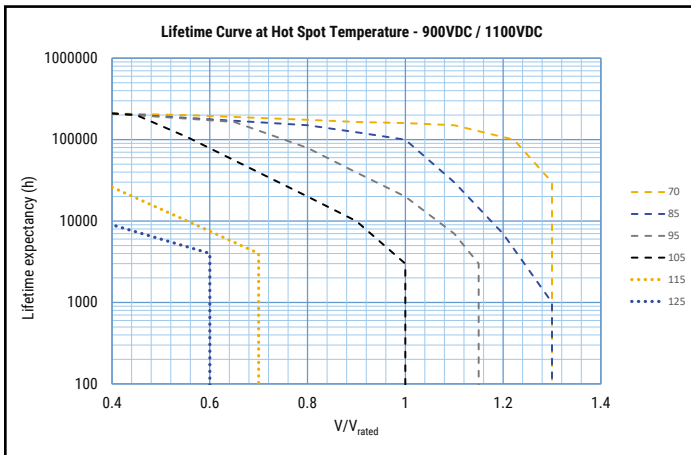
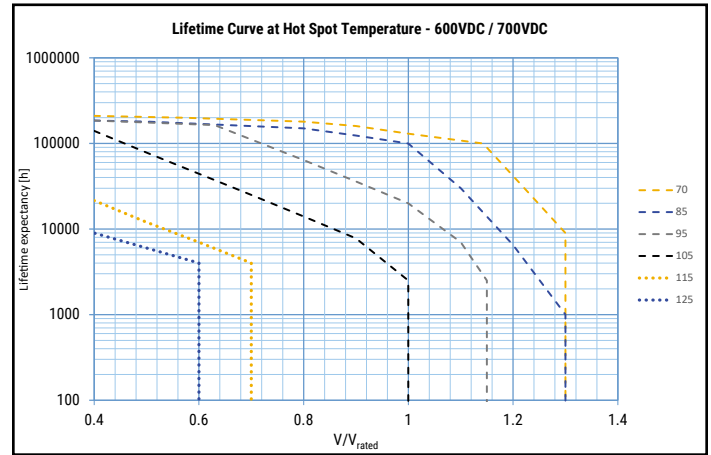
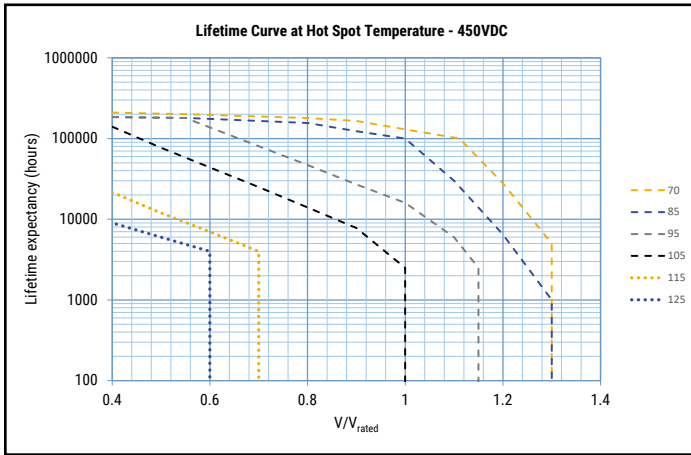

Environmental Compliance

As a leading global supplier of electronic components and an environmentally conscious company, KEMET continually aspires to improve the environmental effects of our manufacturing processes and our finished electronic components.

In Europe (RoHS Directive) and in some other geographical areas such as China (China RoHS), legislation has been enacted to prevent or otherwise limit the use of certain hazardous materials, including lead (Pb), in electronic equipment. KEMET monitors legislation globally to ensure compliance and endeavors to adjust our manufacturing processes and/or electronic components as may be required by applicable law.

For military, medical, automotive, and some commercial applications, the use of lead (Pb) in the termination is necessary and/or required by design. KEMET is committed to communicating RoHS compliance to our customers. Information related to RoHS compliance will be provided in data sheets and using specific identifiers on the packaging labels.

All KEMET power film capacitors are RoHS compliant.

Materials & Environment

The selection of raw materials that KEMET uses for the production of its electronic components is the result of extensive experience. KEMET directs specific attention toward environmental protection. KEMET selects its suppliers according to ISO 9001 standards and performs statistical analyses on raw materials before acceptance for use in manufacturing our electronic components. All materials are, to the best of KEMET's knowledge, non-toxic and free from cadmium; mercury; chrome and compounds; polychlorine triphenyl (PCB); bromide and chlorinedioxins bromurate clorurate; CFC and HCFC; and asbestos.

Dissipation Factor

Dissipation factor is a complex function involved with capacitor inefficiency. The $\tan\delta$ may vary up and down with increased temperature. For more information, refer to Performance Characteristics.

Sealing

Hermetically Sealed Capacitors

As the temperature increases, the pressure inside the capacitor increases. If the internal pressure is high enough, it can cause a breach in the capacitor. Such a breach can result in leakage, impregnation, filling fluid, or moisture susceptibility.

Barometric Pressure

The altitude at which hermetically sealed capacitors are operated controls the capacitor's voltage rating. As the barometric pressure decreases, the susceptibility to terminal arc-over increases. Non-hermetic capacitors can be affected by internal stresses due to pressure changes. These effects can be in the form of capacitance changes, dielectric arc-over, and/or low insulation resistance. Altitude can also affect heat transfer. Heat that is generated in an operation cannot be dissipated properly, and high RI^2 losses and eventual failure can result.

Table 1 – Ratings & Part Number Reference

| Cap Value (µF) | VDC | Dimensions (mm) | | | | | dV/dt V/µs | lpkr Apk | ESL nH | ESR _{typ} at 10 kHz mΩ | Irms* 75°C at 10 kHz Arms | Rth (HS/Amb) (°C/W) | Packaging Quantity | PART NUMBER |
|--|-----|-----------------|----|------|------|------|---------------|-------------|-----------|---------------------------------------|------------------------------------|---------------------------|-----------------------|-----------------|
| | | T | H | L | S | S1 | | | | | | | | |
| V_{NDC} at 85°C = 450 VDC; V_{OP105} at 105°C = 350 VDC; V_{OP115} at 115°C = 310 VDC; V_{OP125} at 125°C = 270 VDC | | | | | | | | | | | | | | |
| 5.6 | 450 | 11 | 20 | 31.5 | 27.5 | \ | 65 | 364 | 17 | 14.0 | 6.8 | 44 | 256 | C4AQGBU4560P1WK |
| 10 | 450 | 13 | 25 | 31.5 | 27.5 | \ | 65 | 650 | 22 | 8.6 | 9.6 | 36 | 234 | C4AQGBU5100P1XK |
| 12.5 | 450 | 14 | 28 | 31.5 | 27.5 | \ | 65 | 813 | 24 | 7.4 | 11.0 | 33 | 96 | C4AQGBU5125P1YK |
| 15 | 450 | 19 | 29 | 31.5 | 27.5 | \ | 65 | 975 | 25 | 6.4 | 12.6 | 29 | 72 | C4AQGBU5150P11K |
| 25 | 450 | 22 | 37 | 31.5 | 27.5 | \ | 65 | 1625 | 28 | 4.8 | 16.0 | 23 | 64 | C4AQGBU5250P12K |
| 40 | 450 | 20 | 40 | 42 | 37.5 | 10.2 | 30 | 1200 | 12 | 3.7 | 19.6 | 20 | 58 | C4AQGBW5400P3FK |
| 50 | 450 | 28 | 37 | 42 | 37.5 | 10.2 | 30 | 1500 | 10 | 3.1 | 22.8 | 18 | 36 | C4AQGBW5500P3JK |
| 70 | 450 | 30 | 45 | 42 | 37.5 | 20.3 | 30 | 2100 | 13 | 2.3 | 29.1 | 15 | 36 | C4AQGBW5700P3LK |
| 90 | 450 | 35 | 50 | 42 | 37.5 | 20.3 | 30 | 2700 | 14 | 1.9 | 35.1 | 13 | 30 | C4AQGBW5900P3OK |
| 100 | 450 | 30 | 45 | 57.5 | 52.5 | 20.3 | 15 | 1500 | 13 | 3.2 | 27.4 | 12 | 27 | C4AQGBW6100P3MK |
| 130 | 450 | 35 | 50 | 57.5 | 52.5 | 20.3 | 15 | 1950 | 15 | 2.5 | 33.3 | 10 | 23 | C4AQGBW6130P3NK |
| 170 | 450 | 45 | 56 | 57.5 | 52.5 | 20.3 | 15 | 2550 | 17 | 2.0 | 41.6 | 8 | 18 | C4AQGEW6170P3AK |
| 210 | 450 | 45 | 65 | 57.5 | 52.5 | 20.3 | 15 | 3150 | 19 | 1.8 | 47.7 | 7 | 18 | C4AQGEW6210P3BK |
| V_{NDC} at 85°C = 600 VDC; V_{OP105} at 105°C = 450 VDC; V_{OP115} at 115°C = 400 VDC; V_{OP125} at 125°C = 350 VDC | | | | | | | | | | | | | | |
| 3.3 | 600 | 11 | 20 | 31.5 | 27.5 | \ | 65 | 215 | 17 | 18.7 | 5.9 | 44 | 256 | C4AQHBU4330P1WJ |
| 5.6 | 600 | 13 | 25 | 31.5 | 27.5 | \ | 65 | 364 | 22 | 11.8 | 8.2 | 36 | 234 | C4AQHBU4560P1XJ |
| 7 | 600 | 14 | 28 | 31.5 | 27.5 | \ | 65 | 455 | 24 | 9.9 | 9.5 | 33 | 96 | C4AQHBU4700P1YJ |
| 10 | 600 | 19 | 29 | 31.5 | 27.5 | \ | 65 | 650 | 25 | 7.5 | 11.7 | 29 | 72 | C4AQHBU5100P11J |
| 15 | 600 | 22 | 37 | 31.5 | 27.5 | \ | 65 | 975 | 28 | 5.8 | 14.6 | 23 | 64 | C4AQHBU5150P12J |
| 20 | 600 | 20 | 40 | 42 | 37.5 | 10.2 | 30 | 600 | 12 | 5.8 | 15.6 | 20 | 58 | C4AQHBW5200P3FJ |
| 30 | 600 | 28 | 37 | 42 | 37.5 | 10.2 | 30 | 900 | 10 | 4.0 | 19.9 | 18 | 36 | C4AQHBW5300P3JJ |
| 40 | 600 | 30 | 45 | 42 | 37.5 | 20.3 | 30 | 1200 | 13 | 3.1 | 24.9 | 15 | 36 | C4AQHBW5400P3LJ |
| 50 | 600 | 35 | 50 | 42 | 37.5 | 20.3 | 30 | 1500 | 14 | 2.5 | 29.9 | 13 | 30 | C4AQHBW5500P3OJ |
| 55 | 600 | 30 | 45 | 57.5 | 52.5 | 20.3 | 15 | 825 | 13 | 4.5 | 23.0 | 12 | 27 | C4AQHBW5550P3MJ |
| 75 | 600 | 35 | 50 | 57.5 | 52.5 | 20.3 | 15 | 1125 | 15 | 3.4 | 28.7 | 10 | 23 | C4AQHBW5750P3NJ |
| 110 | 600 | 45 | 56 | 57.5 | 52.5 | 20.3 | 15 | 1650 | 17 | 2.4 | 37.9 | 8 | 18 | C4AQHEW6110P3AJ |
| 130 | 600 | 45 | 65 | 57.5 | 52.5 | 20.3 | 15 | 1950 | 19 | 2.1 | 42.9 | 7 | 18 | C4AQHEW6130P3BJ |
| V_{NDC} at 85°C = 700 VDC; V_{OP105} at 105°C = 550 VDC; V_{OP115} at 115°C = 470 VDC; V_{OP125} at 125°C = 400 VDC | | | | | | | | | | | | | | |
| 2.7 | 700 | 11 | 20 | 31.5 | 27.5 | \ | 65 | 176 | 17 | 20.1 | 5.7 | 44 | 256 | C4AQJBU4270P1WJ |
| 4 | 700 | 13 | 25 | 31.5 | 27.5 | \ | 65 | 260 | 22 | 14.2 | 7.5 | 36 | 234 | C4AQJBU4400P1XJ |
| 5 | 700 | 14 | 28 | 31.5 | 27.5 | \ | 65 | 325 | 24 | 11.8 | 8.7 | 33 | 96 | C4AQJBU4500P1YJ |
| 8 | 700 | 19 | 29 | 31.5 | 27.5 | \ | 65 | 520 | 25 | 8.0 | 11.2 | 29 | 72 | C4AQJBU4800P11J |
| 12.5 | 700 | 22 | 37 | 31.5 | 27.5 | \ | 65 | 813 | 28 | 6.1 | 14.1 | 23 | 64 | C4AQJBU5125P12J |
| 15 | 700 | 20 | 40 | 42 | 37.5 | 10.2 | 30 | 450 | 12 | 6.8 | 14.5 | 20 | 58 | C4AQJBW5150P3FJ |
| 20 | 700 | 28 | 37 | 42 | 37.5 | 10.2 | 30 | 600 | 10 | 5.2 | 17.4 | 18 | 36 | C4AQJBW5200P3JJ |
| 30 | 700 | 30 | 45 | 42 | 37.5 | 20.3 | 30 | 900 | 13 | 3.5 | 23.2 | 15 | 36 | C4AQJBW5300P3LJ |
| 40 | 700 | 35 | 50 | 42 | 37.5 | 20.3 | 30 | 1200 | 14 | 2.8 | 28.7 | 13 | 30 | C4AQJBW5400P3OJ |
| 45 | 700 | 30 | 45 | 57.5 | 52.5 | 20.3 | 15 | 675 | 13 | 4.8 | 22.3 | 12 | 27 | C4AQJBW5450P3MJ |
| 55 | 700 | 35 | 50 | 57.5 | 52.5 | 20.3 | 15 | 825 | 15 | 4.0 | 26.4 | 10 | 23 | C4AQJBW5550P3NJ |
| 60 | 700 | 35 | 50 | 57.5 | 52.5 | 20.3 | 15 | 900 | 15 | 3.6 | 27.5 | 10 | 23 | C4AQJBW5600P3NJ |
| 85 | 700 | 45 | 56 | 57.5 | 52.5 | 20.3 | 15 | 1275 | 17 | 2.8 | 35.8 | 8 | 18 | C4AQJEW5850P3AJ |
| 100 | 700 | 45 | 65 | 57.5 | 52.5 | 20.3 | 15 | 1500 | 19 | 2.4 | 40.6 | 7 | 18 | C4AQJEW6100P3BJ |
| Cap Value (µF) | VDC | T | H | L | S | S1 | V/µs | Apk | nH | mΩ | Arms | (°C/W) | Packaging Quantity | PART NUMBER |
| | | Dimensions (mm) | | | | | dV/dt | lpkr | ESL | ESR _{typ} at 10 kHz | Irms* 75°C at 10 kHz | Rth (HS/Amb) | | |

(*) I_{rms} value that leads to a ΔT of ≈ 30°C in the hot spot > T_{HS} = T_{AMB} + ΔT = 75°C + 30°C = 105°C. Attention: Hot spot at 105°C reduced the life time!

Table 1 – Ratings & Part Number Reference cont.

| Cap Value (µF) | VDC | Dimensions (mm) | | | | | dV/dt V/µs | Ipkr Apk | ESL nH | ESR _{typ} at 10 kHz mΩ | Irms* 75°C at 10 kHz Arms | Rth (HS/Amb) (°C/W) | Packaging Quantity | PART NUMBER |
|--|-------|-----------------|----|------|------|-------|---------------|-------------|---------------------------------|---------------------------------------|------------------------------------|---------------------------|-----------------------|-----------------|
| | | T | H | L | S | S1 | | | | | | | | |
| V_{NDC} at 85°C = 900 VDC; V_{OP105} at 105°C = 700 VDC; V_{OP115} at 115°C = 600 VDC; V_{OP125} at 125°C = 500 VDC | | | | | | | | | | | | | | |
| 1.5 | 900 | 11 | 20 | 31.5 | 27.5 | \ | 70 | 105 | 17 | 28.9 | 4.8 | 44 | 256 | C4AQ0BU4150P1WJ |
| 2.7 | 900 | 13 | 25 | 31.5 | 27.5 | \ | 70 | 189 | 22 | 16.8 | 6.9 | 36 | 234 | C4AQ0BU4270P1XJ |
| 3.3 | 900 | 14 | 28 | 31.5 | 27.5 | \ | 70 | 231 | 24 | 14.2 | 7.9 | 33 | 96 | C4AQ0BU4330P1VJ |
| 5 | 900 | 19 | 29 | 31.5 | 27.5 | \ | 70 | 350 | 25 | 10.0 | 10.1 | 29 | 72 | C4AQ0BU4500P11J |
| 8 | 900 | 22 | 37 | 31.5 | 27.5 | \ | 70 | 560 | 28 | 7.3 | 13.2 | 23 | 64 | C4AQ0BU4800P12J |
| 12 | 900 | 20 | 40 | 42 | 37.5 | 10.2 | 35 | 420 | 12 | 6.9 | 14.4 | 20 | 58 | C4AQ0BW5120P3FJ |
| 14 | 900 | 28 | 37 | 42 | 37.5 | 10.2 | 35 | 490 | 10 | 5.9 | 16.3 | 18 | 36 | C4AQ0BW5140P3JJ |
| 20 | 900 | 30 | 45 | 42 | 37.5 | 20.3 | 35 | 700 | 13 | 4.3 | 21.2 | 15 | 36 | C4AQ0BW5200P3LJ |
| 25 | 900 | 35 | 50 | 42 | 37.5 | 20.3 | 35 | 875 | 14 | 3.5 | 25.5 | 13 | 30 | C4AQ0BW5250P3OJ |
| 30 | 900 | 30 | 45 | 57.5 | 52.5 | 20.3 | 15 | 450 | 13 | 5.7 | 20.4 | 12 | 27 | C4AQ0BW5300P3MJ |
| 40 | 900 | 35 | 50 | 57.5 | 52.5 | 20.3 | 15 | 600 | 15 | 4.4 | 25.2 | 10 | 23 | C4AQ0BW5400P3NJ |
| 55 | 900 | 45 | 56 | 57.5 | 52.5 | 20.3 | 15 | 825 | 17 | 3.3 | 32.5 | 8 | 18 | C4AQ0EW5550P3AJ |
| 65 | 900 | 45 | 65 | 57.5 | 52.5 | 20.3 | 15 | 975 | 19 | 2.9 | 37.0 | 7 | 18 | C4AQ0EW5650P3BJ |
| V_{NDC} at 85°C = 1,100 VDC; V_{OP105} at 105°C = 850 VDC; V_{OP115} at 115°C = 720 VDC; V_{OP125} at 125°C = 600 VDC | | | | | | | | | | | | | | |
| 1 | 1,100 | 11 | 20 | 31.5 | 27.5 | \ | 80 | 80 | 17 | 36.4 | 4.2 | 44 | 256 | C4AQQBU4100P1WJ |
| 1.8 | 1,100 | 13 | 25 | 31.5 | 27.5 | \ | 80 | 144 | 22 | 21.0 | 6.2 | 36 | 234 | C4AQQBU4180P1XJ |
| 2.2 | 1,100 | 14 | 28 | 31.5 | 27.5 | \ | 80 | 176 | 24 | 17.6 | 7.1 | 33 | 96 | C4AQQBU4220P1VJ |
| 3.3 | 1,100 | 19 | 29 | 31.5 | 27.5 | \ | 80 | 264 | 25 | 12.3 | 9.1 | 29 | 72 | C4AQQBU4330P11J |
| 5 | 1,100 | 22 | 37 | 31.5 | 27.5 | \ | 80 | 400 | 28 | 9.0 | 11.8 | 23 | 64 | C4AQQBU4500P12J |
| 8 | 1,100 | 20 | 40 | 42 | 37.5 | 10.2 | 40 | 320 | 12 | 8.7 | 12.9 | 20 | 58 | C4AQQBW4800P3FJ |
| 10 | 1,100 | 28 | 37 | 42 | 37.5 | 10.2 | 40 | 400 | 10 | 6.9 | 15.0 | 18 | 36 | C4AQQBW5100P3JJ |
| 12 | 1,100 | 30 | 45 | 42 | 37.5 | 20.3 | 40 | 480 | 13 | 5.8 | 18.1 | 15 | 36 | C4AQQBW5120P3LJ |
| 18 | 1,100 | 35 | 50 | 42 | 37.5 | 20.3 | 40 | 720 | 14 | 4.1 | 23.7 | 13 | 30 | C4AQQBW5180P3OJ |
| 20 | 1,100 | 30 | 45 | 57.5 | 52.5 | 20.3 | 20 | 400 | 13 | 7.2 | 18.3 | 12 | 27 | C4AQQBW5200P3MJ |
| 25 | 1,100 | 35 | 50 | 57.5 | 52.5 | 20.3 | 20 | 500 | 15 | 5.7 | 22.0 | 10 | 23 | C4AQQBW5250P3NJ |
| 27 | 1,100 | 35 | 50 | 57.5 | 52.5 | 20.3 | 20 | 540 | 15 | 5.4 | 22.8 | 10 | 23 | C4AQQBW5270P3NJ |
| 38 | 1,100 | 45 | 56 | 57.5 | 52.5 | 20.3 | 20 | 760 | 17 | 4.0 | 29.8 | 8 | 18 | C4AQQEW5380P3AJ |
| 45 | 1,100 | 45 | 65 | 57.5 | 52.5 | 20.3 | 20 | 900 | 19 | 3.4 | 34.0 | 7 | 18 | C4AQQEW5450P3BJ |
| Cap Value (µF) | VDC | T | H | L | S | S1 | V/µs | Apk | nH | mΩ | Arms | (°C/W) | Packaging Quantity | PART NUMBER |
| Dimensions (mm) | | | | | | dV/dt | Ipkr | ESL | ESR _{typ} at 10 kHz | Irms* 75°C at 10 kHz | Rth (HS/Amb) | | | |

(*) I_{rms} value that leads to a ΔT of ≈ 30°C in the hot spot > T_{HS} = T_{AMB} + ΔT = 75°C + 30°C = 105°C. Attention: Hot spot at 105°C reduced the life time!

Table 2 – Ratings & Part Number Reference for Low Profile Design

| Cap Value (µF) | VDC | Dimensions (mm) | | | | | dV/dt V/µs | lpkr Apk | ESL nH | ESR _{typ} at 10 kHz mΩ | Irms* 75°C at 10 kHz Arms | Rth (HS/Amb) (°C/W) | Packaging Quantity | PART NUMBER |
|--|-------|-----------------|------|------|------|------|------------|----------|--------|---------------------------------|---------------------------|---------------------|--------------------|-----------------|
| | | T | H | L | S | S1 | | | | | | | | |
| V_{NDC} at 85°C = 450 VDC; V_{OP105} at 105°C = 350 VDC; V_{OP115} at 115°C = 310 VDC; V_{OP125} at 125°C = 270 VDC | | | | | | | | | | | | | | |
| 5.6 | 450 | 21 | 12.5 | 32 | 27.5 | \ | 65 | 364 | 11 | 13.6 | 6.8 | 46 | 192 | C4AAGLU4560P11K |
| 8 | 450 | 24 | 15 | 32 | 27.5 | \ | 65 | 520 | 13 | 10.0 | 8.6 | 39 | 168 | C4AAGLU4800P12K |
| 15 | 450 | 31 | 19 | 32 | 27.5 | \ | 65 | 975 | 16 | 6.1 | 12.6 | 30 | 80 | C4AAGLU5150P19K |
| 12 | 450 | 24 | 15 | 41.5 | 37.5 | 10.2 | 30 | 360 | 7 | 11.8 | 8.6 | 33 | 132 | C4AAGLU5120P34K |
| 16 | 450 | 24 | 19 | 41.5 | 37.5 | 10.2 | 30 | 480 | 8 | 8.9 | 10.5 | 29 | 88 | C4AAGLU5160P33K |
| 36 | 450 | 35 | 24 | 42 | 37.5 | 20.3 | 30 | 1080 | 9 | 4.1 | 17.8 | 23 | 60 | C4AAGLU5360P36K |
| 45 | 450 | 43 | 25 | 42 | 37.5 | 20.3 | 30 | 1350 | 9 | 3.3 | 21.4 | 19 | 48 | C4AAGLU5450P38K |
| V_{NDC} at 85°C = 600 VDC; V_{OP105} at 105°C = 450 VDC; V_{OP115} at 115°C = 400 VDC; V_{OP125} at 125°C = 350 VDC | | | | | | | | | | | | | | |
| 3.3 | 600 | 21 | 12.5 | 32 | 27.5 | \ | 65 | 215 | 11 | 18.5 | 5.8 | 46 | 192 | C4AAGLU4330P11J |
| 5 | 600 | 24 | 15 | 32 | 27.5 | \ | 65 | 325 | 13 | 12.7 | 7.7 | 39 | 168 | C4AAGLU4500P12J |
| 10 | 600 | 31 | 19 | 32 | 27.5 | \ | 65 | 650 | 16 | 7.0 | 11.7 | 30 | 80 | C4AAGLU5100P19J |
| 7.5 | 600 | 24 | 15 | 41.5 | 37.5 | 10.2 | 30 | 225 | 7 | 15.2 | 7.6 | 33 | 132 | C4AAGLU4750P34J |
| 10 | 600 | 24 | 19 | 41.5 | 37.5 | 10.2 | 30 | 300 | 8 | 11.4 | 9.3 | 29 | 88 | C4AAGLU5100P33J |
| 20 | 600 | 35 | 24 | 42 | 37.5 | 20.3 | 30 | 600 | 10 | 5.8 | 14.8 | 23 | 60 | C4AAGLU5200P36J |
| 30 | 600 | 43 | 25 | 42 | 37.5 | 20.3 | 30 | 900 | 9 | 4.0 | 19.5 | 19 | 48 | C4AAGLU5300P38K |
| V_{NDC} at 85°C = 700 VDC; V_{OP105} at 105°C = 550 VDC; V_{OP115} at 115°C = 470 VDC; V_{OP125} at 125°C = 400 VDC | | | | | | | | | | | | | | |
| 2.7 | 700 | 21 | 12.5 | 32 | 27.5 | \ | 65 | 176 | 11 | 19.8 | 5.6 | 46 | 192 | C4AAGLU4270P11J |
| 3.8 | 700 | 24 | 15 | 32 | 27.5 | \ | 65 | 247 | 13 | 14.5 | 7.1 | 39 | 168 | C4AAGLU4380P12J |
| 7.5 | 700 | 31 | 19 | 32 | 27.5 | \ | 65 | 488 | 16 | 8.0 | 10.9 | 30 | 80 | C4AAGLU4750P19J |
| 5.8 | 700 | 24 | 15 | 41.5 | 37.5 | 10.2 | 30 | 174 | 7 | 17.3 | 7.1 | 33 | 132 | C4AAGLU4580P34J |
| 8 | 700 | 24 | 19 | 41.5 | 37.5 | 10.2 | 30 | 240 | 8 | 12.5 | 8.9 | 29 | 88 | C4AAGLU4800P33J |
| 15 | 700 | 35 | 24 | 42 | 37.5 | 20.3 | 30 | 450 | 9 | 6.8 | 13.7 | 23 | 60 | C4AAGLU5150P36J |
| 22 | 700 | 43 | 25 | 42 | 37.5 | 20.3 | 30 | 660 | 9 | 4.7 | 17.9 | 19 | 48 | C4AAGLU5220P38J |
| V_{NDC} at 85°C = 900 VDC; V_{OP105} at 105°C = 700 VDC; V_{OP115} at 115°C = 600 VDC; V_{OP125} at 125°C = 500 VDC | | | | | | | | | | | | | | |
| 1.5 | 900 | 21 | 12.5 | 32 | 27.5 | \ | 70 | 105 | 11 | 28.6 | 4.7 | 46 | 192 | C4AAGLU4150P11J |
| 2.5 | 900 | 24 | 15 | 32 | 27.5 | \ | 70 | 175 | 13 | 17.7 | 6.5 | 39 | 168 | C4AAGLU4250P12J |
| 4.8 | 900 | 31 | 19 | 32 | 27.5 | \ | 70 | 336 | 16 | 9.9 | 9.8 | 30 | 80 | C4AAGLU4480P19J |
| 3.8 | 900 | 24 | 15 | 41.5 | 37.5 | 10.2 | 35 | 133 | 7 | 21.2 | 6.4 | 33 | 132 | C4AAGLU4380P34J |
| 5 | 900 | 24 | 19 | 41.5 | 37.5 | 10.2 | 35 | 175 | 8 | 16.2 | 7.8 | 29 | 88 | C4AAGLU4500P33J |
| 10 | 900 | 35 | 24 | 42 | 37.5 | 20.3 | 35 | 350 | 9 | 8.1 | 12.5 | 23 | 60 | C4AAGLU5100P36J |
| 14 | 900 | 43 | 25 | 42 | 37.5 | 20.3 | 35 | 490 | 9 | 5.9 | 15.9 | 19 | 48 | C4AAGLU5140P38J |
| V_{NDC} at 85°C = 1,100 VDC; V_{OP105} at 105°C = 850 VDC; V_{OP115} at 115°C = 720 VDC; V_{OP125} at 125°C = 600 VDC | | | | | | | | | | | | | | |
| 1 | 1,100 | 21 | 12.5 | 32 | 27.5 | \ | 80 | 80 | 11 | 36.2 | 4.2 | 46 | 192 | C4AAGLU4100P11J |
| 1.8 | 1,100 | 24 | 15 | 32 | 27.5 | \ | 80 | 144 | 13 | 20.7 | 6.0 | 39 | 168 | C4AAGLU4180P12J |
| 3.3 | 1,100 | 31 | 19 | 32 | 27.5 | \ | 80 | 264 | 16 | 11.9 | 9.0 | 30 | 80 | C4AAGLU4330P19J |
| 2.6 | 1,100 | 24 | 15 | 41.5 | 37.5 | 10.2 | 40 | 104 | 7 | 26.1 | 5.8 | 33 | 132 | C4AAGLU4260P34J |
| 3.5 | 1,100 | 24 | 19 | 41.5 | 37.5 | 10.2 | 40 | 140 | 8 | 19.4 | 7.1 | 29 | 88 | C4AAGLU4350P33J |
| 7.5 | 1,100 | 35 | 24 | 42 | 37.5 | 20.3 | 40 | 300 | 9 | 9.1 | 11.8 | 23 | 60 | C4AAGLU4750P36J |
| 10 | 1,100 | 43 | 25 | 42 | 37.5 | 20.3 | 40 | 400 | 9 | 6.9 | 14.7 | 19 | 48 | C4AAGLU5100P38J |
| Cap Value (µF) | VDC | T | H | L | S | S1 | dV/dt V/µs | lpkr Apk | ESL nH | mΩ | Arms | (°C/W) | Packaging Quantity | PART NUMBER |
| | | Dimensions (mm) | | | | | | | | | | | | |

(*) I_{rms} value that leads to a ΔT of ≈ 30°C in the hot spot > T_{HS} = T_{AMB} + ΔT = 75°C + 30°C = 105°C. Attention: Hot spot at 105°C reduced the life time!

Soldering Process

The implementation of the RoHS directive has resulted in the selection of SnAuCu (SAC) alloys, or SnCu alloys, as the primary solder material. This has increased the liquidus temperature from 183°C for a SnPb eutectic alloy to 217 – 221°C for new alloys. As a result, the heat stress to the components, even in wave soldering, has increased considerably due to higher pre-heat and wave temperatures. Polypropylene capacitors are especially sensitive to heat (the melting point of polypropylene is 160 – 170°C). Wave soldering can be destructive, especially for mechanically small polypropylene capacitors (with lead spacing of 5 – 15 mm), and great care must be taken during soldering. The recommended solder profiles from KEMET should be used. Contact KEMET with any questions. In general, the wave soldering curve from IEC Publication 61760-1 Edition 2 serves as a solid guideline for successful soldering. See Figure 1.

Reflow soldering is not recommended for through-hole film capacitors. Exposing capacitors to a soldering profile in excess of the recommended limits may result in degradation or permanent damage to the capacitors.

Do not place the polypropylene capacitor through an adhesive curing oven to cure resin for surface mount components. Insert through-hole parts after curing the surface mount parts. Contact KEMET to discuss the actual temperature profile in the oven, if through-hole components must pass through the adhesive curing process. A maximum two soldering cycles is recommended. Allow time for the capacitor surface temperature to return to normal before the second soldering cycle.

Manual Soldering Recommendations

Following is the recommendation for manual soldering with a soldering iron.



The soldering iron tip temperature should be set at 350°C (+10°C maximum) with the soldering duration not to exceed more than 3 seconds.

Wave Soldering Recommendations

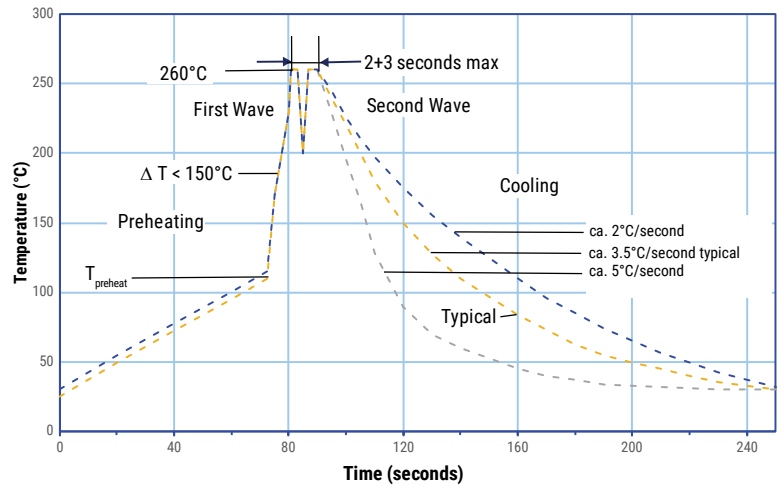

Soldering Process cont.

Wave Soldering Recommendations cont.

1. The tables indicates the maximum set-up temperature of the soldering process

| Dielectric Film Material | Maximum Preheat Temperature | | Maximum Peak Soldering Temperature | |
|--------------------------|------------------------------|---------------------------|------------------------------------|---------------------------|
| | Capacitor Pitch ≤ 15 mm | Capacitor Pitch > 15 mm | Capacitor Pitch ≤ 15 mm | Capacitor Pitch > 15 mm |
| Polyester | 130°C | 130°C | 270°C | 270°C |
| Polypropylene | 110°C | 130°C | 260°C | 270°C |
| Paper | 130°C | 140°C | 270°C | 270°C |
| Polyphenylene Sulphide | 150°C | 160°C | 270°C | 270°C |

2. The maximum temperature measured inside the capacitor: set the temperature so that inside the element the maximum temperature is below the limit.

| Dielectric Film Material | Maximum Temperature Measured Inside the Element |
|--------------------------|---|
| Polyester | 160°C |
| Polypropylene | 110°C |
| Paper | 160°C |
| Polyphenylene Sulphide | 160°C |

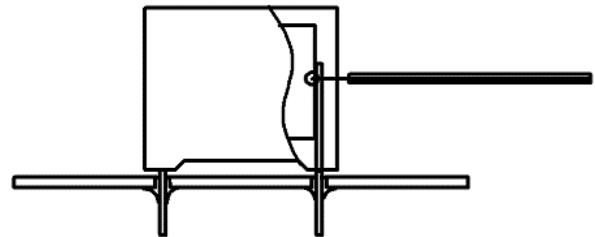

Temperature monitored inside the capacitor.

Selective Soldering Recommendations

Selective dip soldering is a variation of reflow soldering. In this method, the printed circuit board with through-hole components to be soldered is pre-heated and transported over the solder bath, as in normal flow soldering, without touching the solder. When the board is over the bath, it is stopped. Pre-designed solder pots are lifted from the bath with molten solder, only at the places of the selected components, and pressed against the lower surface of the board to solder the components.

The temperature profile for selective soldering is similar to the double wave flow soldering outlined in this document. However, instead of two baths, there is only one with a time from 3 – 10 seconds. In selective soldering, the risk of overheating is greater than in double wave flow soldering, and great care must be taken so that the parts do not overheat.

Mounting

Resistance to Vibration and Mechanical Shock

AEC-Q200 Mechanical Stress Tests:

| | | |
|-------------------------|-------------------------------|---|
| Mechanical Shock | MIL-SDT-202 Method 213 | Test condition C Peak value 100 g, duration 6 ms, half-sine-wave (see MIL-HDBK for details) |
| Vibration | MIL-SDT-202 Method 204 | 5 g for 20 minutes, 12 cycles each of 3 orientations Use 8"X5" PCB, .031" thick. 7 secure points on one 8" side and 2 secure points at corners of opposite sides. Parts mounted within 2" from any secure point. Test from 10 – 2,000 Hz. |

The capacitors are designed for PCB mounting.
 The stand-off pipes must be in good contact with the printed circuit board.
 The capacitor body has to be properly fixed (e.g. clamped or glued).

Construction

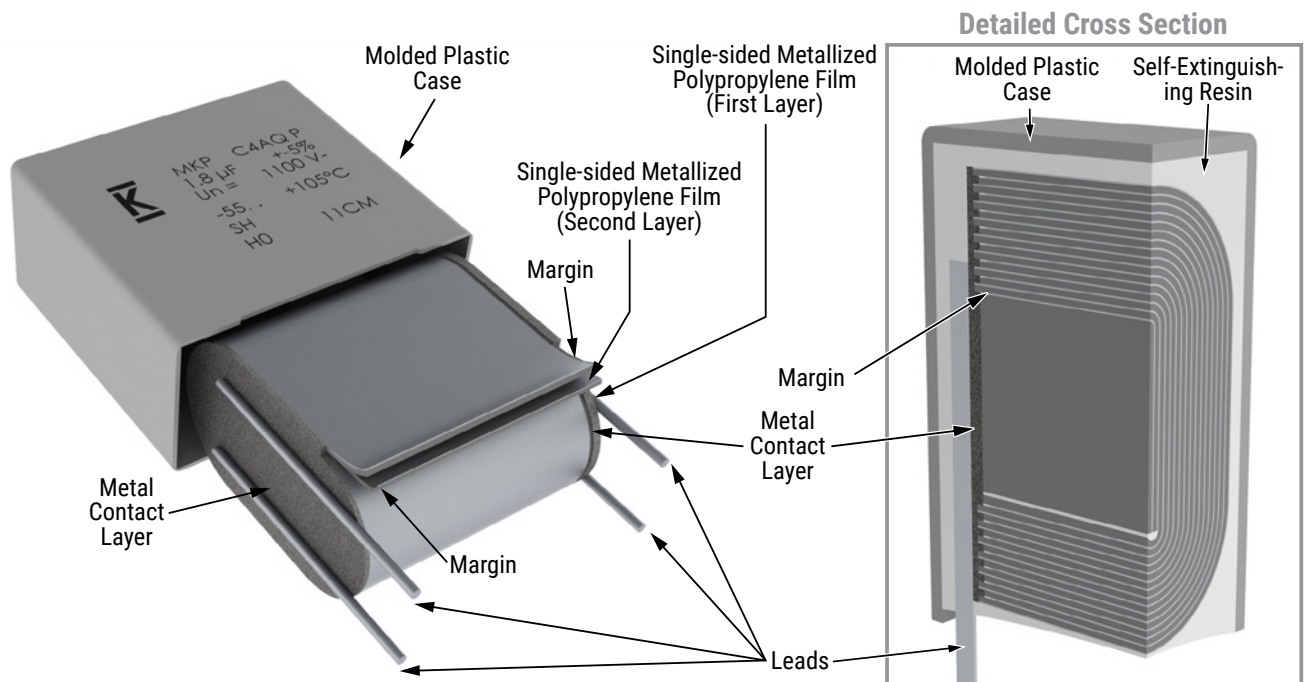

Construction cont.

Low Profile Version:

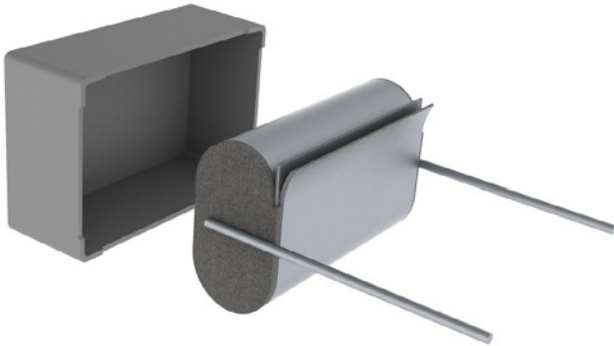

Winding Scheme:

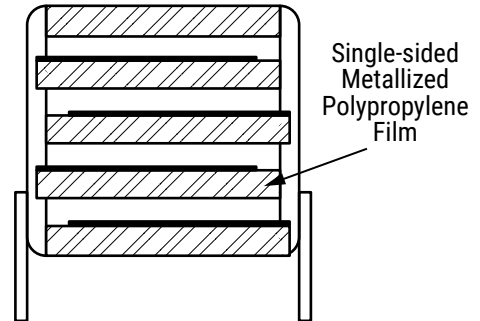

Marking

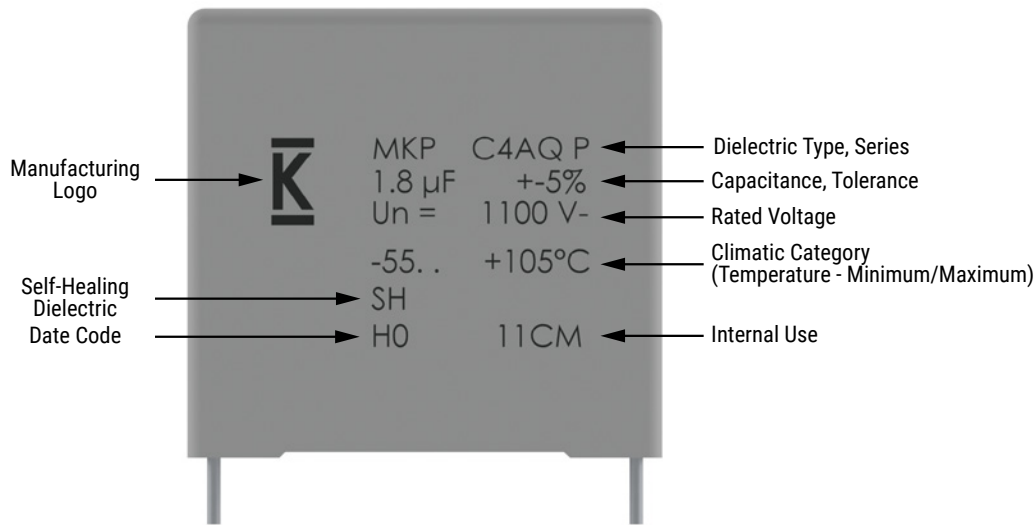

Manufacturing Date Code (IEC-60062)

| Year | Code | Year | Code | Year | Code | Month | Code | Month | Code |
|------|------|------|------|------|------|----------|------|-----------|------|
| 2010 | A | 2017 | J | 2024 | S | January | 1 | July | 7 |
| 2011 | B | 2018 | K | 2025 | T | February | 2 | August | 8 |
| 2012 | C | 2019 | L | 2026 | U | March | 3 | September | 9 |
| 2013 | D | 2020 | M | 2027 | V | April | 4 | October | 0 |
| 2014 | E | 2021 | N | 2028 | W | May | 5 | November | N |
| 2015 | F | 2022 | P | 2029 | X | June | 6 | December | D |
| 2016 | H | 2023 | R | 2030 | A | | | | |

KEMET Electronics Corporation Sales Offices

For a complete list of our global sales offices, please visit www.kemet.com/sales.

Disclaimer

All product specifications, statements, information and data (collectively, the "Information") in this datasheet are subject to change. The customer is responsible for checking and verifying the extent to which the Information contained in this publication is applicable to an order at the time the order is placed. All Information given herein is believed to be accurate and reliable, but it is presented without guarantee, warranty, or responsibility of any kind, expressed or implied.

Statements of suitability for certain applications are based on KEMET Electronics Corporation's ("KEMET") knowledge of typical operating conditions for such applications, but are not intended to constitute – and KEMET specifically disclaims – any warranty concerning suitability for a specific customer application or use. The Information is intended for use only by customers who have the requisite experience and capability to determine the correct products for their application. Any technical advice inferred from this Information or otherwise provided by KEMET with reference to the use of KEMET's products is given gratis, and KEMET assumes no obligation or liability for the advice given or results obtained.

Although KEMET designs and manufactures its products to the most stringent quality and safety standards, given the current state of the art, isolated component failures may still occur. Accordingly, customer applications which require a high degree of reliability or safety should employ suitable designs or other safeguards (such as installation of protective circuitry or redundancies) in order to ensure that the failure of an electrical component does not result in a risk of personal injury or property damage.

Although all product-related warnings, cautions and notes must be observed, the customer should not assume that all safety measures are indicated or that other measures may not be required.

KEMET is a registered trademark of KEMET Electronics Corporation.

X-ON Electronics

Largest Supplier of Electrical and Electronic Components

Click to view similar products for [Film Capacitors](#) category:

Click to view products by [Kemet](#) manufacturer:

Other Similar products are found below :

[M83421/01-3089R](#) [703-6G](#) [F450KG153J250ALH0J](#) [750-1018](#) [FKP1-1000160010P15](#) [FKP1-1500160010P15](#) [FKP1U024707E00KYSD](#)
[82EC1100DQ50K](#) [MMWAF150KME](#) [PCY2130F30153](#) [PFR5101J100J11L16.5TA18](#) [PME261JB5220KR19T0](#) [A521HH333M035C](#)
[QXJ2E474KTPT](#) [QXL2B333KTPT](#) [QXM2G104K](#) [DMT2P22](#) [EEC2G505HQA406](#) [B32234-.033@250V-K](#) [B32520C6332K000](#)
[B32522C6104K000](#) [B32523Q3155J](#) [B32676E6755K](#) [B81133-C1104-M3](#) [MTC355L1](#) [C3B2AD44400B20K](#) [217-0716-001](#) [221A10-120](#)
[KP1830-247/061-G](#) [SCD105K122A3-22](#) [SCD205K122A3-24](#) [F601BL225K063CL60A](#) [FKP1-2202KV5P15](#) [FKS3-680040010P10](#)
[PCX2339F65224](#) [PCX2339F65334](#) [2222 368 55105](#) [2222 370 21683](#) [445450-1](#) [46KI3100JBM1K](#) [4DCNAQ4450ZA0J](#) [MKP 1839-215-633](#)
[MKP 1840-447-165](#) [MKP383510063JKP2T0](#) [MKT182022263473](#) [WMC08P22](#) [WMF1S15](#) [WMF4S68](#) [YE333](#) [ECQ-W4223KZ](#)