

**KEMET Part Number: CKC33C174KDGLCTU**  
(CKC33C174KDGLC7800)

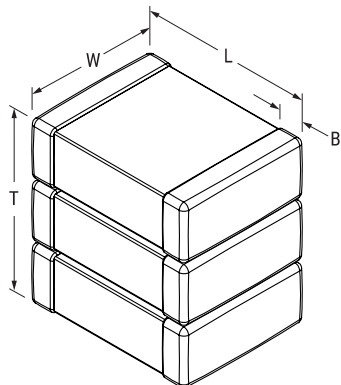

KONNEKT KC-Link, Ceramic, 0.17 uF, 10%, 1000 VDC, C0G, 3-Chip Standard Orientation.



**Dimensions**

<b>L</b>	9.3mm +/-0.6mm
<b>W</b>	10.2mm +/-0.4mm
<b>T</b>	7.7mm +/-0.6mm
<b>B</b>	1.27mm +/-0.4mm

**Packaging Specifications**

<b>Weight:</b>	3.3 g
<b>Packaging:</b>	T&R, 180mm
<b>Packaging Quantity:</b>	75

**General Information**

<b>Series:</b>	KONNEKT KC-Link
<b>Style:</b>	KONNEKT
<b>Description:</b>	KC-LINK with KONNEKT, SMD, MLCC, Ultra-Stable, Class I
<b>Features:</b>	Ultra-Stable
<b>RoHS:</b>	Yes
<b>Termination:</b>	Tin
<b>AEC-Q200:</b>	No
<b>Notes:</b>	3-Chip Standard Orientation.
<b>Chip Size:</b>	3640
<b>MSL:</b>	1

**Specifications**

<b>Capacitance:</b>	0.17 uF
<b>Measurement Condition:</b>	1 kHz 1.0Vrms
<b>Capacitance Tolerance:</b>	10%
<b>Voltage DC:</b>	1000 VDC
<b>Dielectric Withstanding Voltage:</b>	1200 VDC
<b>Temperature Range:</b>	-55/+150°C
<b>Temperature Coefficient:</b>	C0G
<b>Capacitance Change with Reference to +25°C and 0 VDC Applied (TCC):</b>	30 ppm/C, 1kHz 1.0Vrms
<b>Dissipation Factor:</b>	0.1% 1 kHz 1.0Vrms
<b>Aging Rate:</b>	0% Loss/Decade Hour
<b>Insulation Resistance:</b>	5.882 GOhms

Statements of suitability for certain applications are based on our knowledge of typical operating conditions for such applications, but are not intended to constitute - and we specifically disclaim - any warranty concerning suitability for a specific customer application or use. This Information is intended for use only by customers who have the requisite experience and capability to determine the correct products for their application. Any technical advice inferred from this Information or otherwise provided by us with reference to the use of our products is given gratis, and we assume no obligation or liability for the advice given or results obtained.



## X-ON Electronics

Largest Supplier of Electrical and Electronic Components

*Click to view similar products for [Multilayer Ceramic Capacitors MLCC - SMD/SMT category:](#)*

*Click to view products by [Kemet manufacturer:](#)*

Other Similar products are found below :

[D55342E07B523DR-T/R](#) [NCA1206X7R103K50TRPF](#) [NCA1206X7R104K16TRPF](#) [NIN-FB391JTRF](#) [NIN-FC2R7JTRF](#)

[NMC0402NPO220J50TRPF](#) [NMC0402X5R105K6.3TRPF](#) [NMC0402X5R224K6.3TRPF](#) [NMC0402X7R103J25TRPF](#)

[NMC0402X7R153K16TRPF](#) [NMC0603NPO201J50TRPF](#) [NMC0603NPO330G50TRPF](#) [NMC0603NPO331F50TRPF](#)

[NMC0603X5R475M6.3TRPF](#) [NMC0805NPO220J100TRPF](#) [NMC0805NPO270J50TRPF](#) [NMC0805NPO681F50TRPF](#)

[NMC0805NPO820J50TRPF](#) [NMC0805X7R224K25TRPF](#) [NMC1206NPO150J50TRPF](#) [NMC1206X7R106K10TRPLPF](#)

[NMC1210Y5V105Z50TRPLPF](#) [NMC-L0402NPO7R0C50TRPF](#) [NMC-L0603NPO2R2B50TRPF](#) [NMC-Q0402NPO8R2D200TRPF](#)

[C1206C101J1GAC](#) [C1608C0G2A221J](#) [C1608X7R1E334K](#) [C2012C0G2A472J](#) [2220J2K00562KXT](#) [KHC201E225M76N0T00](#)

[1812J2K00332KXT](#) [CDR14BP471CJUR](#) [CDR31BX103AKWR](#) [CDR33BX683AKUS](#) [CGA2B2C0G1H010C](#) [CGA2B2C0G1H040C](#)

[CGA2B2C0G1H050C](#) [CGA2B2C0G1H060D](#) [CGA2B2C0G1H070D](#) [CGA2B2C0G1H120J](#) [CGA2B2C0G1H151J](#) [CGA2B2C0G1H1R5C](#)

[CGA2B2C0G1H2R2C](#) [CGA2B2C0G1H390J](#) [CGA2B2C0G1H391J](#) [CGA2B2C0G1H3R3C](#) [CGA2B2C0G1H680J](#) [CGA2B2C0G1H6R8D](#)

[CGA2B2C0G1H820J](#)