



Overview

KEMET's KC-LINK™ with KONNEKT™ technology surface mount capacitors are designed for high-efficiency and high-density power applications. KONNEKT high density packaging technology uses an innovative Transient Liquid Phase Sintering (TLPS) material to create a surface mount multi-chip solution for high density packaging. By utilizing KEMET's robust and proprietary COG base metal electrode (BME) dielectric system, these capacitors are well suited for power converters, inverters, snubbers, and resonators where high efficiency is a primary concern.

KONNEKT technology enables a low-loss, low-inductance package capable of handling extremely high ripple currents with no change in capacitance versus DC voltage

Benefits

- Extremely high-power density and ripple current capability
- Extremely low equivalent series resistance (ESR)
- Extremely low equivalent series inductance (ESL)
- Low-loss orientation option for higher current handling capability
- Capacitance offerings ranging from 30 – 880 nF
- DC voltage ratings from 500 – 2,000 V
- Operating temperature range of -55°C to +150°C
- No capacitance shift with voltage
- No piezoelectric noise
- High thermal stability
- Surface mountable using standard MLCC reflow profiles

Standard



Low Loss



and negligible change in capacitance versus temperature. With an operating temperature range up to 150°C, these capacitors can be mounted close to fast switching semiconductors in high power density applications, which require minimal cooling. KC-LINK with KONNEKT technology also exhibits high mechanical robustness compared to other dielectric technologies, allowing the capacitor to be mounted without the use of metal frames.

These capacitors can also be mounted in a low-loss orientation to further increase power handling capability. The low-loss orientation lowers ESR (Effective Series Resistance) and ESL (Effective Series Inductance) which increases ripple current handling capability.







Applications

- Wide bandgap (WBG), silicon carbide (SiC) and gallium nitride (GaN) systems
- Data centers
- EV/HEV (drive systems, charging)
- LLC resonant converters
- Switched tank converters
- Wireless charging systems
- Photovoltaic systems
- Power converters
- Inverters
- DC link
- Snubber

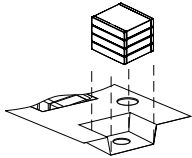
Ordering Information

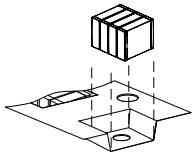
CKC	33	C	884	K	C	G	L	C	XXXX
Series	Case Size (L"x W")	Specification/ Series	Capacitance Code (pF)	Capacitance Tolerance	Rated Voltage (V)	Dielectric	Subclass Designation	Termination Finish	Orientation and Packaging (Suffix/C-Spec)
CKC = KC-LINK	33 = 3640	C = Standard	Two single digits and number of zeros.	K = ±10%	C = 500 V W = 650 V D = 1,000 V E = 1,200 V J = 1,700 V G = 2,000 V	G = COG	L = KONNEKT	C = 100% matte Sn	See "Packaging C-Spec Ordering Options Table"

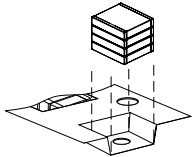
Orientation and Packaging (Suffix/C-Spec) Options Table

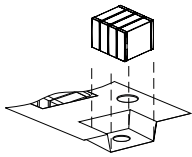
Mounting Orientation ¹	Tape and Reel Illustration	Packaging Type	Packaging/Grade Ordering Code (C-Spec)	
Commercial Grade				
Standard			7" Reel/Unmarked	TU
			13" Reel/Unmarked	7210
Low Loss			7" Reel/Unmarked	7805
			13" Reel/Unmarked	7810
Automotive Grade				
Standard			7" Reel/Unmarked	AUTO
			13" Reel/Unmarked	AUTO7210
Low Loss			7" Reel/Unmarked	AUTO7805
			13" Reel/Unmarked	AUTO7810

¹ Orientation refers to the positioning of the KONNEKT capacitors in the Tape and Reel pockets. This allows pick and place machines to place capacitors on the PCB in the correct orientation.

Automotive C-Spec Information

KEMET automotive grade products meet or exceed the requirements outlined by the Automotive Electronics Council. Details regarding test methods and conditions are referenced in document AEC-Q200, Stress Test Qualification for Passive Components. These products are supported by a Product Change Notification (PCN) and Production Part Approval Process warrant (PPAP).

Automotive products offered through our distribution channel have been assigned an inclusive ordering code C-Spec, "AUTO." This C-Spec was developed in order to better serve small and medium-sized companies that prefer an automotive grade component without the requirement to submit a customer Source Controlled Drawing (SCD) or specification for review by a KEMET engineering specialist. This C-Spec is therefore not intended for use by KEMET OEM automotive customers and are not granted the same "privileges" as other automotive C-Specs. Customer PCN approval and PPAP request levels are limited (see details below.)

Product Change Notification (PCN)

The KEMET product change notification system is used to communicate primarily the following types of changes:

- Product/process changes that affect product form, fit, function, and/or reliability
- Changes in manufacturing site
- Product obsolescence

KEMET Automotive C-Spec	Customer Notification Due To:		Days Prior To Implementation
	Process/Product change	Obsolescence*	
KEMET assigned ¹	Yes (with approval and sign off)	Yes	180 days minimum
AUTO	Yes (without approval)	Yes	90 days minimum

¹ KEMET assigned C-Specs require the submittal of a customer SCD or customer specification for review. For additional information contact KEMET.

Production Part Approval Process (PPAP)

The purpose of the Production Part Approval Process is:

- To ensure that supplier can meet the manufacturability and quality requirements for the purchased parts.
- To provide the evidence that all customer engineering design records and specification requirements are properly understood and fulfilled by the manufacturing organization.
- To demonstrate that the established manufacturing process has the potential to produce the part.

KEMET Automotive C-Spec	PPAP (Product Part Approval Process) Level				
	1	2	3	4	5
KEMET assigned ¹	●	●	●	●	●
AUTO	○		○		

¹ KEMET assigned C-Specs require the submittal of a customer SCD or customer specification for review. For additional information contact KEMET.

- Part number specific PPAP available
- Product family PPAP only

Dimensions – Millimeters (Inches)

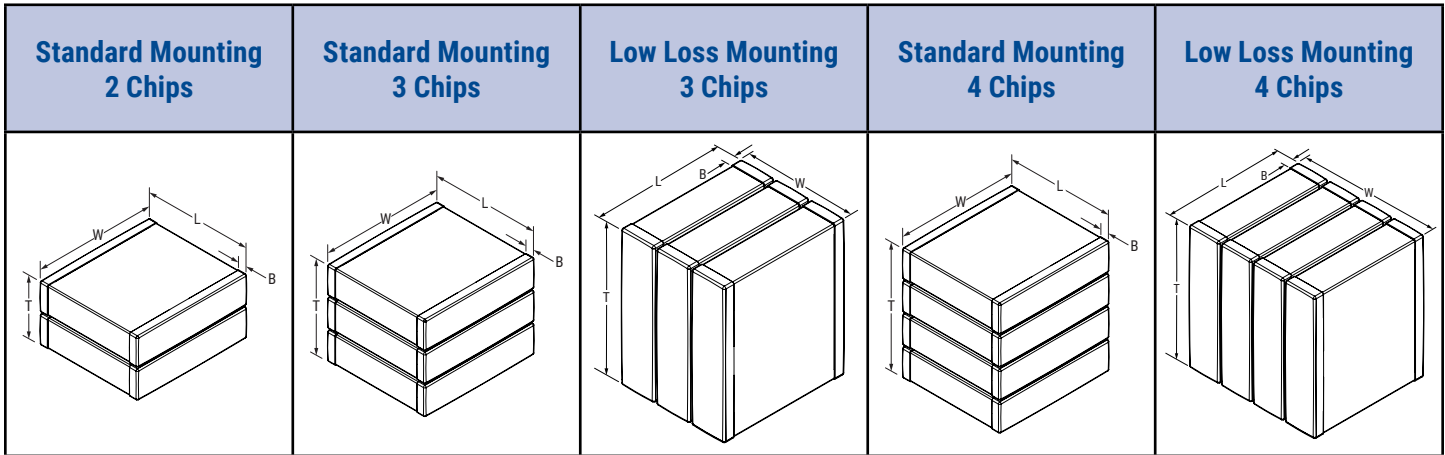

Number of Chips	Mounting	EIA SIZE CODE	METRIC SIZE CODE	L LENGTH	W WIDTH	T THICKNESS	B BANDWIDTH	Mounting Technique	Typical Average Piece Weight (g)
2	Standard	3640	9210	9.30 (0.366) ±0.60 (0.024)	10.20 (0.402) ±0.40 (0.016)	5.10 (0.201) ±0.40 (0.016)	1.27 (0.050) ±0.40 (0.016)	Solder Reflow Only	2.2
3	Standard				10.20 (0.402) ±0.40 (0.016)	7.70 (0.303) ±0.60 (0.24)			3.3
	Low Loss				7.70 (0.303) ±0.60 (0.24)	10.20 (0.402) ±0.40 (0.016)			3.3
4	Standard				10.20 (0.402) ±0.40 (0.016)	10.30 (0.405) ±0.80 (0.031)			4.3
	Low Loss				10.30 (0.405) ±0.80 (0.031)	10.20 (0.402) ±0.40 (0.016)			4.3

Environmental Compliance



Lead (Pb)-free, RoHS, and REACH compliant without exemptions.

Typical Performance

Number of Chips	Mounting Configuration	Typical ESR at 25°C, 100 kHz	Typical ESL at 25°C	Typical Ripple Current
2	Standard	< 2.5 mΩ	< 1.5 nH	See Typical Performance Curves Below
3	Standard	< 2.5 mΩ	< 2.2 nH	
3	Low Loss	< 1.6 mΩ	< 0.75 nH	
4	Standard	< 2.5 mΩ	< 2.7 nH	
4	Low Loss	< 1.1 mΩ	< 0.45 nH	

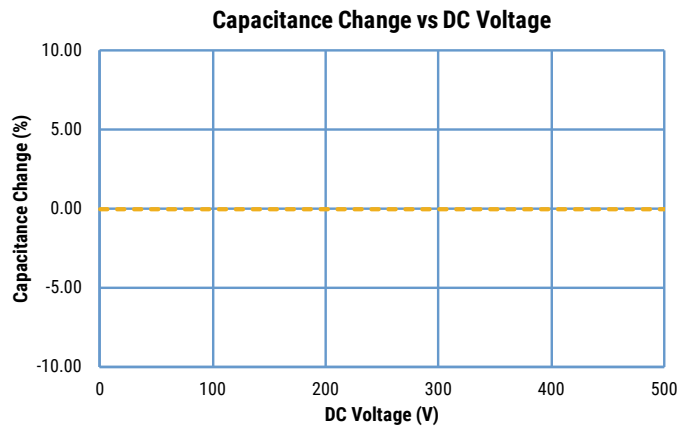
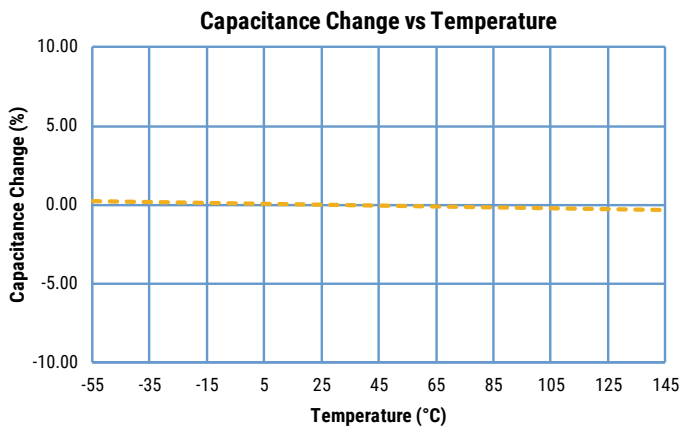

Standard Orientation

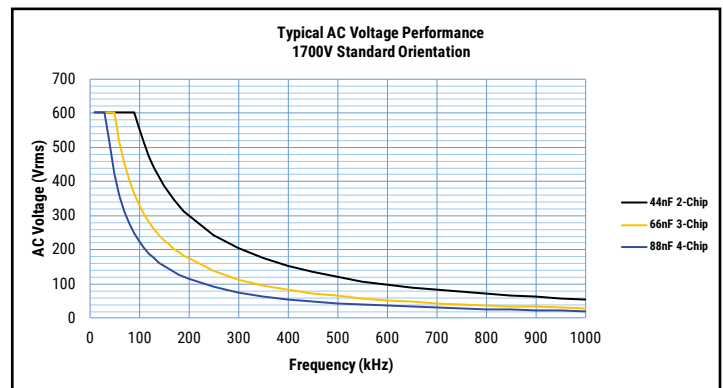
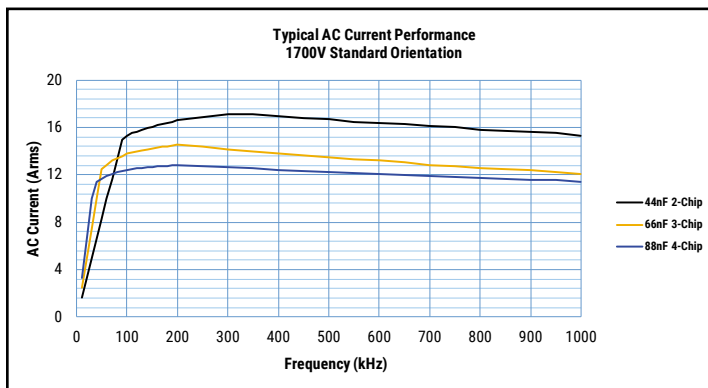

Typical Performance cont.

Standard Orientation

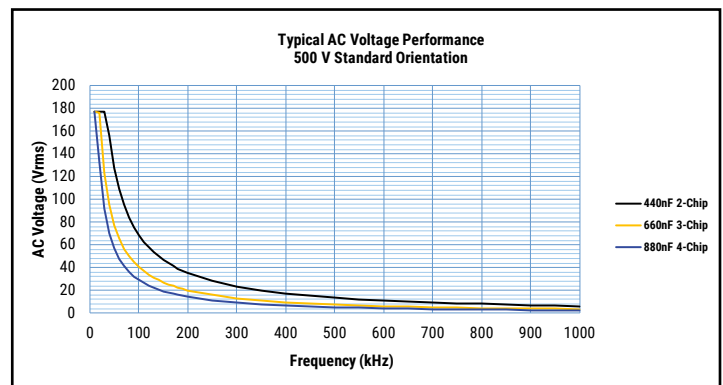
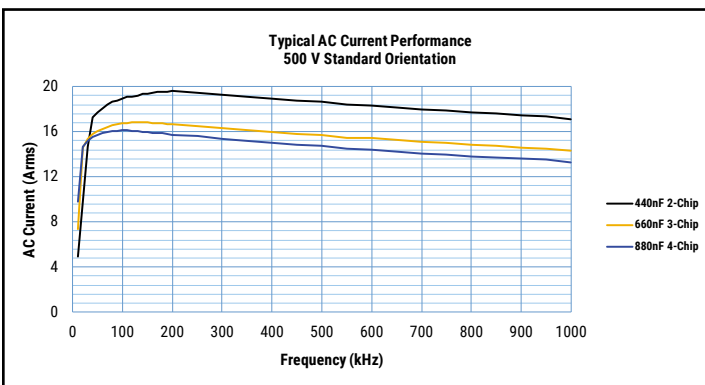
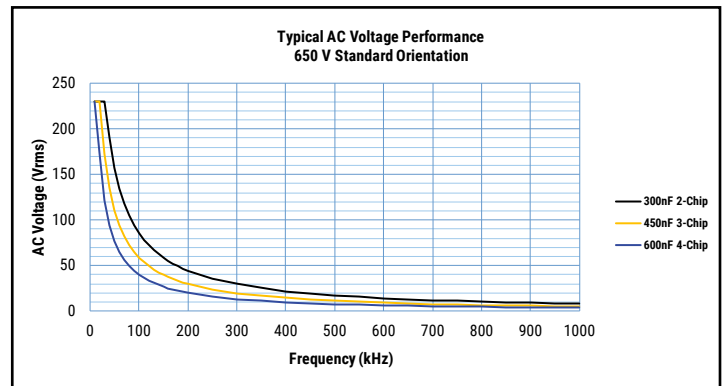
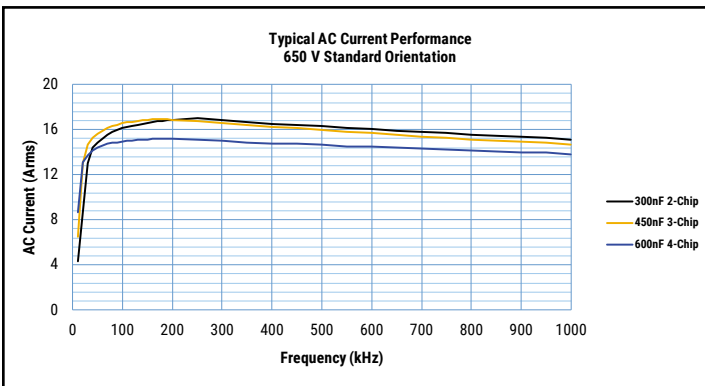
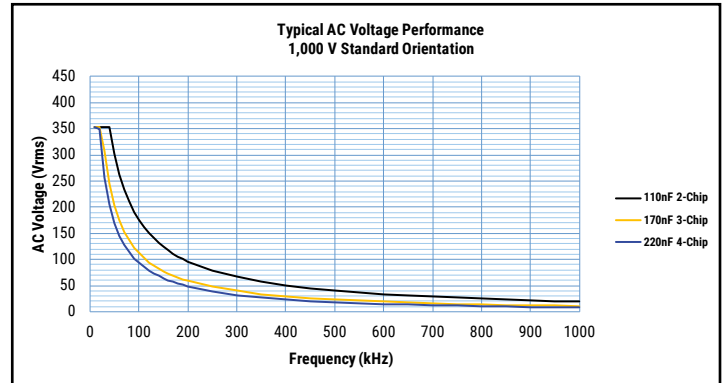
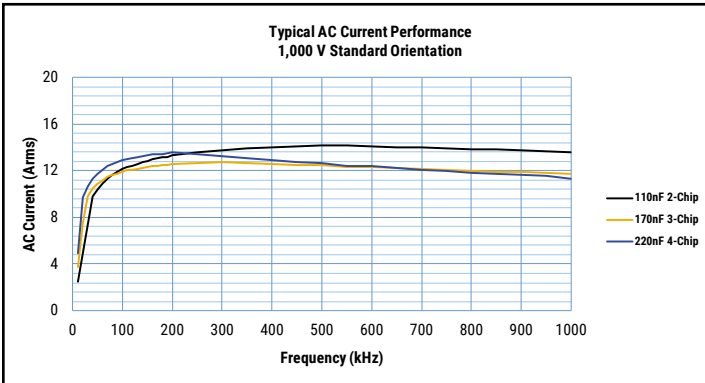
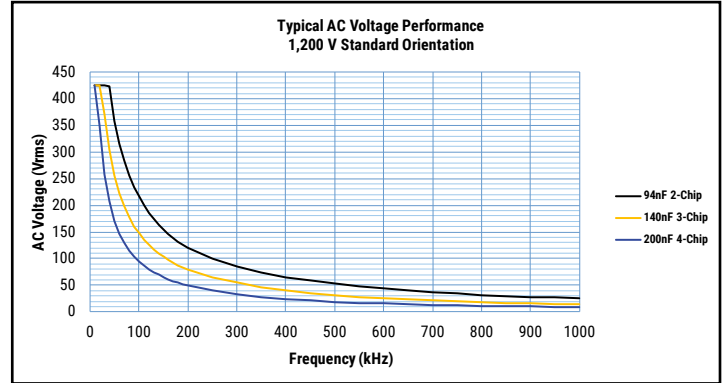
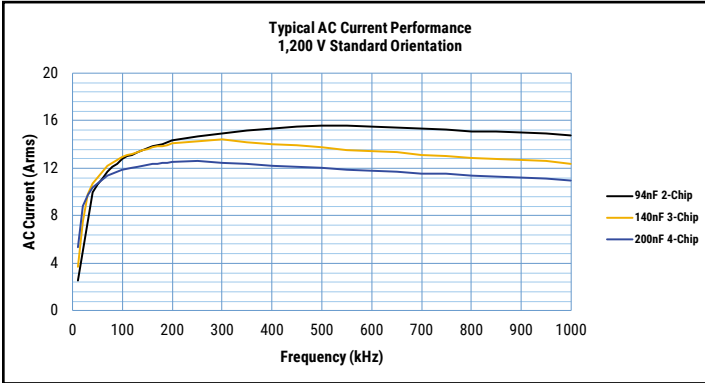

Typical Performance cont.

Low Loss Orientation

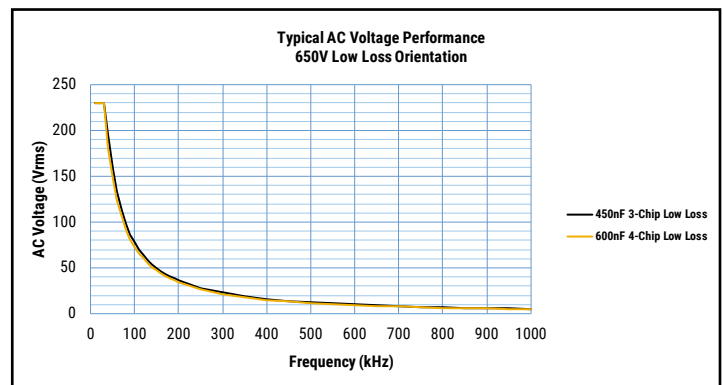
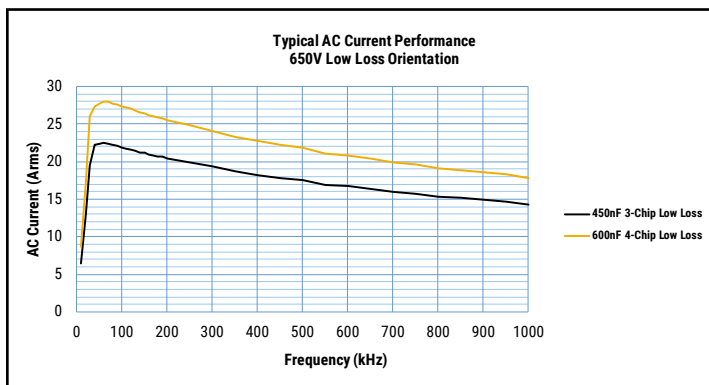
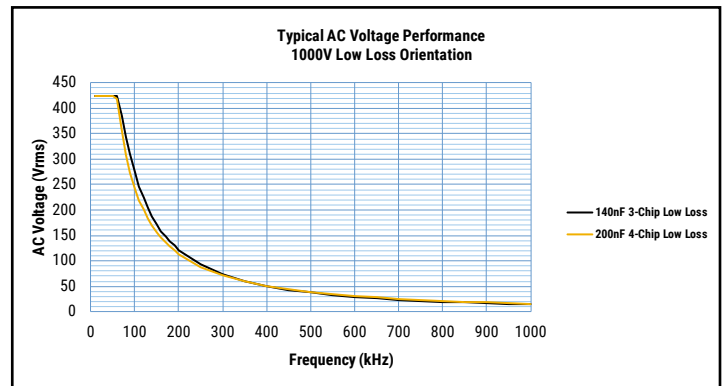
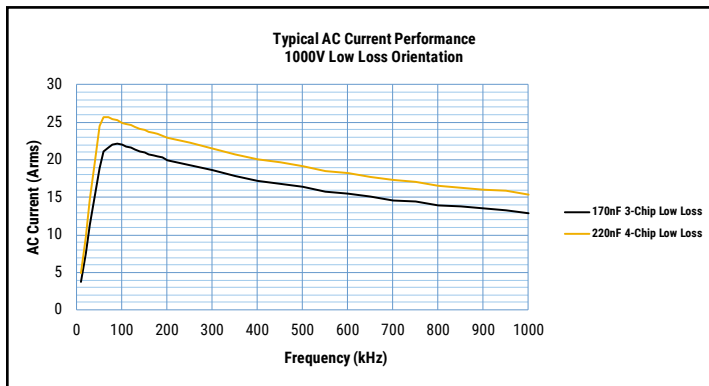
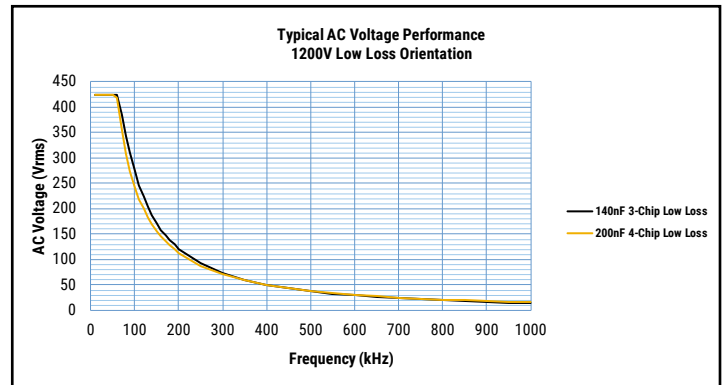
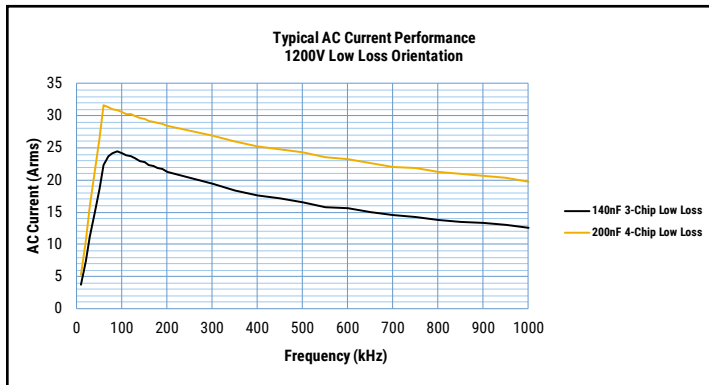
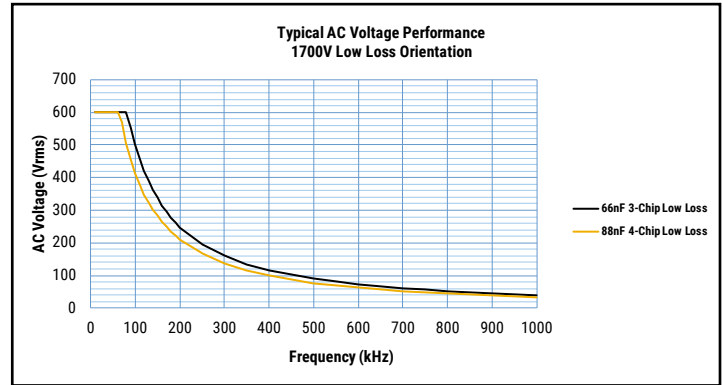
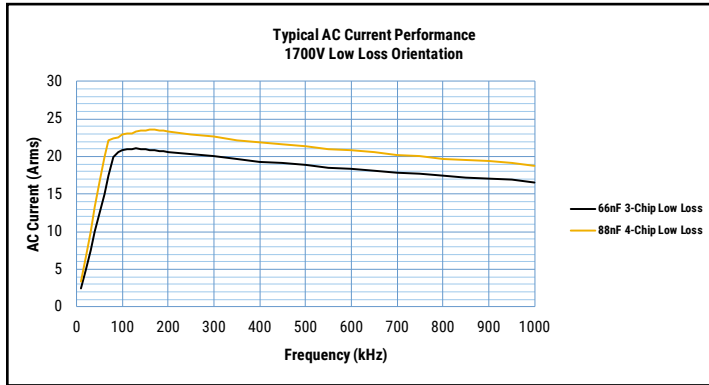

Typical Performance cont.

Low Loss Orientation

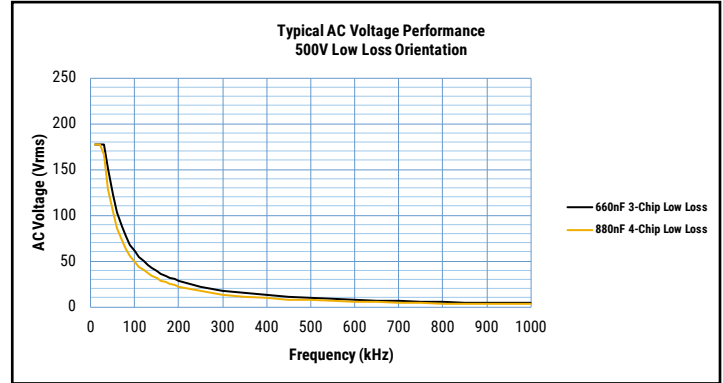
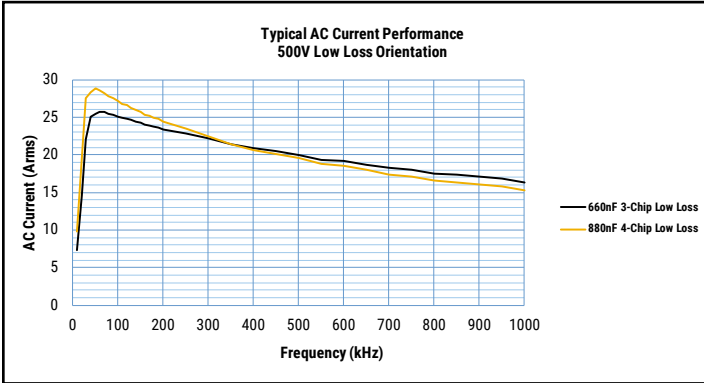

Table 1A - Product Ordering Codes and Ratings

Capacitance	Capacitance Code	Number of Chips	Case Size	3640						
			Voltage Code	C	W	D	E	J	G	
			Rated Voltage (VDC)	500	650	1,000	1,200	1,700	2,000	
			Capacitance Tolerance	Product Availability						
30 nF	303	2	K							•
45 nF	453	3	K							•
60 nF	603	4	K							•
44 nF	443	2	K						•	
66 nF	663	3	K						•	
88 nF	883	4	K						•	
94 nF	943	2	K					•		
140 nF	144	3	K					•		
200 nF	204	4	K					•		
110 nF	114	2	K			•				
170 nF	174	3	K			•				
220 nF	224	4	K			•				
300 nF	304	2	K							
450 nF	454	3	K		•					
600 nF	604	4	K		•					
440 nF	444	2	K	•						
660 nF	664	3	K	•						
880 nF	884	4	K	•						

These products are protected under one or more of the following Patents: US Pat. No. 9,472,342B2, EP Pat. No. 2923366B1, JP Pat. No. 06091639B2, TW Pat. No. 579873B, US Pat. No. 10,068,707B2.

Table 1B – Chip Thickness/Tape & Reel Packaging Quantities

Case Size	Number of Chips	Orientation	Plastic Quantity	
			7" Reel	13" Reel
3640	2	Standard	125	575
	3	Standard	75	375
		Low Loss	50	275
	4	Standard	50	225
		Low Loss	50	225

Table 2 – Performance & Reliability: Test Methods and Conditions

Test	Reference	Test Condition	Limits										
Visual and Mechanical	KEMET Internal	No defects that may affect performance (10X)	Dimensions according KEMET Spec Sheet										
Capacitance (Cap)	KEMET Internal	1 kHz \pm 50 Hz and 1.0 \pm 0.2 V _{rms} if capacitance Capacitance measurements (including tolerance) are indexed to a referee time of 1,000 hours	Within Tolerance										
Dissipation Factor (DF)	KEMET Internal	1 kHz \pm 50 Hz and 1.0 \pm 0.2 V _{rms}	Dissipation factor (DF) maximum limit at 25°C = 0.1%										
Insulation Resistance (IR)	KEMET Internal	500 VDC applied for 120 \pm 5 seconds at 25°C	Within Specification To obtain IR limit, divide M Ω - μ F value by the capacitance and compare to G Ω limit. Select the lower of the two limits. 1,000 M Ω - μ F or 100 G Ω										
Temperature Coefficient of Capacitance (TCC)	KEMET Internal	Frequency: 1 kHz \pm 50 Hz Capacitance change with reference to +25°C and 0 VDC applied. * See part number specification sheet for voltage <table border="1" data-bbox="500 842 870 1045"> <thead> <tr> <th>Step</th> <th>Temperature (°C)</th> </tr> </thead> <tbody> <tr> <td>1</td> <td>+25°C</td> </tr> <tr> <td>2</td> <td>-55°C</td> </tr> <tr> <td>3</td> <td>+25°C (Reference)</td> </tr> <tr> <td>4</td> <td>+150°C</td> </tr> </tbody> </table>	Step	Temperature (°C)	1	+25°C	2	-55°C	3	+25°C (Reference)	4	+150°C	\pm 30 PPM / °C
Step	Temperature (°C)												
1	+25°C												
2	-55°C												
3	+25°C (Reference)												
4	+150°C												
Dielectric Withstanding Voltage (DWV)	KEMET Internal	<table border="1" data-bbox="500 1077 870 1262"> <thead> <tr> <th>Rated DC Voltage</th> <th>DWV Voltage (% of Rated)</th> </tr> </thead> <tbody> <tr> <td>500 V</td> <td>150%</td> </tr> <tr> <td>650 V</td> <td>130%</td> </tr> <tr> <td>\geq 1,000 V</td> <td>120%</td> </tr> </tbody> </table> (5 \pm 1 seconds and charge/discharge not exceeding 50 mA)	Rated DC Voltage	DWV Voltage (% of Rated)	500 V	150%	650 V	130%	\geq 1,000 V	120%	Cap: Initial Limit DF: Initial Limit IR: Initial Limit Withstand test voltage without insulation breakdown or damage.		
Rated DC Voltage	DWV Voltage (% of Rated)												
500 V	150%												
650 V	130%												
\geq 1,000 V	120%												
Aging Rate (Maximum % Capacitance Loss/Decade Hour)	KEMET Internal	Maximum % capacitance loss/decade hour	0% Loss/Decade Hour										
Terminal Strength	Kemet Internal	Shear stress test per specific case size, Time: 60 \pm 1 seconds <table border="1" data-bbox="565 1545 805 1633"> <thead> <tr> <th>Case Size</th> <th>Force</th> </tr> </thead> <tbody> <tr> <td>3640</td> <td>18N</td> </tr> </tbody> </table> 	Case Size	Force	3640	18N	No evidence of mechanical damage						
Case Size	Force												
3640	18N												

Table 2 – Performance & Reliability: Test Methods and Conditions cont.

Test	Reference	Test Condition	Limits
Board Flex	AEC-Q200-005	Standard Termination system 3.0 mm Test time: 60±5 seconds Ramp time: 1 mm/seconds  (Unit : mm)	No evidence of mechanical damage
Solderability	KEMET Custom Test	1. Board shear – SAC305 solder. Shear force of 1.8 kg (minimum) 2. Wetting balance – IEC 60068–2–69	Visual Inspection. 95% coverage on termination. No leaching
Temperature Cycling	JESD22 Method JA-104	1,000 cycles (-55°C to +150°C) 2-3 cycles per hour Soak Time 1 or 5 minutes	Measurement at 24 hours ±4 hours after test conclusion. Cap: Initial Limit DF: Initial Limit IR: Initial Limit
Biased Humidity	MIL-STD-202 Method 103	Load Humidity: 1,000 hours 85°C/85% RH and 200 VDC. Add 100 K Ω resistor. Low Volt Humidity: 1,000 hours 85°C/85% RH and 1.5 V. Add 100 K Ω resistor.	Measurement at 24 hours ±4 hours after test conclusion. Within Post Environmental Limits Cap: ±0.3% or ±0.25 pF shift IR: 10% of Initial Limit DF Limits Maximum: 0.5%
Moisture Resistance	MIL-STD-202 Method 106	Number of cycles required 10, 24 hours per cycle. Steps 7a and 7b not required	Measurement at 24 hours ±4 hours after test conclusion. Within Post Environmental Limits Cap: ±0.3% or ±0.25 pF shift IR: 10% of Initial Limit DF Limits Maximum: 0.5%
Thermal Shock	MIL-STD-202 Method 107	Number of cycles required 5, (-55°C to 125°C) Dwell time 15 minutes.	Cap: Initial Limit DF: Initial Limit IR: Initial Limit
High Temperature Life	MIL-STD-202 Method 108	1,000 hours at 150°C with 1.0 X rated voltage applied.	Within Post Environmental Limits Cap: ±0.3% or ±0.25 pF shift IR: 10% of Initial Limit DF Limits Maximum: 0.5%
Storage Life		1,000 hours at 150°C, Unpowered	
Vibration	MIL-STD-202 Method 204	5 g's for 20 minutes, 12 cycles each of 3 orientations. Test from 10 – 2,000 Hz	Cap: Initial Limit DF: Initial Limit IR: Initial Limit
Mechanical Shock	MIL-STD-202 Method 213	1,500 g's 0.5ms Half-sine, Velocity Change 15.4 ft/second (Condition F)	Cap: Initial Limit DF: Initial Limit IR: Initial Limit
Resistance to Solvents	MIL-STD-202 Method 215	Add Aqueous wash chemical OKEMCLEAN (A 6% concentrated Oakite cleaner) or equivalent. Do not use banned solvents	Visual Inspection 10X Readable marking, no decoloration or stains. No physical damage.

Table 3 – KONNEKT Land Pattern Design Recommendations per IPC-7351 (mm)

Chip Number	Orientation	EIA SIZE CODE	METRIC SIZE CODE	Median (Nominal) Land Protrusion				
				C	Y	X	V1	V2
2	Standard	3640	9210	4.35	1.5	10.6	10.7	11.1
3	Standard			4.35	1.5	10.6	10.7	11.1
	Low Loss			4.35	1.5	8.3	10.7	8.8
4	Standard			4.35	1.5	10.6	10.7	11.1
	Low Loss	4.35	1.5	10.7	10.7	11.2		

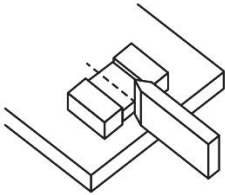
KONNEKT 3640 2-Chip	
Standard	Low Loss
(Land Pattern Design Recommendations per IPC-7351, top view)	
	<p>Not available in Low Loss</p>
KONNEKT 3640 3-Chip	
Standard	Low Loss
(Land Pattern Design Recommendations per IPC-7351, top view)	
KONNEKT 3640 4-Chip	
Standard	Low Loss
(Land Pattern Design Recommendations per IPC-7351, top view)	

Soldering Process

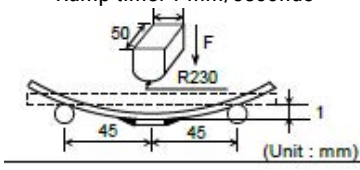
Recommended Reflow Soldering Profile

KEMET's KONNEKT family of high density surface mount multilayer ceramic capacitors (SMD MLCCs) are compatible with convection and IR reflow techniques. Preheating of these components is recommended to avoid extreme thermal stress. KEMET's recommended profile conditions for convection and IR reflow reflect the profile conditions of the IPC/J-STD-020 standard for moisture sensitivity testing. These devices can safely withstand a maximum of three reflow passes at these conditions.

Profile Feature	Termination Finish
	100% matte Sn
Preheat/Soak	
Temperature Minimum (T_{Smin})	150°C
Temperature Maximum (T_{Smax})	200°C
Time (t_s) from T_{Smin} to T_{Smax}	60 – 120 seconds
Ramp-Up Rate (T_L to T_p)	3°C/second maximum
Liquidous Temperature (T_L)	217°C
Time Above Liquidous (t_L)	60 – 150 seconds
Peak Temperature (T_p)	260°C
Time Within 5°C of Maximum Peak Temperature (t_p)	30 seconds maximum
Ramp-Down Rate (T_p to T_L)	6°C/second maximum
Time 25°C to Peak Temperature	8 minutes maximum

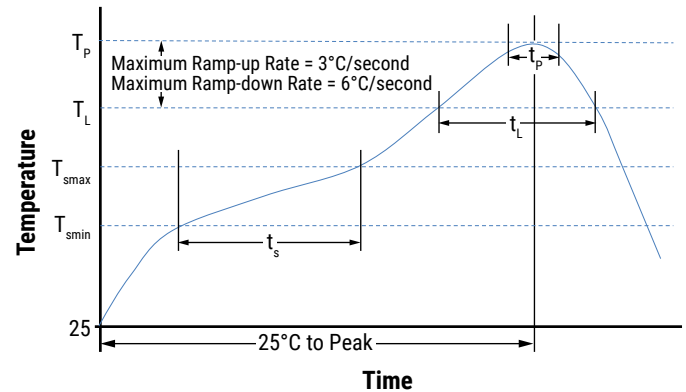

Note: All temperatures refer to the center of the package, measured on the capacitor body surface that is facing up during assembly reflow.

Hand Soldering and Removal of KONNEKT Capacitors

The preferred method of attachment for KEMET's KONNEKT Capacitors is IR or convection reflow where temperature, time and air flow are well controlled.

However, it is understood that the manual attachment of KONNEKT capacitors is necessary for prototype and lab testing. In these instances, care must be taken not to introduce excessive temperature gradients in the KONNEKT part type that may lead to cracking in the ceramic or separation of the TLPS material.

[Please see KEMET's KONNEKT Soldering Guidelines here.](#)

Storage & Handling

Ceramic chip capacitors should be stored in normal working environments. While the chips themselves are quite robust in other environments, solderability will be degraded by exposure to high temperatures, high humidity, corrosive atmospheres, and long term storage. In addition, packaging materials will be degraded by high temperature – reels may soften or warp and tape peel force may increase. KEMET recommends that maximum storage temperature not exceed 40°C and maximum storage humidity not exceed 70% relative humidity. In addition, temperature fluctuations should be minimized to avoid condensation on the parts and atmospheres should be free of chlorine and sulfur bearing compounds. For optimized solderability chip stock should be used promptly, preferably within 1.5 years upon receipt.

Construction

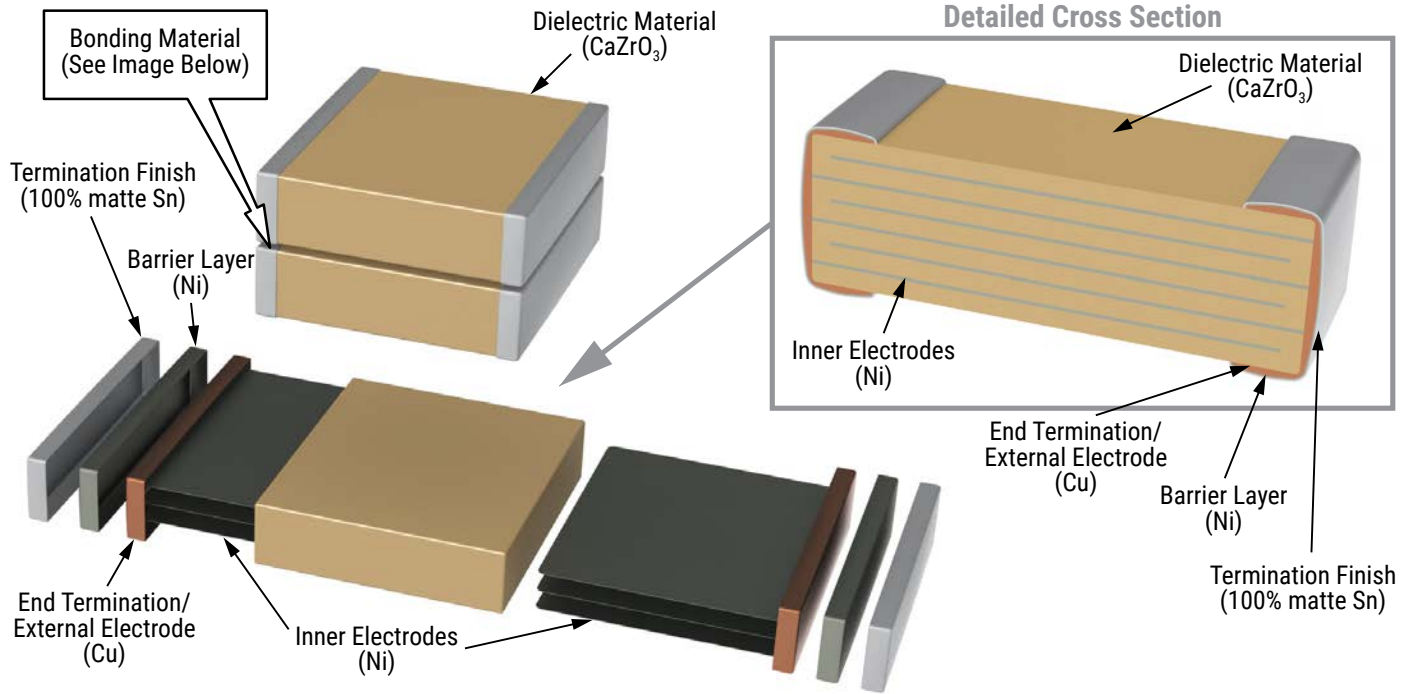

Bonding Material

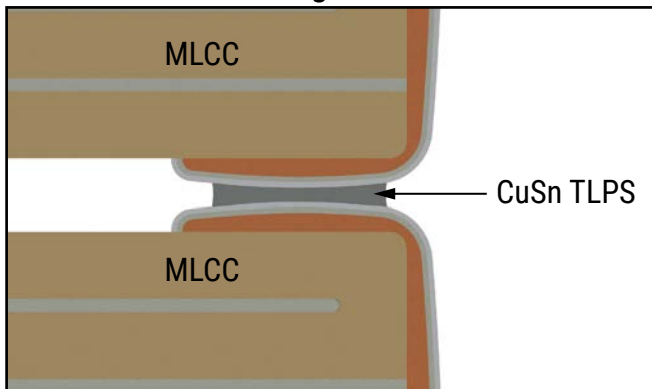

Tape & Reel Packaging Information

KEMET offers multilayer ceramic chip capacitors packaged in 8, 12, 16 and 24 mm tape on 7" and 13" reels in accordance with EIA Standard 481. This packaging system is compatible with all tape-fed automatic pick and place systems. See Table 1B for details on reeling quantities for commercial chips.

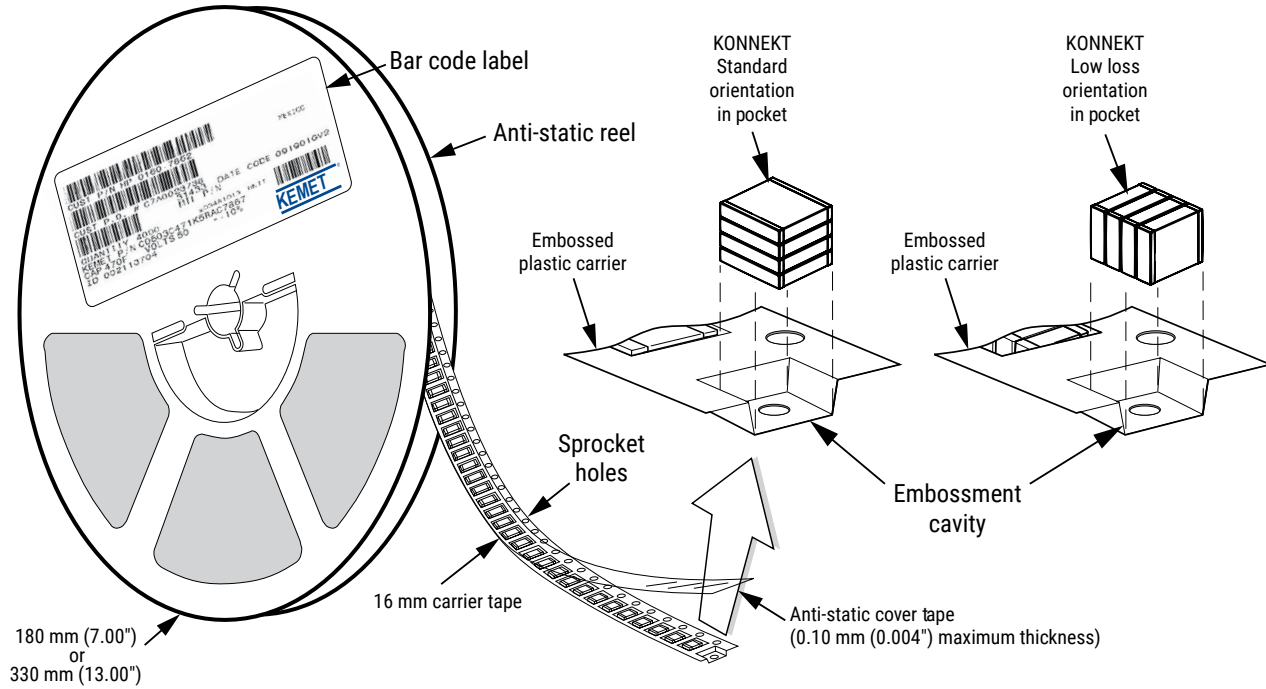

Table 4 – Carrier Tape Configuration, Embossed Plastic (mm)

EIA Case Size	Chip Number	Tape Size (W)*	Embossed Plastic	
			7" Reel	13" Reel
			Pitch (P ₁) ²	
KONNEKT 3640	2	24	20	20
	3		20	20
	4		24	24

1. Refer to Figures 1 and 2 for W and P₁ carrier tape reference locations.
2. Refer to Tables 4 and 5 for tolerance specifications.

Figure 1 – Embossed (Plastic) Carrier Tape Dimensions

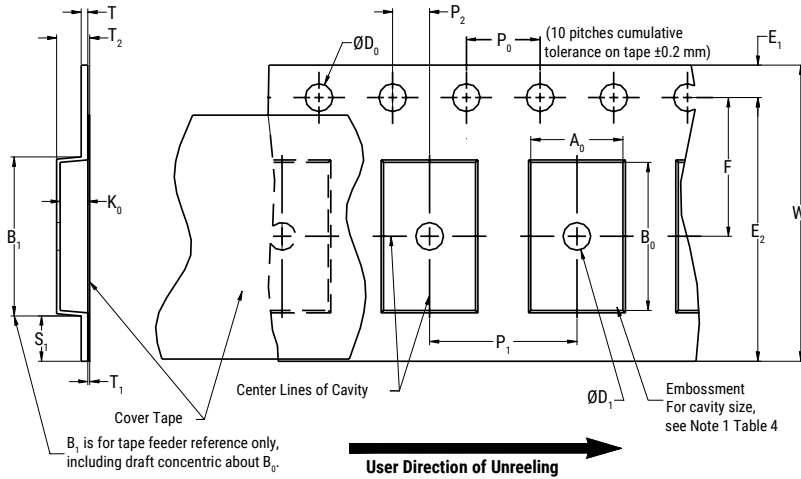

Table 5 – Embossed (Plastic) Carrier Tape Dimensions

Metric will govern

Constant Dimensions – Millimeters (Inches)									
Tape Size	D ₀	D ₁ Minimum Note 1	E ₁	P ₀	P ₂	R Reference Note 2	S ₁ Minimum Note 3	T Maximum	T ₁ Maximum
24 mm	1.5 +0.10/-0.0 (0.059 +0.004/-0.0)	1.5 (0.059)	1.75±0.10 (0.069±0.004)	4.0±0.10 (0.157±0.004)	2.0±0.05 (0.079±0.002)	30 (1.181)	0.600 (0.024)	0.600 (0.024)	0.100 (0.004)

Variable Dimensions – Millimeters (Inches)									
Number of Chips	Tape Size	Pitch	B ₁ Maximum Note 4	E ₂ Minimum	F	P ₁	T ₂ Maximum	W Maximum	A ₀ , B ₀ & K ₀
2,3	24 mm	20mm	12.1 (0.476)	22.25 (0.875)	11.5+/-0.10 (0.452±0.004)	20.0±0.10 (0.787±0.004)	11.2 (0.441)	24.3 (0.957)	Note 5
4		24mm				24.0±0.10 (0.944±0.004)			

1. The embossment hole location shall be measured from the sprocket hole controlling the location of the embossment. Dimensions of embossment location and hole location shall be applied independent of each other.
2. The tape with or without components shall pass around R without damage (see Figure 6).
3. If S₁ < 1.0 mm, there may not be enough area for cover tape to be properly applied (see EIA Document 481 paragraph 4.3 (b)).
4. B₁ dimension is a reference dimension for tape feeder clearance only.
5. The cavity defined by A₀, B₀ and K₀ shall surround the component with sufficient clearance that:
 - (a) the component does not protrude above the top surface of the carrier tape.
 - (b) the component can be removed from the cavity in a vertical direction without mechanical restriction, after the top cover tape has been removed.
 - (c) rotation of the component is limited to 20° maximum for 8 and 12 mm tapes and 10° maximum for 16 mm tapes (see Figure 3).
 - (d) lateral movement of the component is restricted to 0.5 mm maximum for 8 mm and 12 mm wide tape and to 1.0 mm maximum for 16 mm tape (see Figure 4)
 - (e) For KPS Series product, A₀ and B₀ are measured on a plane 0.3 mm above the bottom of the pocket.
 - (f) see Addendum in EIA Document 481 for standards relating to more precise taping requirements.

Packaging Information Performance Notes

- 1. Cover Tape Break Force:** 1.0 kg minimum.
- 2. Cover Tape Peel Strength:** The total peel strength of the cover tape from the carrier tape shall be:

Tape Width	Peel Strength
24 mm	0.1 to 1.6 newton (10 to 160 gf)

The direction of the pull shall be opposite the direction of the carrier tape travel. The pull angle of the carrier tape shall be 165° to 180° from the plane of the carrier tape. During peeling, the carrier and/or cover tape shall be pulled at a velocity of 300±10 mm/minute.

- 3. Labeling:** Bar code labeling (standard or custom) shall be on the side of the reel opposite the sprocket holes. Refer to EIA Standards 556 and 624.

Figure 2 – Maximum Component Rotation

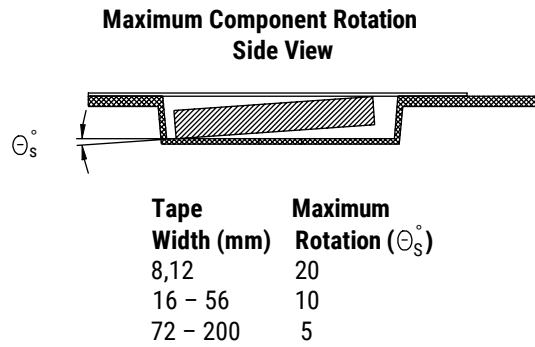
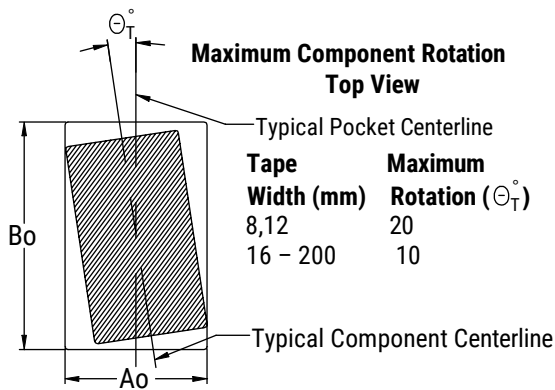

Figure 3 – Maximum Lateral Movement

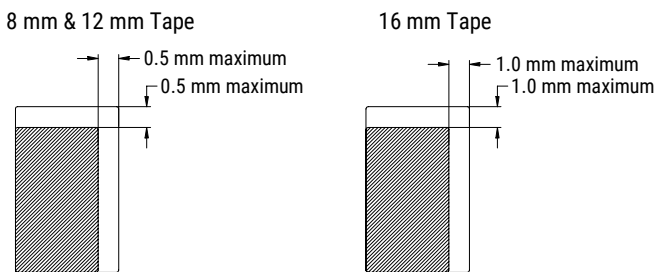

Figure 4 – Bending Radius

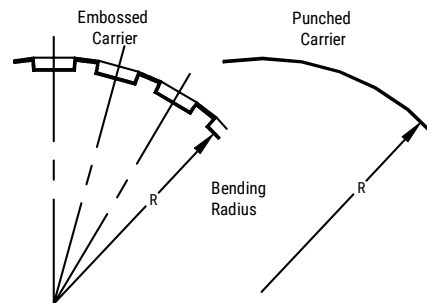
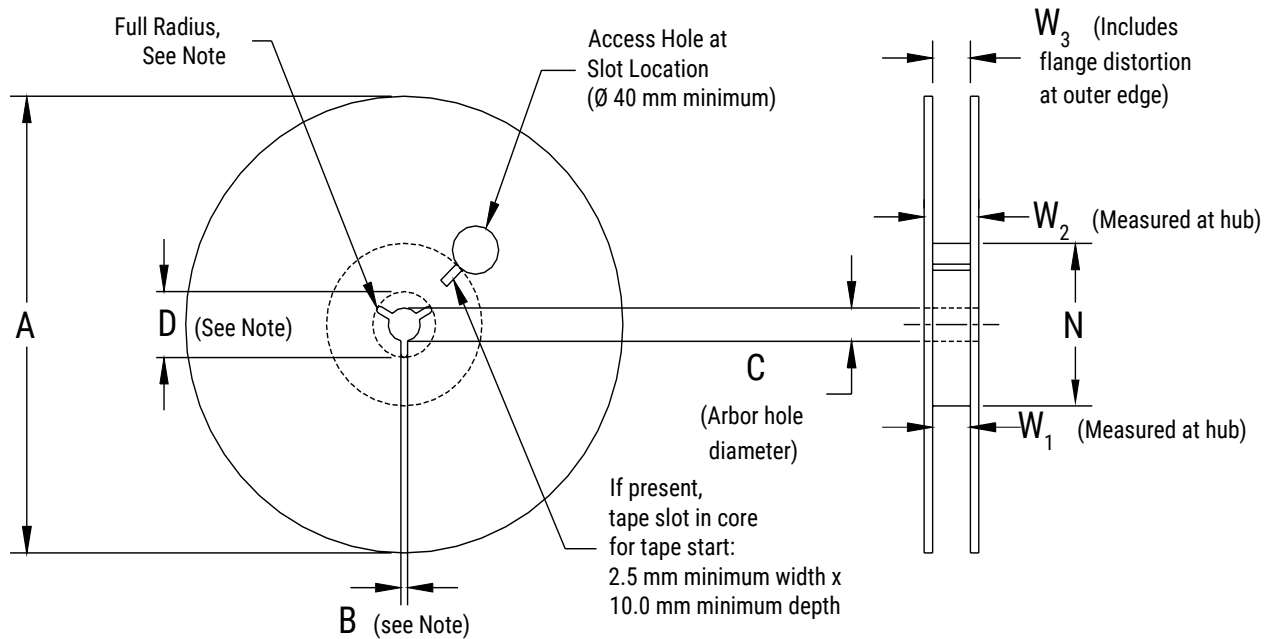

Figure 5 – Reel Dimensions



Note: Drive spokes optional; if used, dimensions B and D shall apply.

Table 6 – Reel Dimensions

Metric will govern

Constant Dimensions – Millimeters (Inches)				
Tape Size	A	B Minimum	C	D Minimum
24 mm	178±0.20 (7.008±0.008) or 330±0.20 (13.000±0.008)	1.5 (0.059)	13.0+0.5/-0.2 (0.521+0.02/-0.008)	20.2 (0.795)
Variable Dimensions – Millimeters (Inches)				
Tape Size	N Minimum See Note 2, Tables 2-3	W_1	W_2 Maximum	W_3
24 mm	50 (1.969)	25+1.0/-0.0 (0.984+0.039/-0.0)	27.4+1.0/-1.0 (1.078+0.039/-0.039)	Shall accommodate tape width without interference

Figure 6 – Tape Leader & Trailer Dimensions

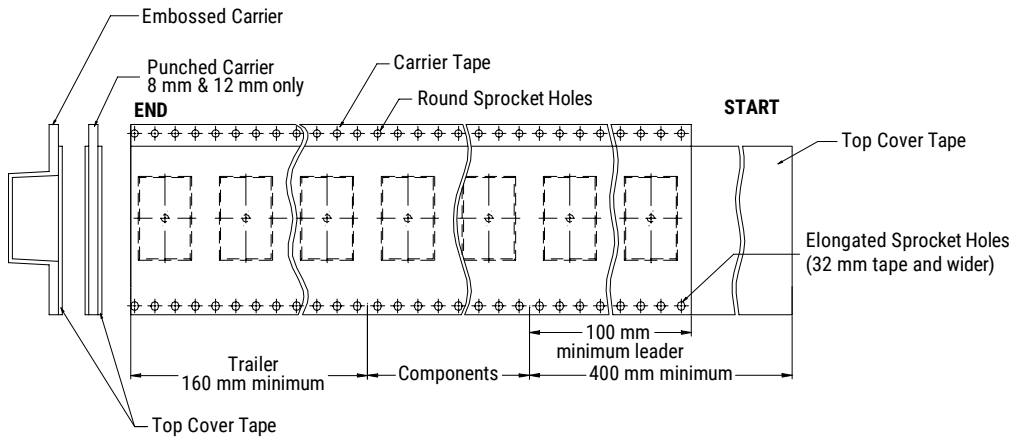
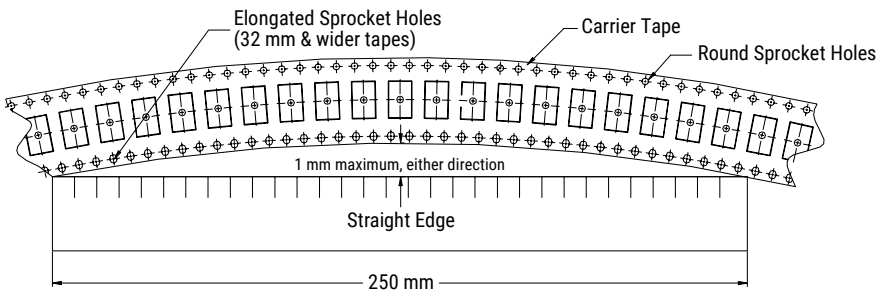

Figure 7 – Maximum Camber



KEMET Electronics Corporation Sales Offices

For a complete list of our global sales offices, please visit www.kemet.com/sales.

Disclaimer

All product specifications, statements, information and data (collectively, the "Information") in this datasheet are subject to change. The customer is responsible for checking and verifying the extent to which the Information contained in this publication is applicable to an order at the time the order is placed. All Information given herein is believed to be accurate and reliable, but it is presented without guarantee, warranty, or responsibility of any kind, expressed or implied.

Statements of suitability for certain applications are based on KEMET Electronics Corporation's ("KEMET") knowledge of typical operating conditions for such applications, but are not intended to constitute – and KEMET specifically disclaims – any warranty concerning suitability for a specific customer application or use. The Information is intended for use only by customers who have the requisite experience and capability to determine the correct products for their application. Any technical advice inferred from this Information or otherwise provided by KEMET with reference to the use of KEMET's products is given gratis, and KEMET assumes no obligation or liability for the advice given or results obtained.

Although KEMET designs and manufactures its products to the most stringent quality and safety standards, given the current state of the art, isolated component failures may still occur. Accordingly, customer applications which require a high degree of reliability or safety should employ suitable designs or other safeguards (such as installation of protective circuitry or redundancies) in order to ensure that the failure of an electrical component does not result in a risk of personal injury or property damage.

Although all product-related warnings, cautions and notes must be observed, the customer should not assume that all safety measures are indicated or that other measures may not be required.

KEMET is a registered trademark of KEMET Electronics Corporation.

X-ON Electronics

Largest Supplier of Electrical and Electronic Components

Click to view similar products for [Multilayer Ceramic Capacitors MLCC - SMD/SMT](#) category:

Click to view products by [Kemet](#) manufacturer:

Other Similar products are found below :

[D55342E07B523DR-T/R](#) [NCA1206X7R103K50TRPF](#) [NCA1206X7R104K16TRPF](#) [NIN-FB391JTRF](#) [NIN-FC2R7JTRF](#)
[NMC0402NPO220J50TRPF](#) [NMC0402X5R105K6.3TRPF](#) [NMC0402X5R224K6.3TRPF](#) [NMC0402X7R103J25TRPF](#)
[NMC0402X7R153K16TRPF](#) [NMC0603NPO201J50TRPF](#) [NMC0603NPO330G50TRPF](#) [NMC0603NPO331F50TRPF](#)
[NMC0603X5R475M6.3TRPF](#) [NMC0805NPO220J100TRPF](#) [NMC0805NPO270J50TRPF](#) [NMC0805NPO681F50TRPF](#)
[NMC0805NPO820J50TRPF](#) [NMC0805X7R224K25TRPF](#) [NMC1206NPO150J50TRPF](#) [NMC1210Y5V105Z50TRPLPF](#) [NMC-](#)
[L0402NPO7R0C50TRPF](#) [NMC-L0603NPO2R2B50TRPF](#) [NMC-Q0402NPO8R2D200TRPF](#) [C1206C101J1GAC](#) [C1608C0G2A221J](#)
[C1608X7R1E334K](#) [C2012C0G2A472J](#) [2220J2K00562KXT](#) [KHC201E225M76N0T00](#) [1812J2K00332KXT](#) [CDR14BP471CJUR](#)
[CDR31BX103AKWR](#) [CDR33BX683AKUS](#) [CGA2B2C0G1H010C](#) [CGA2B2C0G1H040C](#) [CGA2B2C0G1H050C](#) [CGA2B2C0G1H060D](#)
[CGA2B2C0G1H070D](#) [CGA2B2C0G1H120J](#) [CGA2B2C0G1H151J](#) [CGA2B2C0G1H1R5C](#) [CGA2B2C0G1H2R2C](#) [CGA2B2C0G1H390J](#)
[CGA2B2C0G1H391J](#) [CGA2B2C0G1H3R3C](#) [CGA2B2C0G1H680J](#) [CGA2B2C0G1H6R8D](#) [CGA2B2C0G1H820J](#) [CGA2B2X8R1H152K](#)