

Overview

The T370 and T378 Micron MIL-PRF-49137/6 (CX06 Style) capacitors are available in a variety of case styles and sizes. These capacitors are designed to operate from -55°C to $+85^{\circ}\text{C}$ at full voltage and to $+125^{\circ}\text{C}$ with derating. The KEMET Micron is qualified under MIL-PRF-49137/6 as military styles CX06 (T378).

The T370 capacitor is encapsulated in a molded, gold-colored epoxy. This encasement technique allows maximum utilization of circuit board real estate, with precisely centered leads in a microminiature case.

These molded packages also provide significant improvements in overall dimensional consistency, as well as lead wires precisely spaced to within 0.010 inches (0.25 mm). With KEMET's new molded packaging design, these capacitors can now be marked using a laser printing technique. The KEMET laser marking system ensures legibility and permanency while offering a complete alphanumeric print format. Laser print meets all requirements of the Resistance to Solvents Test, Method 215 of MIL-STD-202.

Benefits

- Taped and reeled per EIA Specification RS-468
- Laser-marked case
- Qualified to MIL-PRF-49137/6, Style CX06 (T378 only)
- T370 capacitance values of 0.68 – 220 μF
- T378 capacitance values of 2.2 – 220 μF
- Tolerances of +40% -20%, $\pm 5\%$, $\pm 10\%$ and $\pm 20\%$ standard
- Voltage rating of 3 – 35 VDC
- Operating temperature range of -55°C to $+85^{\circ}\text{C}$ at rated voltage and up to 125°C with derating
- Case sizes: C, D, E, F

Applications

Typical applications include use in bypass, coupling, filtering, and timing circuits.

T370

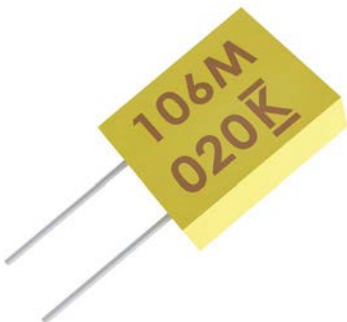

T378

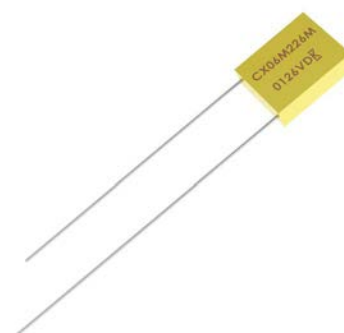

Ordering Information – T370/T378

T	37X	D	475	M	035	A	S	
Capacitor Class	Series	Case Size	Capacitance Code (pF)	Capacitance Tolerance	Rated Voltage (VDC)	Failure Rate	Termination Finish	Packaging
T = Tantalum	370 378	C, D, E, F	First two digits represent significant figures. Third digit specifies number of zeros to follow.	M = ±20% K = ±10% J = ±5% L = 40%, -20%	003 = 3 004 = 4 006 = 6.3 010 = 10 015 = 15 020 = 20 025 = 25 035 = 35	Not Applicable	S = Standard (solder-coated nickel)	Blank = Bulk 7301 = Tape & Reel 7305 = Ammo 7317 = Ammo

Ordering Information – Defense MIL-PRF-49137/6 (CX06 Style)

CX	06	D	335	K
Type	Style	Voltage	Capacitance Code (pF)	Capacitance Tolerance
Fixed, solid tantalum, polar, nonhermetically sealed capacitors.	06-T378 (Radial leads)	B = 3 V C = 4 V D = 6 V F = 10 V H = 15 V J = 20 V K = 25 V M = 35 V	First two digits represent significant figures. Third digit specifies number of zeros to follow.	M = ±20% K = ±10%

Performance Characteristics

Item	Performance Characteristics
Operating Temperature	-55°C to 125°C
Rated Capacitance Range	T370: 0.68 – 220 µF at 120 Hz/25°C; T378: 2.2 – 220 µF at 120 Hz/25°C
Capacitance Tolerance	M tolerance ±20% standard, L tolerance + 40%/-20%, J tolerance ±5%, K tolerance ±10%
Rated Voltage Range	3 – 35 V
DF (120 Hz at 25°C)	Refer to Part Number Electrical Specification Table
Leakage Current	Refer to Part Number Electrical Specification Table (rated voltage up to +85°C and 2/3 of rated voltage applied at 125°C)

Dimensions – Millimeters (Inches)

Metric will govern

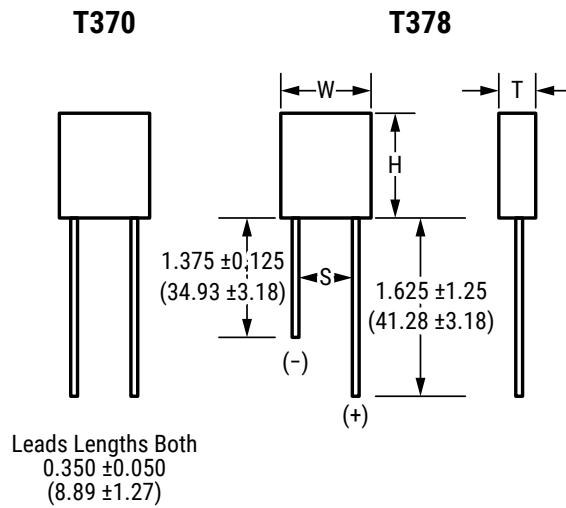

Case Size	H (MAXIMUM)	W (MAXIMUM)	T (MAXIMUM)	S Lead Spacing ± 0.010 (± 0.25)	D Lead Diameter ± 0.001 (± 0.03)
C	0.225 (5.72)	0.185 (4.7)	0.075 (1.91)	0.150 (3.81)	0.016 (0.41)
D	0.290 (7.37)	0.220 (5.59)	0.110 (2.79)	0.180 (4.57)	0.016 (0.41)
E	0.310 (7.87)	0.230 (5.84)	0.130 (3.30)	0.200 (5.08)	0.016 (0.41)
F	0.475 (12.07)	0.375 (9.53)	0.150 (3.81)	0.300 (7.62)	0.016 (0.41)

Table 1 – Ratings & Part Number Reference

Rated Voltage	Rated Capacitance	Case Code Case Size	KEMET Part Number	DC Leakage	DF % at 25°C	CX06 CAPACITORS PER MIL-PRF-49137/6	
						CX06 MILITARY PART NUMBER	KEMET MILITARY PART NUMBER
(V) 85°C	µF			µA at 25°C Maximum/5 Minutes	120 Hz Maximum		
3	220.0	F	T370F227(1)003AS	9.0	15	CX06B227(2)	T378F227(3)003AS
4	15.0	C	T370C156(1)004AS	1.0	8.0	CX06C156(2)	T378C156(3)004AS
4	47.0	D	T370D476(1)004AS	2.0	8.0	CX06C476(2)	T378D476(3)004AS
4	68.0	E	T370E686(1)004AS	3.0	8.0	CX06C686(2)	T378E686(3)004AS
6	10.0	C	T370C106(1)006AS	1.0	6.0	CX06D106(2)	T378C106(3)006AS
6	33.0	D	T370D336(1)006AS	2.0	6.0	CX06D336(2)	T378D336(3)006AS
6	47.0	E	T370E476(1)006AS	3.0	6.0	CX06D476(2)	T378E476(3)006AS
6	150.0	F	T370F157(1)006AS	9.0	10.0	CX06D157(2)	T378F157(3)006AS
10	6.8	C	T370C685(1)010AS	1.0	6.0	CX06F685(2)	T378C685(3)010AS
10	22.0	D	T370D226(1)010AS	2.0	6.0	CX06F226(2)	T378D226(3)010AS
10	33.0	E	T370E336(1)010AS	3.0	6.0	CX06F336(2)	T378E336(3)010AS
10	100.0	F	T370F107(1)010AS	9.0	8.0	CX06F107(2)	T378F107(3)010AS
15	15.0	D	T370D156(1)015AS	2.0	6.0	CX06H156(2)	T378D156(3)015AS
15	22.0	E	T370E226(1)015AS	3.0	6.0	CX06H226(2)	T378E226(3)015AS
15	68.0	F	T370F686(1)015AS	9.0	8.0	CX06H686(2)	T378F686(3)015AS
20	3.3	C	T370C335(1)020AS	1.0	6.0	CX06J335(2)	T378C335(3)020AS
20	4.7	C	T370C475(1)020AS	1.0	6.0	CX06J475(2)	T378C475(3)020AS
20	10.0	D	T370D106(1)020AS	2.0	6.0	CX06J106(2)	T378D106(3)020AS
20	15.0	E	T370E156(1)020AS	3.0	6.0	CX06J156(2)	T378E156(3)020AS
20	47.0	F	T370F476(1)020AS	9.0	8.0	CX06J476(2)	T378F476(3)020AS
25	2.2	C	T370C225(1)025AS	1.0	6.0	CX06K225(2)	T378C225(3)025AS
25	6.8	D	T370D685(1)025AS	2.0	6.0	CX06K685(2)	T378D685(3)025AS
25	10.0	E	T370E106(1)025AS	3.0	6.0	CX06K106(2)	T378E106(3)025AS
25	33.0	F	T370F336(1)025AS	9.0	6.0	CX06K336(2)	T378F336(3)025AS
35	0.68	C	T370C684(1)035AS	1.0	6.0	CX06M684(2)	T378C684(3)035AS
35	1.0	C	T370C105(1)035AS	1.0	6.0	CX06M105(2)	T378C105(3)035AS
35	1.5	C	T370C155(1)035AS	1.0	6.0	CX06M155(2)	T378C155(3)035AS
35	2.2	D	T370D225(1)035AS	2.0	6.0	CX06M225(2)	T378D225(3)035AS
35	3.3	D	T370D335(1)035AS	2.0	6.0	CX06M335(2)	T378D335(3)035AS
35	4.7	D	T370D475(1)035AS	2.0	6.0	CX06M475(2)	T378D475(3)035AS
35	6.8	E	T370E685(1)035AS	3.0	6.0	CX06M685(2)	T378E685(3)035AS
35	10.0	F	T370F106(1)035AS	9.0	6.0	CX06M106(2)	T378F106(3)035AS
35	15.0	F	T370F156(1)035AS	9.0	6.0	CX06M156(2)	T378F156(3)035AS
35	22.0	F	T370F226(1)035AS	9.0	6.0	CX06M226(2)	T378F226(3)035AS
(V) 85°C	µF	Case Size Code	µA at 25°C Maximum/5 Minutes	120 Hz Maximum	Ω at 25°C 100 kHz Max	B (0.1)	C (0.01)
Rated Voltage	Rated Capacitance		DC Leakage	DF % at 25°C	ESR	MIL-PRF-39003 (CSS13 Style)	

(1) To complete KEMET part number, insert L - +40%, -20%; M - 20%; K - ±10%; J - ±5%. Designates Capacitance tolerance.

(2) To complete military part number, insert M - ±20%, K - ±10%. Designates Capacitance tolerance.

(3) To complete KEMET part number, insert M - ±20%, K - ±10%. Designates Capacitance tolerance.

Recommended Voltage Derating Guidelines

	-55°C to 85°C	85°C to 125°C
% Change in Working DC Voltage with Temperature	V_R	66% of V_R

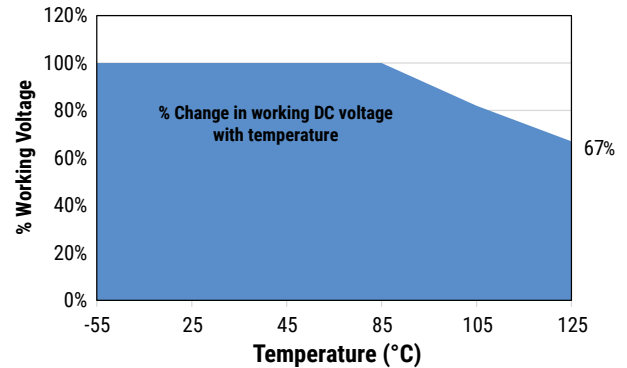

Ripple Current/Ripple Voltage

Permissible AC ripple voltage and current are related to equivalent series resistance (ESR) and the power dissipation capabilities of the device. Permissible AC ripple voltage that may be applied is limited by following criteria:

1. Dissipated power must not exceed the limits specified for the Series.
2. The positive peak AC voltage plus the DC bias voltage, if any, must not exceed the DC voltage rating of the capacitor.
3. The negative peak AC voltage in combination with bias voltage, if any, must not exceed the allowable limits specified for reverse voltage.

Thermal capacities for the various case sizes have been determined empirically and are listed below. The "ripple voltage" permissible may be calculated from the impedance and ESR data shown in the respective product section.

Temperature Compensation Multipliers for Maximum Power Dissipation		
$T \leq 25^\circ\text{C}$	$T \leq 85^\circ\text{C}$	$T \leq 125^\circ\text{C}$
1.00	0.90	0.40

T = Environmental temperature

The maximum power dissipation rating must be reduced with increasing environmental operating temperatures. Refer to the Temperature Compensation Multiplier table for details.

Case Size	Maximum Power Dissipation (P_{max}) Watts at 25°C
C	0.070
D	0.080
E	0.090
F	0.100

Using the P_{max} of the device, the maximum allowable rms ripple current or voltage may be determined.

$$I(max) = \sqrt{P_{max}/R}$$

$$E(max) = Z \sqrt{P_{max}/R}$$

I = rms ripple current (amperes)

E = rms ripple voltage (volts)

P_{max} = maximum power dissipation (watts)

R = ESR at specified frequency (ohms)

Z = Impedance at specified frequency (ohms)

Optimum Solder Wave Profile

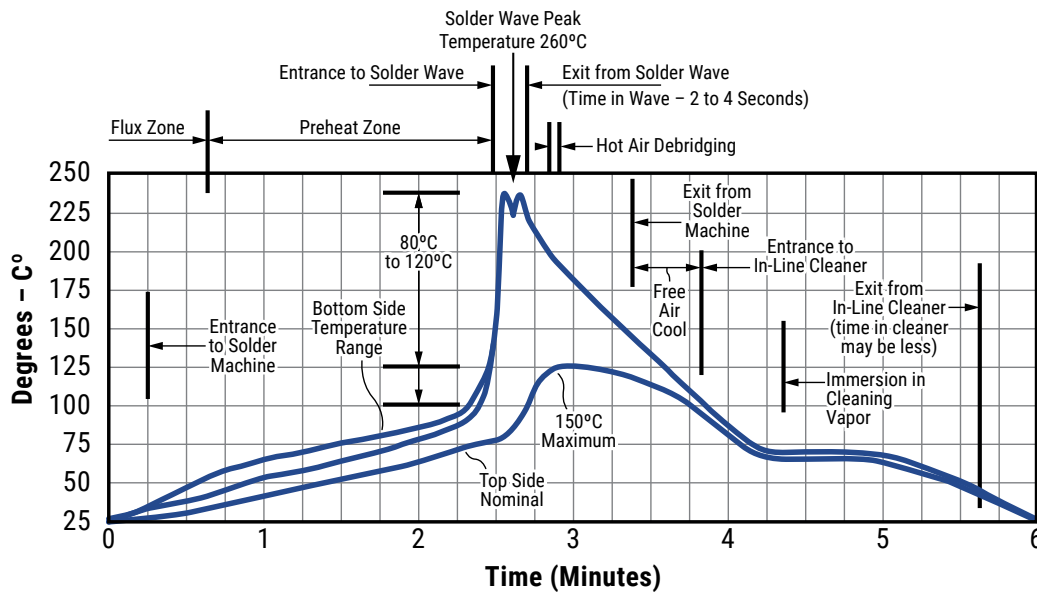

Reverse Voltage

Although these are polar capacitors, some degree of transient voltage reversal is permissible, as seen below. The capacitors should not be operated continuously in reverse mode, even within these limits.

Temperature	Percentage of Rated Voltage
+25°C	15
+85°C	5
+125°C	1

Mounting

All encased capacitors will pass the Resistance to Soldering Heat Test of MIL-STD-202, Method 210, Condition C. This test simulates wave solder of topside board mount product. This demonstration of resistance to solder heat is in accordance with what is believed to be the industry standard. More severe treatment must be considered reflective of an improper soldering process. The above figure is a recommended solder wave profile for both axial and radial leaded solid tantalum capacitors.

Capacitor Marking

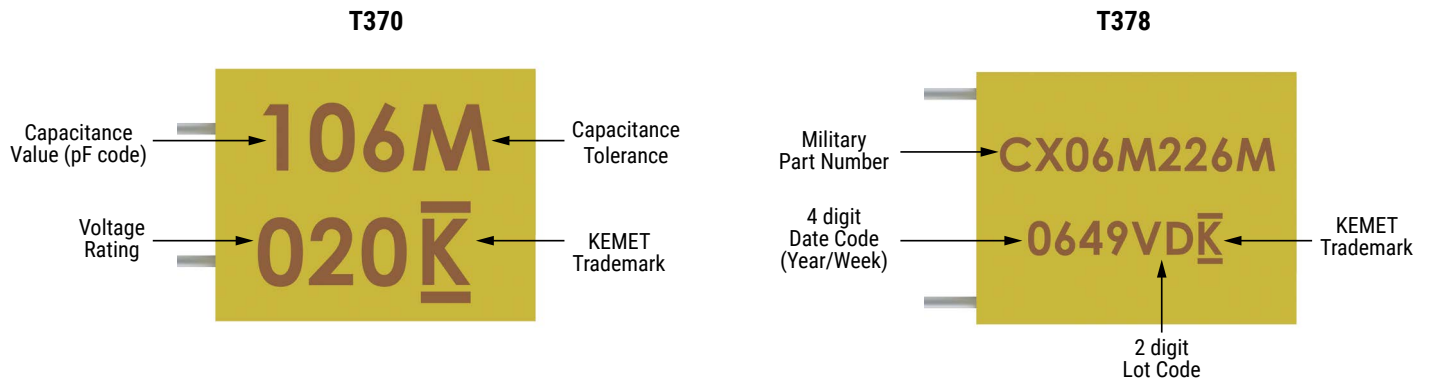

Storage

Tantalum molded radial/axial capacitors should be stored in normal working environments. KEMET recommends that maximum storage temperature not exceed 40°C and maximum storage humidity not exceed 60% RH. Storage at high temperature may cause a small, temporary increase in leakage current (measured under standard conditions), but the original value is usually restored within a few minutes after application of rated voltage. Storage at high humidity may increase capacitance and dissipation factor. Solderability will be degraded by exposure to high temperatures, high humidity, corrosive atmospheres, and long term storage. For optimized solderability capacitors stock should be used promptly, preferably within three years of receipt.

Tape & Reel Packaging Information

KEMET offers Solid Tantalum Capacitors fully compatible for use with automatic insertion machines for radial-lead components. Aris Reeling meets all requirements of EIA Standard RS-468. KEMET capacitors are wound on a precision made ARIS Reel Package. ARIS Ammo Package is also available.

Table 2 – Packaging Quantity

T370

Case Size	Standard Bulk Quantity	Standard Reel Quantity	Reel C-Spec
C	500	N/A	N/A
D	500	1,000	C-7301
E	500	1,000	C-7301
F	250	N/A	N/A

T378

Case Size	Standard Bulk Quantity	Standard Reel Quantity	Reel C-Spec
C	200	N/A	N/A
D	200	1,000	C-7301
E	180	1,000	C-7301
F	50	N/A	N/A

Figure 1

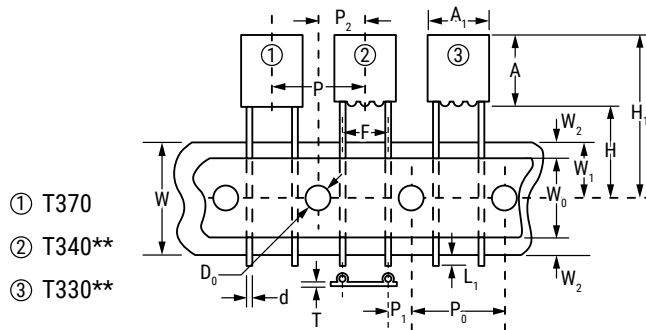

Dimension	Symbol	Nominal mm (inch)		Tolerance mm (inch)	
Body Height (1)	A	10.50 (0.413)		±0.38 (±0.015) Maximum	
Body Width (1)	A ₁	15.24 (0.600)		±0.38 (±0.015) Maximum	
Sprocket Hole Diameter	D ₀	4.0 (0.157)		±0.3 (±0.012)	
Lead Diameter	d	0.51 (0.020)	0.64 (0.025)	±0.05 (±0.001)	±0.03
Lead Center (5)	F	5.0 (0.197)	2.5 (0.098)	+0.8 (+0.032)	-0.2 (-0.008)
Component Base to Tape Center (2) (4) (6)	H	16.0 – 21.0 (0.630 – 0.827)		Reference Only	
Lead Standoff Height	H ₀	N/A			
Component Height Above Tape Center	H ₁	32.25 (1.270)		Maximum	
Component Alignment Front to Rear	ΔH	0		±2.0 (±0.079)	
Cut Out Length	L	11.0 (0.433)		Maximum	
Lead Protrusion	L ₁	2.0 (0.079)		Maximum	
Component Pitch (5)	P	12.7 (0.500)		±1.0 (±0.039)	
Sprocket Hole Pitch (3)	P ₀	12.7 (0.500)		±0.03 (±0.012)	
Sprocket Hole Center to Lead Center (4) (5)	P ₁	3.85 (0.152)	4.76 (0.188)	5.1 (0.201)	±0.7 (±0.028)
Sprocket Hole Center to Component Center	P ₂	6.35 (0.250)		±1.31 (±0.051)	
Body Thickness	T ₀	6.35 (0.250)		±1.3 Maximum	
Total Tape Thickness	T	0.7 (0.28)		±0.02 (±0.008)	
Carrier Tape Width	W	18.0 (0.709)		+1.0/-0.5 (+0.039/-0.020)	
Hold-Down Tape Width	W ₀	15 (0.561)	6 (0.236)	+1.0/-0.8 (+0.039/-0.031)	
Sprocket Hole Location	W ₁	9.0 (0.354)		+0.075/-0.5 (+0.030/-0.020)	
Hold-Down Tape Location	W ₂	3.0 (0.118)	12.0 (0.472)	Maximum	

Notes:

- (1) See Dimensions table for specific values per case size
- (2) Reference only
- (3) Cumulative pitch error ±1.0 mm (0.039") maximum in 20 consecutive sprocket hole locations.
- (4) Measured at bottom of standoff.
- (5) P, P₁ and F measured at egress from carrier tape.
- (6) H dimensions for T370 D and E 16.5mm ±0.5 mm (0.650" ±0.020")

On polar devices, the positive (+) lead exits from container first.

* Lead spacings are 2.5mm (0.098") center to center

** Lead spacings are 5.0mm (0.197") center to center.

KEMET Electronics Corporation Sales Offices

For a complete list of our global sales offices, please visit www.kemet.com/sales.

Disclaimer

All product specifications, statements, information and data (collectively, the "Information") in this datasheet are subject to change. The customer is responsible for checking and verifying the extent to which the Information contained in this publication is applicable to an order at the time the order is placed. All Information given herein is believed to be accurate and reliable, but it is presented without guarantee, warranty, or responsibility of any kind, expressed or implied.

Statements of suitability for certain applications are based on KEMET Electronics Corporation's ("KEMET") knowledge of typical operating conditions for such applications, but are not intended to constitute – and KEMET specifically disclaims – any warranty concerning suitability for a specific customer application or use. The Information is intended for use only by customers who have the requisite experience and capability to determine the correct products for their application. Any technical advice inferred from this Information or otherwise provided by KEMET with reference to the use of KEMET's products is given gratis, and KEMET assumes no obligation or liability for the advice given or results obtained.

Although KEMET designs and manufactures its products to the most stringent quality and safety standards, given the current state of the art, isolated component failures may still occur. Accordingly, customer applications which require a high degree of reliability or safety should employ suitable designs or other safeguards (such as installation of protective circuitry or redundancies) in order to ensure that the failure of an electrical component does not result in a risk of personal injury or property damage.

Although all product-related warnings, cautions and notes must be observed, the customer should not assume that all safety measures are indicated or that other measures may not be required.

KEMET is a registered trademark of KEMET Electronics Corporation.

X-ON Electronics

Largest Supplier of Electrical and Electronic Components

Click to view similar products for [Tantalum Capacitors - Solid Leaded](#) category:

Click to view products by [Kemet](#) manufacturer:

Other Similar products are found below :

[CX06M225M](#) [499D104X9035A1VE3](#) [CA55-C025M106T](#) [CA55-H6R3M337T](#) [CA55-D6R3M477T](#) [CA55-H004M477T](#) [CA55-H6R3M227T](#)
[CA55-D6R3M337T](#) [CA55-B010M476T](#) [CA55-B016M226T](#) [CA55-D025M336T](#) [CA55-H2R5M477T](#) [749DX335X9016A2](#) [F920J226MPA](#)
[M39003/01-6081](#) [CWR29JC476KCHC](#) [TAP105K035BRS](#) [TC-100/16](#) [TC-22/6.3](#) [TC-4.7/35](#) [TC-68/25](#) [TCA1E475M8R](#) [TCTU1D334M8R](#)
[150D127X9015S2B](#) [150D685X9100R2B](#) [150D276X9010B2B](#) [150D106X0015B2BE3](#) [150D126X9060S2BE3](#) [07016-092MCCA](#)
[550D476X9035S2T](#) [16TQS33MED](#) [173D336X0025Y](#) [489D226X0016D6VE3](#) [489D105X0025A6VE3](#) [489D106X0016C6VE3](#)
[489D106X0025D6VE3](#) [489D106X0035F1VE3](#) [489D224X0035A1VE3](#) [489D224X0035A6VE3](#) [489D475X0035D1VE3](#)
[489D475X0035D6VE3](#) [489D105X0025A1VE3](#) [489D106X0010B1VE3](#) [489D225X0025B1VE3](#) [790D686X9016C2BE3](#)
[790D226X9040C2BE3](#) [790D105X9040A2BE3](#) [790D106X9025B2BE3](#) [T110A105K050AS](#) [T110D227K010AS](#)