

**Overview**

The KEMET EA2/EB2 miniature signal relays offer a compact case size in a flat package. Minimal board space is consumed with either a through-hole or surface mount configuration. These relays are recognized by UL and CSA, while also being compliant with Part 68 of the FCC's 1,500 V surge capacity.

**Applications**

- Electronic switching systems
- PBX
- Terminal equipment
- Telephone systems

**Benefits**

- Low power consumption (< 200 mW)
- Compact and lightweight
- Low magnetic interference
- Breakdown voltage: 1,000 VAC (1,500 VAC surge), FCC Part 68 compliant
- Tube or embossed tape and reel packaging
- UL recognized (E73266) and CSA certified (LR46266)
- Surface mount and through-hole options

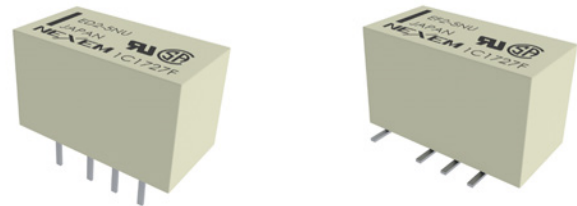

**Part Number System**

| <b>EB2-</b>                                       | <b>3</b>  | <b>S</b>   | <b>NU</b>                     | <b>-L</b>                                  |
|---|---|--|-------------------------------|--|
| Series  | Coil Voltage  | Latch Type   | Lead Type                     | Packaging                                  |
| EA2- = Through-hole mount<br>EB2- = Surface mount | 3 = 3 VDC<br>4.5 = 4.5 VDC<br>5 = 5 VDC<br>12 = 12 VDC<br>24 = 24 VDC | Blank = Non-latch type<br>S = Single coil latch type<br>T = Double coil latch type | NU = Standard<br>NJ = Trimmed | Blank = Tube<br>-L = Embossed tape on reel |

## Dimensions – Millimeters

### EA2 Series

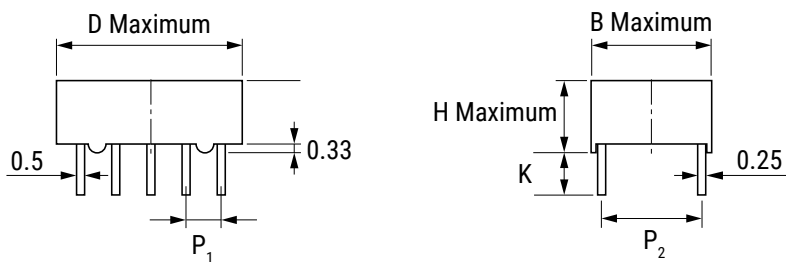

General tolerance:  $\pm 0.2$

### EB2 Series

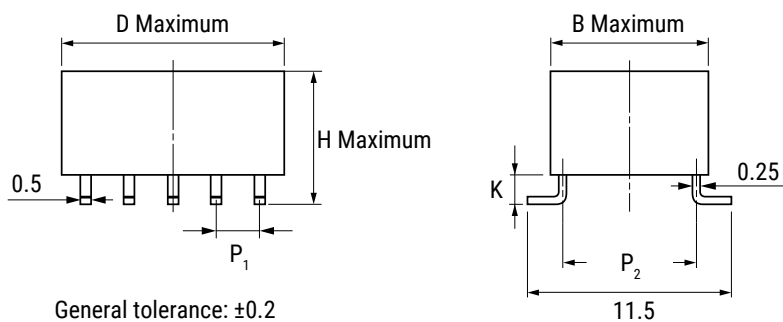

General tolerance:  $\pm 0.2$



| Series   | D    | H   | B   | P <sub>1</sub> | P <sub>2</sub> | K    |
|----------|------|-----|-----|----------------|----------------|------|
| EA2 (NU) | 14.2 | 5.4 | 9.2 | 2.54           | 7.62           | 3.5  |
| EA2 (NJ) | 14.2 | 5.4 | 9.2 | 2.54           | 7.62           | 2.8  |
| EB2      | 14.3 | 7.5 | 9.3 | 2.54           | 7.62           | 1.35 |

## Pin Configurations

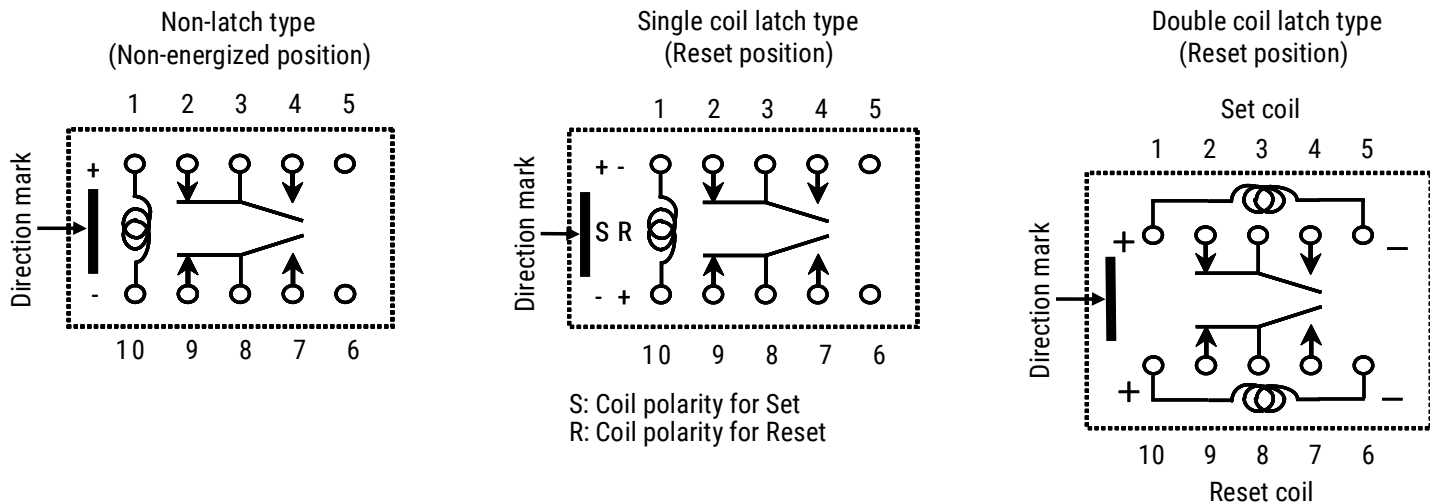
### Bottom view



## Safety Standards and Ratings

| Certification Body | Mark  | Specification                      | File Number | Rating  |
|--------------------|---|------------------------------------|-------------|---|
| UL                 |  | UL Recognized (UL508) <sup>1</sup> | E73266      | 30 VDC, 1 A (resistive)<br>110 VDC, 0.3 A (resistive)<br>125 VAC, 0.5 A (resistive) |
| CSA                |  | CSA Certified (CSA 22.2 #14)       | LR46266     |   |

<sup>1</sup> Spacing: UL114, UL478

## Environmental Compliance

All KEMET relays are RoHS Compliant.



**Table 1 – Ratings & Part Number Reference**

| Part Number               | Nominal Coil Voltage | Lead Type     | Packaging    |
|---------------------------|----------------------|---------------|--------------|
| ( ) Designates Latch Type | (VDC)                |               |              |
| EA2-3(1)NU                | 3.0                  | Radial        | Tube         |
| EA2-4.5(1)NU              | 4.5                  | Radial        | Tube         |
| EA2-5(1)NU                | 5.0                  | Radial        | Tube         |
| EA2-12(1)NU               | 12.0                 | Radial        | Tube         |
| EA2-24(1)NU               | 24.0                 | Radial        | Tube         |
| EA2-3(1)NJ                | 3.0                  | Radial        | Tube         |
| EA2-4.5(1)NJ              | 4.5                  | Radial        | Tube         |
| EA2-5(1)NJ                | 5.0                  | Radial        | Tube         |
| EA2-12(1)NJ               | 12.0                 | Radial        | Tube         |
| EA2-24(1)NJ               | 24.0                 | Radial        | Tube         |
| EB2-3(1)NU                | 3.0                  | Surface Mount | Tube         |
| EB2-4.5(1)NU              | 4.5                  | Surface Mount | Tube         |
| EB2-5(1)NU                | 5.0                  | Surface Mount | Tube         |
| EB2-12(1)NU               | 12.0                 | Surface Mount | Tube         |
| EB2-24(1)NU               | 24.0                 | Surface Mount | Tube         |
| EB2-3(1)NU-L              | 3.0                  | Surface Mount | Tape on Reel |
| EB2-4.5(1)NU-L            | 4.5                  | Surface Mount | Tape on Reel |
| EB2-5(1)NU-L              | 5.0                  | Surface Mount | Tape on Reel |
| EB2-12(1)NU-L             | 12.0                 | Surface Mount | Tape on Reel |
| EB2-24(1)NU-L             | 24.0                 | Surface Mount | Tape on Reel |
| Part Number               | Nominal Coil Voltage | Lead Type     | Packaging    |

(1) To complete KEMET part number, leave blank for Non-latch, insert S for Single coil, or T for Double coil. Designates latch type.

**Land Pattern – Millimeters**

**EA2 (bottom view)**

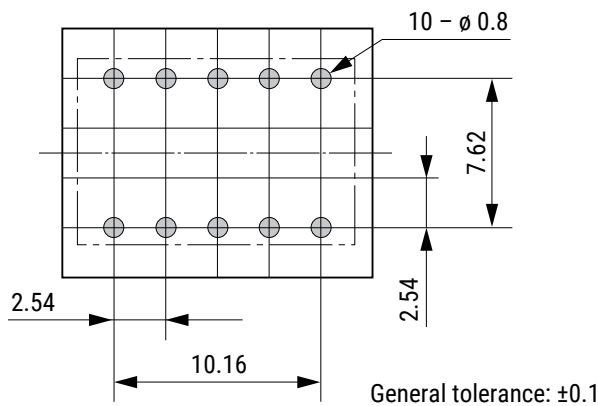

**EB2 (bottom view)**

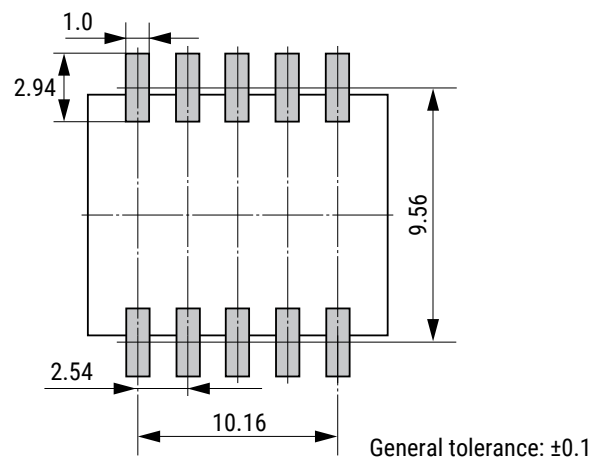

| Series       | V    | X    |
|--------------|------|------|
| EA2 (NU, NJ) | 7.62 | –    |
| EB2 (NU)     | 9.56 | 2.94 |

## Soldering Process

### EA2 – Through-hole Mounting

#### Automatic Soldering

Preheating: 110–120°C/110 seconds (maximum)

Solder temperature: 260°C maximum

Solder time: 5 seconds maximum

*Note: KEMET recommends cooling down a printed circuit board to less than 110°C within 40 seconds after soldering.*

#### Manual Soldering

Solder temperature: 350°C maximum

Solder time: 3 seconds maximum

### EB2 – Surface Mounting

#### IRS Method

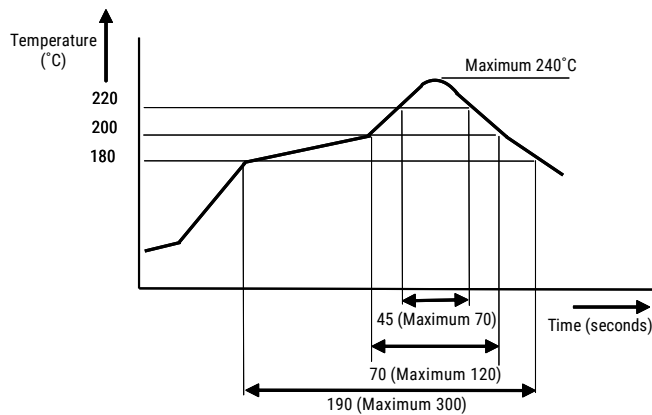

*Note: Temperature profile shows printed circuit board surface temperature on the relay terminal portion. Please consult KEMET if you wish to use a temperature profile other than above.*

## Contact Specifications

| Item                              |                           | EA2/EB2  |
|-----------------------------------|---------------------------|--|
| Contact Form                      |                           | 2 Form C   |
| Contact Material                  |                           | Silver alloy with gold alloy overlay   |
| Contact Ratings                   | Maximum Switching Power   | 30 W, 62.5 VA  |
|                                   | Maximum Switching Voltage | 220 VDC, 250 VAC   |
|                                   | Maximum Switching Current | 1 A  |
|                                   | Maximum Carrying Current  | 2 A  |
| Minimum Contact Ratings           |                           | 10 mVDC, 10 $\mu$ A <sup>*1</sup>  |
| Initial Contact Resistance        |                           | 75 m $\Omega$ maximum (initial)  |
| Operating Time (excluding bounce) |                           | Approximately 2 milliseconds   |
| Release Time (excluding bounce)   |                           | Approximately 1 millisecond  |
| Insulation Resistance             |                           | 1,000 M $\Omega$ at 500 VDC  |
| Withstand Voltage                 | Between Open Contacts     | 1,000 VAC (for one minute), 1,500 V surge (10 x 160 $\mu$ s) <sup>*2</sup>   |
|                                   | Between Adjacent Contacts | 1,000 VAC (for one minute), 1,500 V surge (10 x 160 $\mu$ s) <sup>*2</sup>   |
|                                   | Between Coil and Contacts | 1,000 VAC (for one minute), 1,500 V surge (10 x 160 $\mu$ s) <sup>*2</sup>   |
| Shock Resistance                  |                           | 735 m/s <sup>2</sup> (75 G) – misoperation<br>980 m/s <sup>2</sup> (100 G) – destructive failure   |
| Vibration Resistance              |                           | 10 to 55 Hz, double amplitude 3 mm (20 G) – misoperation<br>10 to 55 Hz, double amplitude 5 mm (30 G) – destructive failure                      |
| Ambient Temperature               |                           | -40 to +85°C   |
| Coil Temperature Rise             |                           | 18°C at nominal coil voltage (140 mW)  |
| Running Specifications            | Non-load                  | 1 x 10 <sup>8</sup> operations (Non-latch type) <sup>*3</sup><br>1 x 10 <sup>7</sup> operations (Latch type)                                     |
|                                   | Load                      | 50 VDC 0.1 A (resistive), 1 x 10 <sup>6</sup> operations at 85°C, 5 Hz<br>10 VDC 10 mA (resistive), 1 x 10 <sup>6</sup> operations at 85°C, 2 Hz |
| Weight                            |                           | Approximately 1.5 g  |

<sup>\*1</sup> This value is a reference value in the resistance load. Minimum capacity changes depending on the switching frequency, environment temperature, and load.

<sup>\*2</sup> Rise time: 10  $\mu$ s; decay time to half crest: 160  $\mu$ s.

<sup>\*3</sup> This shows the number of operations with fatal defects. Stable characteristics are maintained for 1 x 10<sup>7</sup> operations.

## Coil Specifications

| Non-latch Type (at 20°C)   |                                       |                                      |                                    |                              |
|----------------------------|---------------------------------------|--------------------------------------|------------------------------------|------------------------------|
| Nominal Coil Voltage (VDC) | Coil Resistance ( $\Omega$ $\pm$ 10%) | Operating Voltage <sup>1</sup> (VDC) | Release Voltage <sup>1</sup> (VDC) | Nominal Operating Power (mW) |
| 3                          | 64.3                                  | 2.25                                 | 0.3                                | 140                          |
| 4.5                        | 145                                   | 3.38                                 | 0.45                               | 140                          |
| 5                          | 178                                   | 3.75                                 | 0.5                                | 140                          |
| 12                         | 1028                                  | 9.0                                  | 1.2                                | 140                          |
| 24                         | 2880                                  | 18.0                                 | 2.4                                | 200                          |

<sup>1</sup> Test by pulse voltage.

## Coil Specifications cont.

| Single Coil Latch Type (at 20°C) <sup>2</sup> |                          |                                |                                  |                              |
|---|--------------------------|--------------------------------|----------------------------------|------------------------------|
| Nominal Coil Voltage (VDC)                    | Coil Resistance (Ω) ±10% | Set Voltage <sup>1</sup> (VDC) | Reset Voltage <sup>1</sup> (VDC) | Nominal Operating Power (mW) |
| 3   | 90                       | 2.25                           | 2.25                             | 100                          |
| 4.5   | 202.5                    | 3.38                           | 3.38                             | 100                          |
| 5   | 250                      | 3.75                           | 3.75                             | 100                          |
| 12  | 1440                     | 9.0                            | 9.0                              | 100                          |
| 24  | 3840                     | 18.0                           | 18.0                             | 150                          |

<sup>1</sup> Test by pulse voltage.

<sup>2</sup> Latch type relays should be initialized to a known position before using. Only the specified polarity should be used to energize the coil.

| Double Coil Latch Type (at 20°C) <sup>2,3</sup> |                          |      |                                |                                    |                              |
|---|--------------------------|------|--------------------------------|------------------------------------|------------------------------|
| Nominal Coil Voltage (VDC)                      | Coil Resistance (Ω) ±10% |      | Set Voltage <sup>4</sup> (VDC) | Release Voltage <sup>4</sup> (VDC) | Nominal Operating Power (mW) |
| 3   | S                        | 64.3 | 2.25                           | –                                  | 140                          |
|   | R                        | 64.3 | –                              | 2.25                               |                              |
| 4.5   | S                        | 145  | 3.38                           | –                                  | 140                          |
|   | R                        | 145  | –                              | 3.38                               |                              |
| 5   | S                        | 178  | 3.75                           | –                                  | 140                          |
|   | R                        | 178  | –                              | 3.75                               |                              |
| 12  | S                        | 1028 | 9.0                            | –                                  | 140                          |
|   | R                        | 1028 | –                              | 9.0                                |                              |
| 24  | S                        | 2880 | 18.0                           | –                                  | 200                          |
|   | R                        | 2880 | –                              | 18.0                               |                              |

<sup>2</sup> Latch type relays should be initialized to a known position before using. Only the specified polarity should be used to energize the coil.

<sup>3</sup> Can not be driven by reverse polarity for reverse operation.

<sup>4</sup> S = Set coil [pin #1 (+), pin #5 (-)], R = Reset coil [pin #10 (+), pin #6 (-)].

## Recommended Relay Drive Conditions

| Coil Type                  | Rating  | Ambient Temperature |
|----------------------------|---|---------------------|
| Non-latch                  | Voltage: $\leq \pm 5\%$ of nominal voltage  | -40 to +85°C        |
| Single Coil<br>Double Coil | Square pulse (rise and fall time is rapid)<br>Pulse height: $\leq \pm 5\%$ of nominal voltage<br>Pulse Width: > 10 ms |                     |

## Marking

### Top View

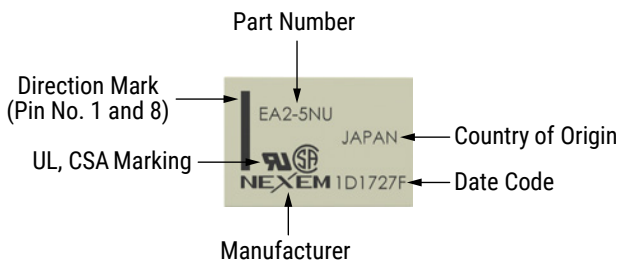



## Performance Data

### Coil Temperature Rise

Temperature is measured by coil resistance

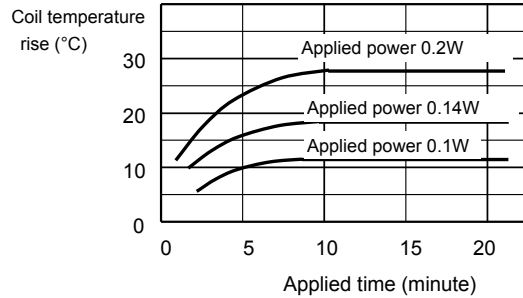
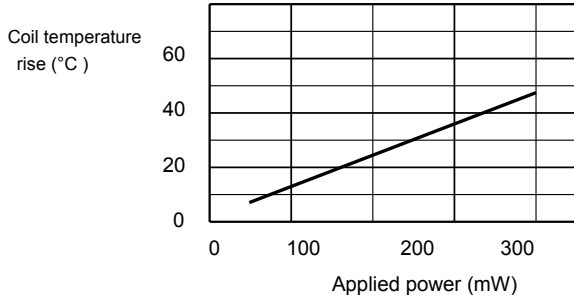

### Switching Capacity

Maximum Values

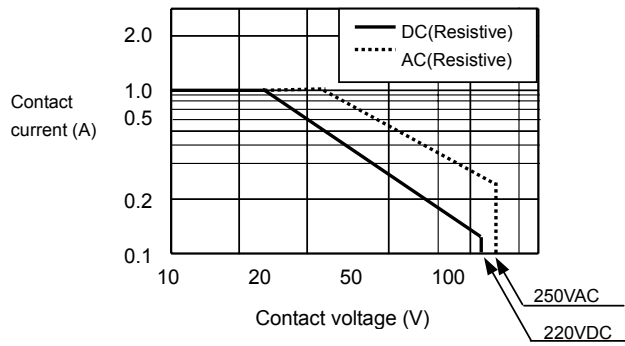

### Maximum Coil Voltage

Maximum value of permissible alteration

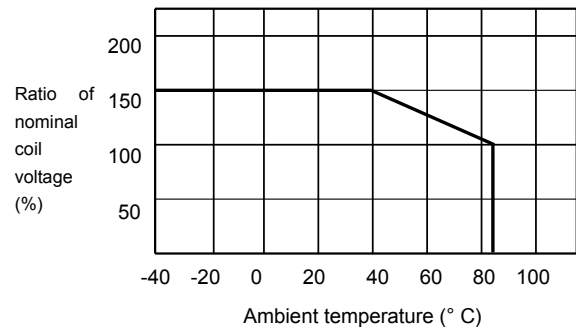

### Applied Voltage vs. Timing

(Sample: EA2-5NU)

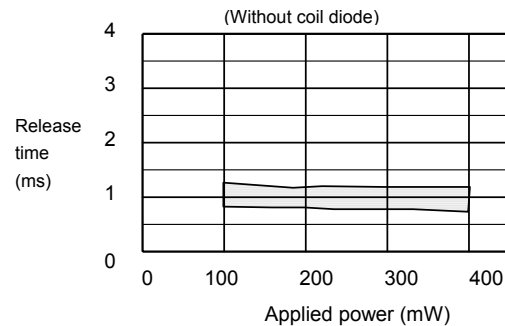
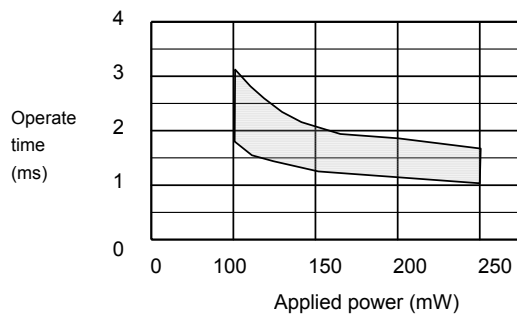

## Performance Data cont.

### Operate and Release Voltage vs. Ambient Temperature

This shows a typical change of operate (release) voltage. The value of must operate is estimated, so coil voltage must be applied higher than this value for safe operation. For hot start operation, please inquire with KEMET.

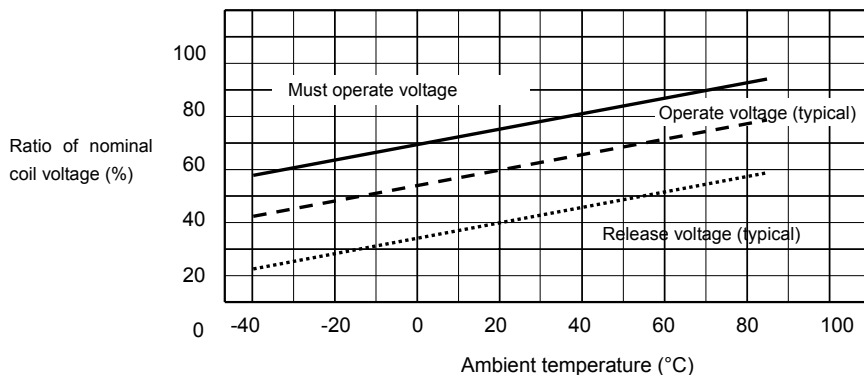

### Running Test (Non-load)

(Load: none; Drive: 5 VDC, 50 Hz, 50% duty; Ambient Temperature: room temperature; Sample: EA2-5NU, 20 pieces)

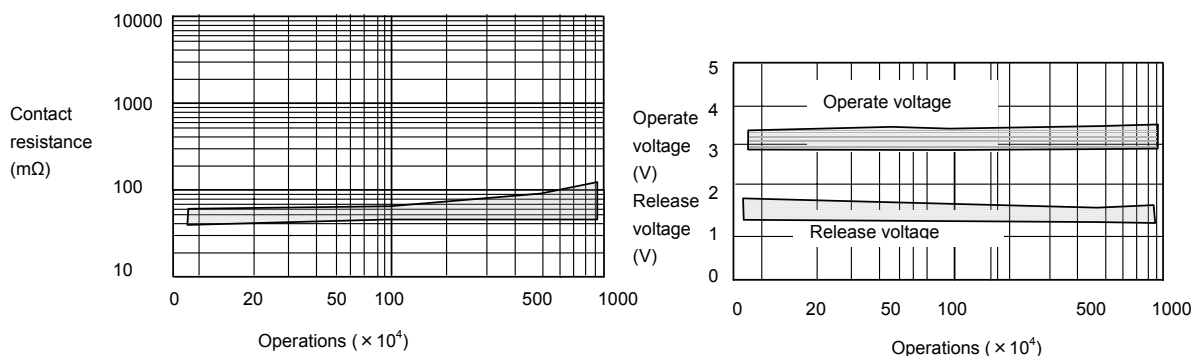

### Running Test (Load)

(Load: 50 VDC, 0.1 A resistive; Drive: 5 VDC, 5 Hz, 50% duty; Ambient Temperature: 85°C; Sample: EA2-5NU, 10 pieces)

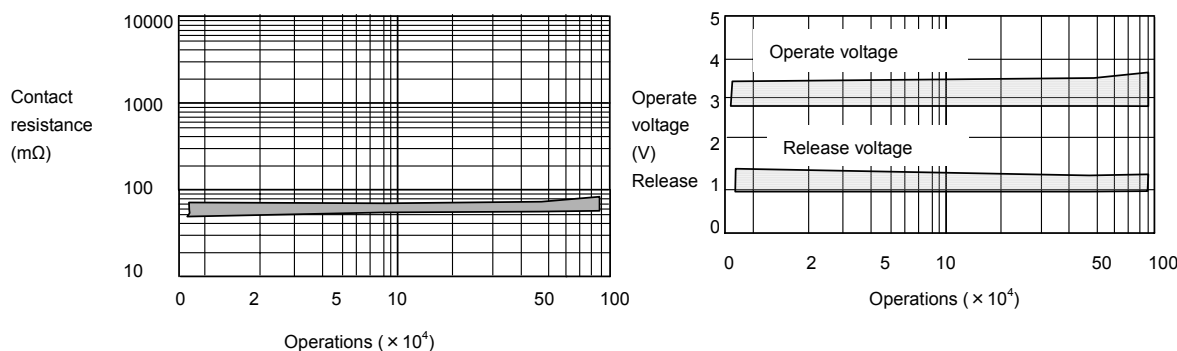

## Performance Data cont.

### Breakdown Voltage

(Sample: EA2-5NU, 10 pieces)

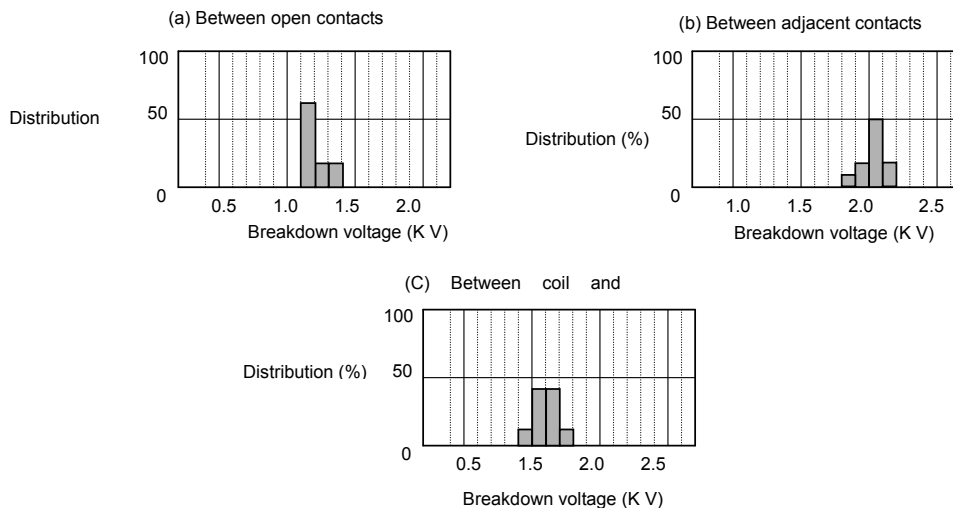

### Alteration of Voltage in Dense Mounting

(magnetic interference)

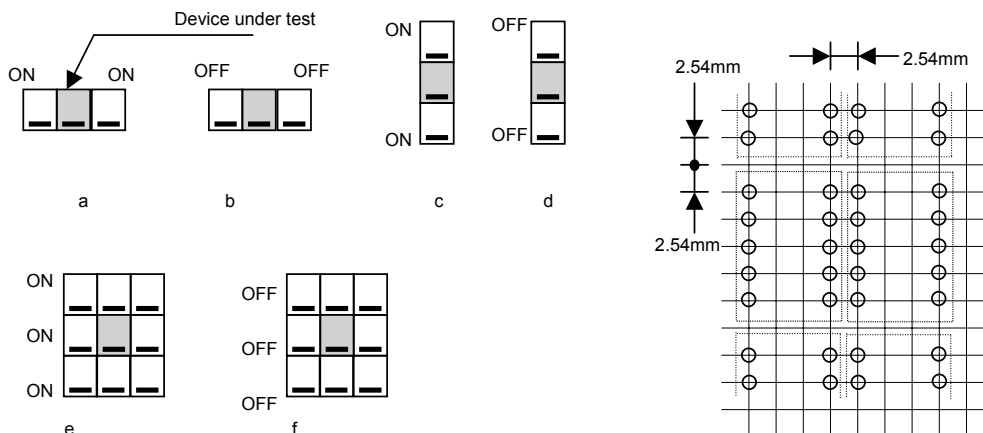
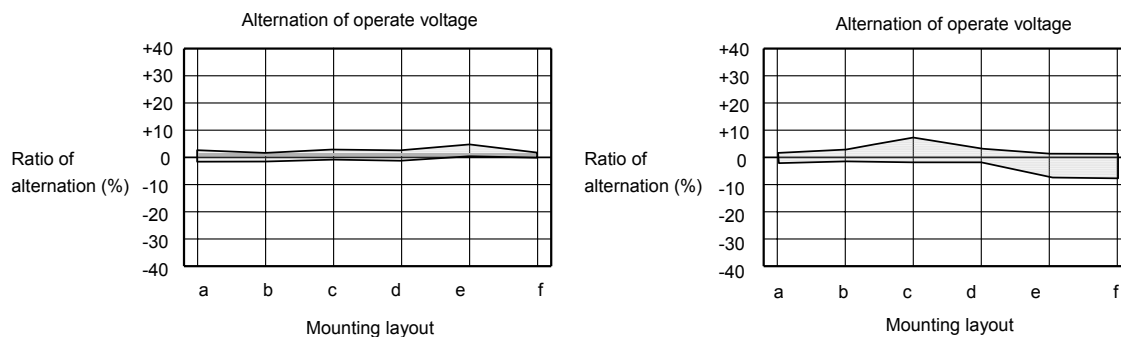

## Tube Packing – Millimeters

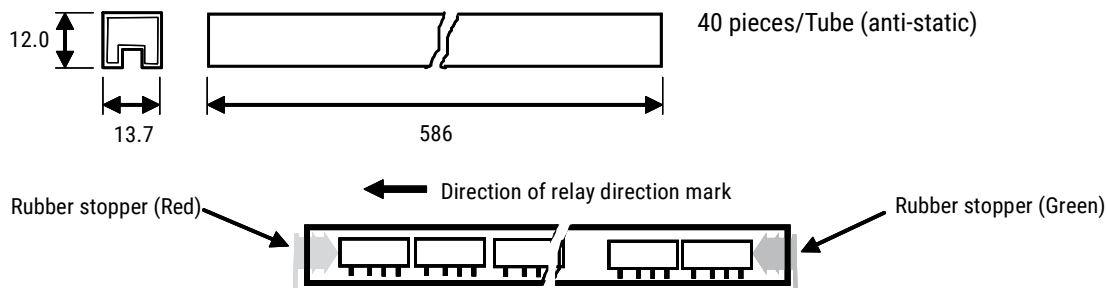

## Tape & Reel Packaging Information (EB2 only) – Millimeters

### Appearance

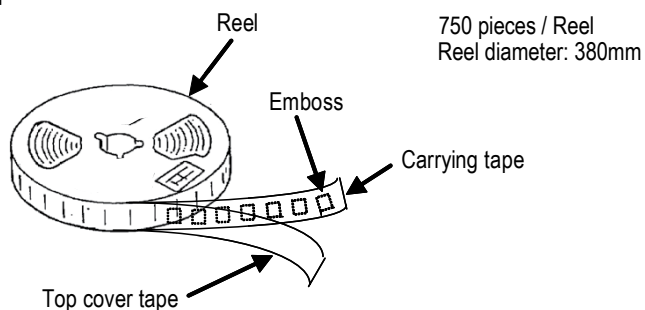

### Tape Dimensions

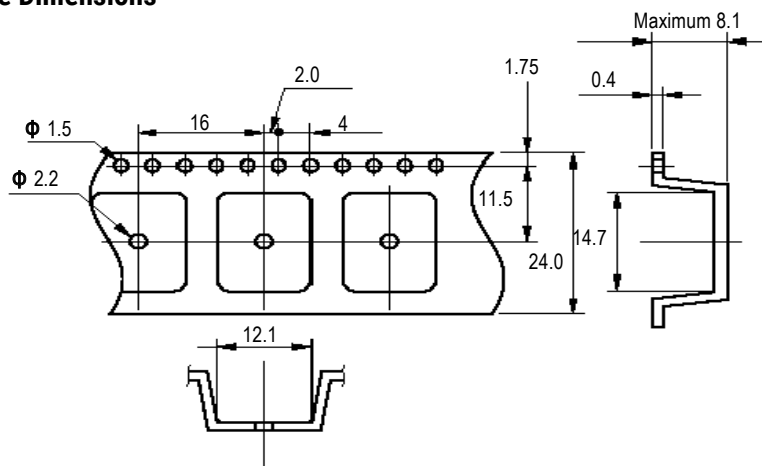

### Relay Direction Mark and Tape Carrying Direction

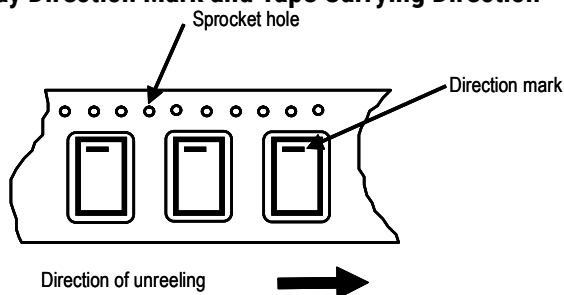

## Notes on Using Relays

### 1. Contact Load

Make sure that the contact load is within the specified range; otherwise, the lifetime of the contacts will be shortened considerably. Note that the running performance shown is an example, and that it varies depending on parameters such as the type of load, switching frequency, driver circuit, and ambient temperature under the actual operating conditions.

### 2. Driving Relays

- If the internal connection diagram of a relay shows + and – symbols on the coil, apply the rated voltage to the relay in the specified direction. If a rippled DC current source is used, abnormalities such as heat at the coil may occur.
- The maximum voltage that can be applied to the coil of the relay varies depending on the ambient temperature. Generally, the higher the voltage applied to the coil, the shorter the operating time. Note, however, that high voltage also increases the bounce of the contacts and the contact opening and closing frequency, which may shorten the lifetime of the contacts.

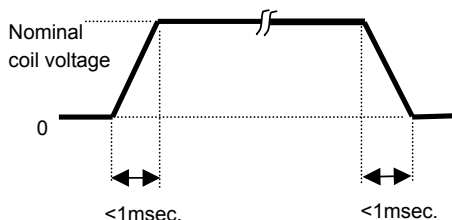

- For consistent operation, the driving voltage should have rise and fall times of less than 1 ms.
- For a latching relay, apply a voltage to the coil according to the polarity specified in the internal connection diagram of the relay.
- If a current is applied to the coil over a long period of time, the coil temperature rises, promoting generation of organic gas inside the relay, which may result in faulty contacts. In this case, use of a latching relay is recommended.
- The operating time and release time indicate the time required for each contact to close after the voltage has been applied to or removed from the coil. However, because the relay has a mechanical structure, a bounce state exists at the end of the operating and release times. Furthermore, because additional time is required until the contact stabilizes after being in a high-resistance state, care must be taken when using the relay at high speeds.

### 3. Operating Environment

- Make sure that the relay mounted in the application set is used within the specified temperature range. Use of a relay at a temperature outside this range may adversely affect insulation or contact performance.
- If the relay is used for a long period of time in highly humid (RH 85% or higher) environment, moisture may be absorbed into the relay. This moisture may react with the NO<sub>x</sub> and SO<sub>x</sub> generated by glow discharges that occur when the contacts are opened or closed, producing nitric or sulfuric acid. If this happens, the acid produced may corrode the metallic parts of the relay, causing operational malfunction.
- If any material containing silicon (silicon rubber, silicon oil, and silicon based coating material) is used in the neighborhood of relay, there is some possibility that these materials will emit silicon gas that will penetrate the relay. In this case, the switching contact may generate silicon compounds on the surface of contacts. This silicon compound may result in contact failure. Avoid use of relay in such an environment.

## Notes on Using Relays cont.

- Because the operating temperature range varies depending on the humidity, use the relay in the temperature range illustrated in the figure below. Prevent the relay from being frozen and avoid the generation of condensation.

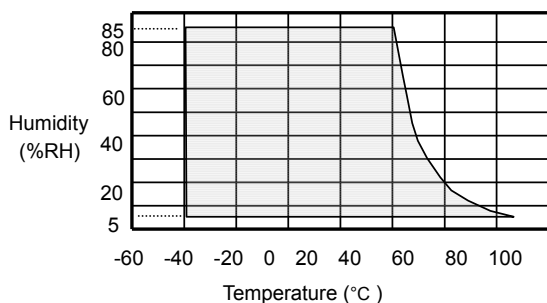

- The relay maintains constant sealability under normal atmospheric pressure (810 to 1,200 hpa). Its sealability may be degraded or the relay may be deformed and malfunction if it is used under barometric conditions exceeding the specified range.
- The same applies when the relay is stored or transported. Keep the upper-limit value of the temperature to which the relay is exposed after it is removed from the carton box to within 50°C.
- Permanent magnets are used in polarized relays. For this reason, when magnets, transformers, or speakers are located nearby the relay characteristics may change and faulty operations may result.
- If excessive vibration or shock is applied to the relay, it may malfunction and the contacts remain closed. Vibration or shock applied to the relay during operation may cause considerable damage to or wearing of the contacts. Note that operation of a snap switch mounted close to the relay or shock due to the operation of magnetic solenoid may also cause malfunctioning.

## 4. Mounting

- When mounting a relay onto a PC board using an automatic chip mouter, if excessive force is applied to the cover of the relay when the relay is chucked or inserted, the cover may be damaged or the characteristics of the relay degraded. Keep the force applied to the relay to within 1 kg.
- Avoid bending the pins to temporarily secure the relay to the PC board. Bending the pins may degrade sealability or adversely affect the internal mechanism.
- Ventilation immediately after soldering is recommended. Avoid immersing the relay in cleaning solvent immediately after soldering due to the danger of thermal shock being applied to the relay.
- Use an alcohol-based or water-based cleaning solvent. Never use thinner and benzene because they may damage the relay housing.
- Do not use ultrasonic cleaning because the vibration energy generated by the ultrasonic waves may cause the contacts to remain closed.

## Notes on Using Relays cont.

### 5. Handling and Storage

- Relays are packaged in magazine cases for shipment. If a space is created in the case after some relays have been removed, be sure to insert a stopper to secure the remaining relays in the case. If relays are not well secured, vibration during transportation may cause malfunctioning of the contacts.
- Exercise care in handling the relay so as to avoid dropping it or allowing it to fall. Do not use a relay that has been dropped. If a relay drops from a workbench to the floor, a shock of 9,800 m/s<sup>2</sup> (1,000 G) or more is applied to the relay, possibly damaging its functions. Even if a light shock has been applied to the relay, thoroughly evaluate its operation before using it.
- Latching relays are factory-set to reset state for shipment. A latching relay may be set, however, by vibration or shock applied while being transported. Be sure to forcibly reset the relay before using it in the application set. Also note that the relay may be set by unexpected vibration or shock when it is used in a portable set.
- The sealability of a surface mount (SMT) relay may be lost if the relay absorbs and is then heated during soldering.

When storing relays, therefore, observe the following points:

1. For standard packing, please use relays within 12 months after delivery (storage conditions: 30°C/60% RH). If the relays have moisture absorption, dehumidify as follows:
  - Tape Packaging: 50 ±5°C, 200–300 hours.
  - Simple Relay: 85 ±5°C, 48 hours.
2. For MBB packing, please use relays within 2 years after delivery (storage conditions: 30°C/60% RH). After opening MBB packing, please use within 3 months (storage conditions: 30°C/60% RH).

## KEMET Electronics Corporation Sales Offices

For a complete list of our global sales offices, please visit [www.kemet.com/sales](http://www.kemet.com/sales).

---

### Disclaimer

All product specifications, statements, information and data (collectively, the "Information") in this datasheet are subject to change. The customer is responsible for checking and verifying the extent to which the Information contained in this publication is applicable to an order at the time the order is placed. All Information given herein is believed to be accurate and reliable, but it is presented without guarantee, warranty, or responsibility of any kind, expressed or implied.

Statements of suitability for certain applications are based on KEMET Electronics Corporation's ("KEMET") knowledge of typical operating conditions for such applications, but are not intended to constitute – and KEMET specifically disclaims – any warranty concerning suitability for a specific customer application or use. The Information is intended for use only by customers who have the requisite experience and capability to determine the correct products for their application. Any technical advice inferred from this Information or otherwise provided by KEMET with reference to the use of KEMET's products is given gratis, and KEMET assumes no obligation or liability for the advice given or results obtained.

Although KEMET designs and manufactures its products to the most stringent quality and safety standards, given the current state of the art, isolated component failures may still occur. Accordingly, customer applications which require a high degree of reliability or safety should employ suitable designs or other safeguards (such as installation of protective circuitry or redundancies) in order to ensure that the failure of an electrical component does not result in a risk of personal injury or property damage.

Although all product-related warnings, cautions and notes must be observed, the customer should not assume that all safety measures are indicated or that other measures may not be required.

When providing KEMET products and technologies contained herein to other countries, the customer must abide by the procedures and provisions stipulated in all applicable export laws and regulations, including without limitation the International Traffic in Arms Regulations (ITAR), the US Export Administration Regulations (EAR) and the Japan Foreign Exchange and Foreign Trade Act.

*KEMET is a registered trademark of KEMET Electronics Corporation.*



## X-ON Electronics

Largest Supplier of Electrical and Electronic Components

*Click to view similar products for [Low Signal Relays - PCB category](#):*

*Click to view products by [Kemet manufacturer](#):*

Other Similar products are found below :

[LZN4-US-DC12](#) [LZNQ4-US-DC24](#) [LZNQ4-US-DC48](#) [6-1393813-4](#) [6-1462039-0](#) [6-1617347-5](#) [6-1617353-3](#) [6-1617529-6](#) [M39016/20-054M](#) [M39016/27-030M](#) [67RPCX-3](#) [MAHC-5494](#) [D3493L](#) [7-1393809-0](#) [7-1393813-3](#) [741B8](#) [7556072001](#) [MF-11AM-24](#) [MF1201N12](#) [MF-17A-24](#) [FBR244D024/02CS](#) [80.010.4522.1](#) [FL-4036](#) [FLH-11D-6](#) [831A7](#) [MMS124](#) [FTR-B4GA006Z](#) [FW1102S06](#) [FW1201S39](#) [FW1210S02](#) [FW1521S01](#) [FW5A1201S14](#) [9-1393813-6](#) [9-1617582-5](#) [G6AK-2-H-DC5](#) [G6E-184P-ST-US-DC48](#) [G6G234CDC24](#) [A07A939BZ1-0388](#) [A150-0005](#) [PZ-2A2420](#) [HB1-DC6V](#) [HB1-DC9V](#) [R10-14A10-240](#) [R10-14D10-12](#) [R10-5A10-120F](#) [R10-E1L8-S200](#) [R10-E2468-1](#) [R10-E4Z2-V700](#) [R10-T1L2N-115V](#) [R40-E1Z4-V50](#)