

# F161 Encapsulated Stacked, Size 2220 – 6560, 50 – 630 VDC (Automotive Grade)

## Overview

KEMET's F161 polyester (PET) film surface mount capacitor is encapsulated in a self-extinguishing material, meeting the requirements of UL 94 V-0. This series meets IEC 60384-19 standards, as well as the demanding Automotive Electronics Council's AEC-Q200 qualification.

## Applications

Typical applications include bypassing and signal coupling. F161 is a general purpose series designed for the highest reliability.

## Benefits

- Rated voltage: 50 – 630 VDC
- Rated voltage: 30 – 250 VAC
- Capacitance range: 0.01 – 12  $\mu$ F
- EIA size: 2220 – 6560
- Capacitance tolerance:  $\pm$ 5%,  $\pm$ 10%,  $\pm$ 20%, other tolerances available on request
- Climatic category: 55/125/56
- RoHS Compliant and lead-free terminations
- Operating temperature range of  $-55^{\circ}\text{C}$  to  $+125^{\circ}\text{C}$
- Automotive grade options available

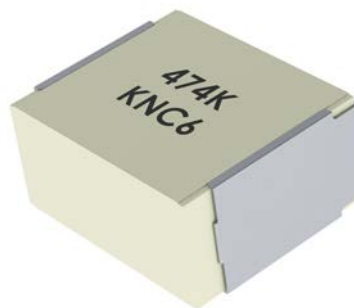

## Part Number System

| F               | 161                                     | P  | P                   | 103   | K   | 050  | V                          |
|-----------------|---|--|---------------------|---|---|--|----------------------------|
| Capacitor Class | Series                                  | Chip Size  | Size Code           | Capacitance Code (pF)   | Capacitance Tolerance   | Rated Voltage (VDC)  | Packaging Code             |
| F = Film        | Metallized Polyester Stacked Technology | P = 2220<br>S = 2824<br>W = 4036<br>Y = 5045<br>Z = 6560 | See Dimension Table | First two digits indicate the two most significant digits of the capacitance value in picofarads. The third digit is the number of following zeros. | J = $\pm$ 5<br>K = $\pm$ 10%<br>M = $\pm$ 20%<br>Other tolerances on request. | 050 = 50<br>063 = 63<br>100 = 100<br>250 = 250<br>400 = 400<br>630 = 630 | See Ordering Options Table |

## Ordering Options Table

| Chip Size (EIA) | Packaging Type                                   | Packaging Code |
|-----------------|--|----------------|
| 2220            | <b>Standard Packaging Options</b>                |                |
|                 | Tape & Reel (Standard Reel)                      | V              |
|                 | Bulk (Bag)                                       | A              |
| 2824            | <b>Standard Packaging Options</b>                |                |
|                 | Tape & Reel (Standard Reel)                      | V              |
|                 | Bulk (Bag)                                       | A              |
| 4036            | <b>Standard Packaging Options</b>                |                |
|                 | Tape & Reel (Standard Reel)                      | V              |
|                 | Bulk (Bag)                                       | A              |
|                 | <b>Other Packaging Options</b>                   |                |
|                 | Tape & Reel (Vertical Orientation Standard Reel) | Y              |
| 5045            | <b>Standard Packaging Options</b>                |                |
|                 | Tape & Reel (Standard Reel)                      | V              |
|                 | Bulk (Bag)                                       | A              |
|                 | <b>Other Packaging Options</b>                   |                |
|                 | Tape & Reel (Vertical Orientation Standard Reel) | Y              |
| 6560            | <b>Standard Packaging Options</b>                |                |
|                 | Tape & Reel (Standard Reel)                      | V              |
|                 | Bulk (Bag)                                       | A              |
|                 | <b>Other Packaging Options</b>                   |                |
|                 | Tape & Reel (Vertical Orientation Standard Reel) | Y              |

## Dimensions – Millimeters

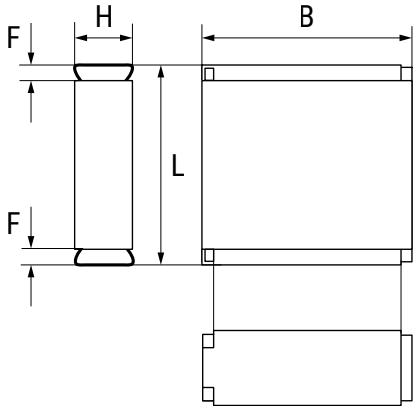

| Size Code | Chip Size (EIA) | B       |           | H       |           | L       |           | F       |           |
|-----------|-----------------|---------|-----------|---------|-----------|---------|-----------|---------|-----------|
|           |                 | Nominal | Tolerance | Nominal | Tolerance | Nominal | Tolerance | Nominal | Tolerance |
| PP        | 2220            | 5.0     | ±0.2      | 3.0     | ±0.2      | 5.7     | ±0.2      | 0.5     | Nominal   |
| PU        | 2220            | 5.0     | ±0.2      | 4.0     | ±0.2      | 5.7     | ±0.2      | 0.5     | Nominal   |
| SL        | 2824            | 6.0     | ±0.2      | 3.0     | ±0.2      | 7.3     | ±0.2      | 0.5     | Nominal   |
| SP        | 2824            | 6.0     | ±0.2      | 3.5     | ±0.2      | 7.3     | ±0.2      | 0.5     | Nominal   |
| ST        | 2824            | 6.0     | ±0.2      | 4.5     | ±0.2      | 7.3     | ±0.2      | 0.5     | Nominal   |
| WP        | 4036            | 9.1     | ±0.2      | 5.5     | ±0.2      | 10.2    | ±0.2      | 0.5     | Nominal   |
| YR        | 5045            | 11.5    | ±0.2      | 6.5     | ±0.2      | 12.7    | ±0.2      | 0.5     | Nominal   |
| ZS        | 6560            | 15.0    | ±0.2      | 7.0     | ±0.2      | 16.5    | ±0.2      | 0.5     | Nominal   |

## Environmental Compliance

All KEMET surface mount capacitors are RoHS Compliant.



## Qualification

Automotive Grade products meet or exceed the requirements outlined by the Automotive Electronics Council. Details regarding test methods and conditions are referenced in document AEC-Q200, Stress Test Qualification for Passive Components. For additional information regarding the Automotive Electronics Council and AEC-Q200, please visit their website at [www.aecouncil.com](http://www.aecouncil.com).

## Performance Characteristics

|                                |   |             |                |               |              |            |         |
|--------------------------------|---|-------------|----------------|---------------|--------------|------------|---------|
| Rated Voltage (VDC)            | 50  | 63          | 100            | 250           | 400          | 630        |         |
| Rated Voltage (VAC)            | 30  | 40          | 63             | 160           | 200          | 250        |         |
| Capacitance Range (µF)         | 0.01 – 12.0   | 0.01 – 4.7  | 0.01 – 4.7     | 0.01 – 1.0    | 0.022 – 0.47 | 0.1 – 0.18 |         |
| Chip Size (EIA)                | 2220 – 6560   |             |                |               |              |            |         |
| Capacitance Tolerance          | ±5%, ±10%, ±20%, other tolerances available on request  |             |                |               |              |            |         |
| Category Temperature Range     | -55°C to +125°C   |             |                |               |              |            |         |
| Rated Temperature              | +85°C   |             |                |               |              |            |         |
| Voltage Derating               | The rated voltage is decreased with 1.25%/°C from +85°C   |             |                |               |              |            |         |
| Climatic Category              | 55/125/56   |             |                |               |              |            |         |
| Test Voltage                   | 1.6 x V <sub>R</sub> , 60 seconds   |             |                |               |              |            |         |
| Insulation Resistance          | Measured at +20°C, Charging Time 1 Minute   |             |                |               |              |            |         |
|                                | Minimum Values Between Terminals  |             |                |               |              |            |         |
|                                | Charging Voltage  | C ≤ 0.33 µF |                | C > 0.33 µF   |              |            |         |
|                                | 10 V for V <sub>R</sub> ≤ 100   | 1,000 MΩ    |                | 400 MΩ · µF   |              |            |         |
| 100 v for V <sub>R</sub> > 100 | 1,000 MΩ  |             | 400 MΩ · µF    |               |              |            |         |
| Dissipation Factor             | Maximum Values at +23°C   |             |                |               |              |            |         |
|                                |   | C ≤ 0.1 µF  | 0.1 < C < 1 µF | 1 ≤ C ≤ 10 µF | C > 10 µF    |            |         |
|                                | 1 kHz   | 0.8%        | 0.8%           | 0.8%          | 0.8%         |            |         |
|                                | 10 kHz  | 1.2%        | 1.2%           | 1.5%          | 3.0%         |            |         |
| 100 kHz                        | 2.5%  | 3.0%        |                |               |              |            |         |
| Maximum Pulse Rise Time        | The capacitors can withstand an unlimited number of pulses with a dV/dt according to Table below. |             |                |               |              |            |         |
|                                | Voltage Range   | 50 VDC      | 63 VDC         | 100 VDC       | 250 VDC      | 400 VDC    | 630 VDC |
|                                | dV/dt (V/µs)  | 40          | 40             | 50            | 150          | 200        | 250     |

### Capacitance vs. Temperature

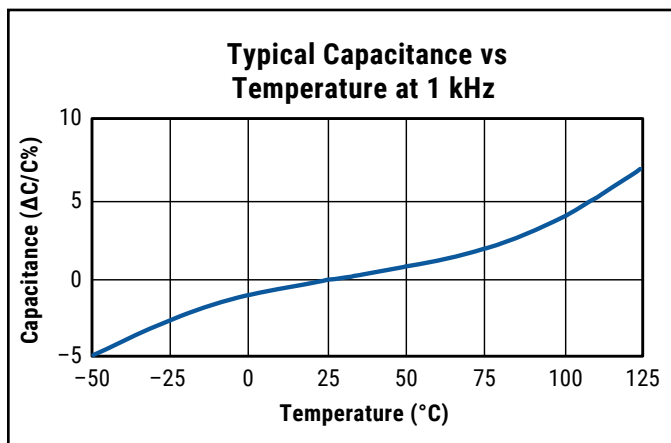

### Dissipation Factor vs. Temperature

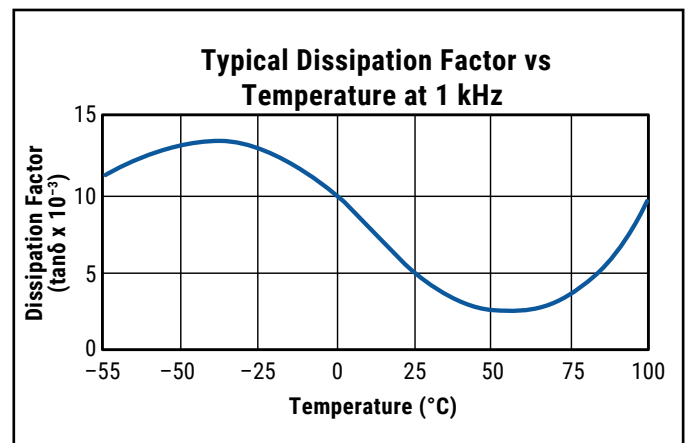

**Table 1 – Ratings & Part Number Reference**

| VDC | VAC | Capacitance Value (µF) | Chip Size | Dimension in mm |        |        | dV/dt (V/µs) | Part Number        |
|-----|-----|------------------------|-----------|-----------------|--------|--------|--------------|--------------------|
|     |     |                        |           | B               | H      | L      |              |                    |
| 50  | 30  | 0.01                   | 2220      | 5.0             | 3.0    | 5.7    | 40           | F161PP103(1)050(2) |
| 50  | 30  | 0.012                  | 2220      | 5.0             | 3.0    | 5.7    | 40           | F161PP123(1)050(2) |
| 50  | 30  | 0.015                  | 2220      | 5.0             | 3.0    | 5.7    | 40           | F161PP153(1)050(2) |
| 50  | 30  | 0.018                  | 2220      | 5.0             | 3.0    | 5.7    | 40           | F161PP183(1)050(2) |
| 50  | 30  | 0.022                  | 2220      | 5.0             | 3.0    | 5.7    | 40           | F161PP223(1)050(2) |
| 50  | 30  | 0.027                  | 2220      | 5.0             | 3.0    | 5.7    | 40           | F161PP273(1)050(2) |
| 50  | 30  | 0.033                  | 2220      | 5.0             | 3.0    | 5.7    | 40           | F161PP333(1)050(2) |
| 50  | 30  | 0.039                  | 2220      | 5.0             | 3.0    | 5.7    | 40           | F161PP393(1)050(2) |
| 50  | 30  | 0.047                  | 2220      | 5.0             | 3.0    | 5.7    | 40           | F161PP473(1)050(2) |
| 50  | 30  | 0.056                  | 2220      | 5.0             | 3.0    | 5.7    | 40           | F161PP563(1)050(2) |
| 50  | 30  | 0.068                  | 2220      | 5.0             | 3.0    | 5.7    | 40           | F161PP683(1)050(2) |
| 50  | 30  | 0.082                  | 2220      | 5.0             | 3.0    | 5.7    | 40           | F161PP823(1)050(2) |
| 50  | 30  | 0.1                    | 2220      | 5.0             | 3.0    | 5.7    | 40           | F161PP104(1)050(2) |
| 50  | 30  | 0.12                   | 2220      | 5.0             | 3.0    | 5.7    | 40           | F161PP124(1)050(2) |
| 50  | 30  | 0.15                   | 2220      | 5.0             | 3.0    | 5.7    | 40           | F161PP154(1)050(2) |
| 50  | 30  | 0.18                   | 2220      | 5.0             | 4.0    | 5.7    | 40           | F161PU184(1)050(2) |
| 50  | 30  | 0.22                   | 2220      | 5.0             | 4.0    | 5.7    | 40           | F161PU224(1)050(2) |
| 50  | 30  | 0.01                   | 2824      | 6.0             | 3.0    | 7.3    | 40           | F161SL103(1)050(2) |
| 50  | 30  | 0.012                  | 2824      | 6.0             | 3.0    | 7.3    | 40           | F161SL123(1)050(2) |
| 50  | 30  | 0.015                  | 2824      | 6.0             | 3.0    | 7.3    | 40           | F161SL153(1)050(2) |
| 50  | 30  | 0.018                  | 2824      | 6.0             | 3.0    | 7.3    | 40           | F161SL183(1)050(2) |
| 50  | 30  | 0.022                  | 2824      | 6.0             | 3.0    | 7.3    | 40           | F161SL223(1)050(2) |
| 50  | 30  | 0.027                  | 2824      | 6.0             | 3.0    | 7.3    | 40           | F161SL273(1)050(2) |
| 50  | 30  | 0.033                  | 2824      | 6.0             | 3.0    | 7.3    | 40           | F161SL333(1)050(2) |
| 50  | 30  | 0.039                  | 2824      | 6.0             | 3.0    | 7.3    | 40           | F161SL393(1)050(2) |
| 50  | 30  | 0.047                  | 2824      | 6.0             | 3.0    | 7.3    | 40           | F161SL473(1)050(2) |
| 50  | 30  | 0.056                  | 2824      | 6.0             | 3.0    | 7.3    | 40           | F161SL563(1)050(2) |
| 50  | 30  | 0.068                  | 2824      | 6.0             | 3.0    | 7.3    | 40           | F161SL683(1)050(2) |
| 50  | 30  | 0.082                  | 2824      | 6.0             | 3.0    | 7.3    | 40           | F161SL823(1)050(2) |
| 50  | 30  | 0.1                    | 2824      | 6.0             | 3.0    | 7.3    | 40           | F161SL104(1)050(2) |
| 50  | 30  | 0.12                   | 2824      | 6.0             | 3.0    | 7.3    | 40           | F161SL124(1)050(2) |
| 50  | 30  | 0.15                   | 2824      | 6.0             | 3.0    | 7.3    | 40           | F161SL154(1)050(2) |
| 50  | 30  | 0.18                   | 2824      | 6.0             | 3.0    | 7.3    | 40           | F161SL184(1)050(2) |
| 50  | 30  | 0.22                   | 2824      | 6.0             | 3.0    | 7.3    | 40           | F161SL224(1)050(2) |
| 50  | 30  | 0.27                   | 2824      | 6.0             | 3.5    | 7.3    | 40           | F161SP274(1)050(2) |
| 50  | 30  | 0.33                   | 2824      | 6.0             | 3.5    | 7.3    | 40           | F161SP334(1)050(2) |
| 50  | 30  | 0.39                   | 2824      | 6.0             | 3.5    | 7.3    | 40           | F161SP394(1)050(2) |
| 50  | 30  | 0.47                   | 2824      | 6.0             | 3.5    | 7.3    | 40           | F161SP474(1)050(2) |
| 50  | 30  | 0.56                   | 2824      | 6.0             | 4.5    | 7.3    | 40           | F161ST564(1)050(2) |
| 50  | 30  | 0.68                   | 2824      | 6.0             | 4.5    | 7.3    | 40           | F161ST684(1)050(2) |
| 50  | 30  | 0.82                   | 2824      | 6.0             | 4.5    | 7.3    | 40           | F161ST824(1)050(2) |
| 50  | 30  | 1                      | 2824      | 6.0             | 4.5    | 7.3    | 40           | F161ST105(1)050(2) |
| 50  | 30  | 0.022                  | 4036      | 9.1             | 5.5    | 10.2   | 40           | F161WP223(1)050(2) |
| 50  | 30  | 0.027                  | 4036      | 9.1             | 5.5    | 10.2   | 40           | F161WP273(1)050(2) |
| 50  | 30  | 0.033                  | 4036      | 9.1             | 5.5    | 10.2   | 40           | F161WP333(1)050(2) |
| 50  | 30  | 0.039                  | 4036      | 9.1             | 5.5    | 10.2   | 40           | F161WP393(1)050(2) |
| 50  | 30  | 0.047                  | 4036      | 9.1             | 5.5    | 10.2   | 40           | F161WP473(1)050(2) |
| 50  | 30  | 0.056                  | 4036      | 9.1             | 5.5    | 10.2   | 40           | F161WP563(1)050(2) |
| 50  | 30  | 0.068                  | 4036      | 9.1             | 5.5    | 10.2   | 40           | F161WP683(1)050(2) |
| 50  | 30  | 0.082                  | 4036      | 9.1             | 5.5    | 10.2   | 40           | F161WP823(1)050(2) |
| 50  | 30  | 0.1                    | 4036      | 9.1             | 5.5    | 10.2   | 40           | F161WP104(1)050(2) |
| 50  | 30  | 0.12                   | 4036      | 9.1             | 5.5    | 10.2   | 40           | F161WP124(1)050(2) |
| 50  | 30  | 0.15                   | 4036      | 9.1             | 5.5    | 10.2   | 40           | F161WP154(1)050(2) |
| 50  | 30  | 0.18                   | 4036      | 9.1             | 5.5    | 10.2   | 40           | F161WP184(1)050(2) |
| 50  | 30  | 0.22                   | 4036      | 9.1             | 5.5    | 10.2   | 40           | F161WP224(1)050(2) |
| 50  | 30  | 0.27                   | 4036      | 9.1             | 5.5    | 10.2   | 40           | F161WP274(1)050(2) |
| 50  | 30  | 0.33                   | 4036      | 9.1             | 5.5    | 10.2   | 40           | F161WP334(1)050(2) |
| 50  | 30  | 0.39                   | 4036      | 9.1             | 5.5    | 10.2   | 40           | F161WP394(1)050(2) |
| 50  | 30  | 0.47                   | 4036      | 9.1             | 5.5    | 10.2   | 40           | F161WP474(1)050(2) |
| 50  | 30  | 0.56                   | 4036      | 9.1             | 5.5    | 10.2   | 40           | F161WP564(1)050(2) |
| VDC | VAC | Capacitance Value (µF) | Chip Size | B (mm)          | H (mm) | L (mm) | dV/dt (Vµs)  | Part Number        |

(1) J = ±5%, K = ±10%, M = ±20%, other tolerances on request.

(2) Insert ordering code for lead type and packaging. See Ordering Options Table for available options.

**Table 1 – Ratings & Part Number Reference cont.**

| VDC | VAC | Capacitance Value (µF) | Chip Size | Dimension in mm |        |        | dV/dt (V/µs) | Part Number        |
|-----|-----|------------------------|-----------|-----------------|--------|--------|--------------|--------------------|
|     |     |                        |           | B               | H      | L      |              |                    |
| 50  | 30  | 0.68                   | 4036      | 9.1             | 5.5    | 10.2   | 40           | F161WP684(1)050(2) |
| 50  | 30  | 0.82                   | 4036      | 9.1             | 5.5    | 10.2   | 40           | F161WP824(1)050(2) |
| 50  | 30  | 1                      | 4036      | 9.1             | 5.5    | 10.2   | 40           | F161WP105(1)050(2) |
| 50  | 30  | 1.2                    | 4036      | 9.1             | 5.5    | 10.2   | 40           | F161WP125(1)050(2) |
| 50  | 30  | 1.5                    | 4036      | 9.1             | 5.5    | 10.2   | 40           | F161WP155(1)050(2) |
| 50  | 30  | 1.8                    | 4036      | 9.1             | 5.5    | 10.2   | 40           | F161WP185(1)050(2) |
| 50  | 30  | 2.2                    | 4036      | 9.1             | 5.5    | 10.2   | 40           | F161WP225(1)050(2) |
| 50  | 30  | 2.7                    | 5045      | 11.5            | 6.5    | 12.7   | 40           | F161YR275(1)050(2) |
| 50  | 30  | 3.3                    | 5045      | 11.5            | 6.5    | 12.7   | 40           | F161YR335(1)050(2) |
| 50  | 30  | 3.9                    | 5045      | 11.5            | 6.5    | 12.7   | 40           | F161YR395(1)050(2) |
| 50  | 30  | 4.7                    | 5045      | 11.5            | 6.5    | 12.7   | 40           | F161YR475(1)050(2) |
| 50  | 30  | 5.6                    | 6560      | 15.0            | 7.0    | 16.5   | 40           | F161ZS565(1)050(2) |
| 50  | 30  | 6.8                    | 6560      | 15.0            | 7.0    | 16.5   | 40           | F161ZS685(1)050(2) |
| 50  | 30  | 8.2                    | 6560      | 15.0            | 7.0    | 16.5   | 40           | F161ZS825(1)050(2) |
| 50  | 30  | 10                     | 6560      | 15.0            | 7.0    | 16.5   | 40           | F161ZS106(1)050(2) |
| 50  | 30  | 12                     | 6560      | 15.0            | 7.0    | 16.5   | 40           | F161ZS126(1)050(2) |
| 63  | 40  | 0.01                   | 2824      | 6.0             | 3.0    | 7.3    | 40           | F161SL103(1)063(2) |
| 63  | 40  | 0.012                  | 2824      | 6.0             | 3.0    | 7.3    | 40           | F161SL123(1)063(2) |
| 63  | 40  | 0.015                  | 2824      | 6.0             | 3.0    | 7.3    | 40           | F161SL153(1)063(2) |
| 63  | 40  | 0.018                  | 2824      | 6.0             | 3.0    | 7.3    | 40           | F161SL183(1)063(2) |
| 63  | 40  | 0.022                  | 2824      | 6.0             | 3.0    | 7.3    | 40           | F161SL223(1)063(2) |
| 63  | 40  | 0.027                  | 2824      | 6.0             | 3.0    | 7.3    | 40           | F161SL273(1)063(2) |
| 63  | 40  | 0.033                  | 2824      | 6.0             | 3.0    | 7.3    | 40           | F161SL333(1)063(2) |
| 63  | 40  | 0.039                  | 2824      | 6.0             | 3.0    | 7.3    | 40           | F161SL393(1)063(2) |
| 63  | 40  | 0.047                  | 2824      | 6.0             | 3.0    | 7.3    | 40           | F161SL473(1)063(2) |
| 63  | 40  | 0.056                  | 2824      | 6.0             | 3.0    | 7.3    | 40           | F161SL563(1)063(2) |
| 63  | 40  | 0.068                  | 2824      | 6.0             | 3.0    | 7.3    | 40           | F161SL683(1)063(2) |
| 63  | 40  | 0.082                  | 2824      | 6.0             | 3.0    | 7.3    | 40           | F161SL823(1)063(2) |
| 63  | 40  | 0.1                    | 2824      | 6.0             | 3.0    | 7.3    | 40           | F161SL104(1)063(2) |
| 63  | 40  | 0.12                   | 2824      | 6.0             | 3.0    | 7.3    | 40           | F161SL124(1)063(2) |
| 63  | 40  | 0.15                   | 2824      | 6.0             | 3.0    | 7.3    | 40           | F161SL154(1)063(2) |
| 63  | 40  | 0.18                   | 2824      | 6.0             | 3.0    | 7.3    | 40           | F161SL184(1)063(2) |
| 63  | 40  | 0.22                   | 2824      | 6.0             | 3.0    | 7.3    | 40           | F161SL224(1)063(2) |
| 63  | 40  | 0.27                   | 2824      | 6.0             | 3.5    | 7.3    | 40           | F161SP274(1)063(2) |
| 63  | 40  | 0.33                   | 2824      | 6.0             | 3.5    | 7.3    | 40           | F161SP334(1)063(2) |
| 63  | 40  | 0.39                   | 2824      | 6.0             | 3.5    | 7.3    | 40           | F161SP394(1)063(2) |
| 63  | 40  | 0.47                   | 2824      | 6.0             | 3.5    | 7.3    | 40           | F161SP474(1)063(2) |
| 63  | 40  | 0.022                  | 4036      | 9.1             | 5.5    | 10.2   | 40           | F161WP223(1)063(2) |
| 63  | 40  | 0.027                  | 4036      | 9.1             | 5.5    | 10.2   | 40           | F161WP273(1)063(2) |
| 63  | 40  | 0.033                  | 4036      | 9.1             | 5.5    | 10.2   | 40           | F161WP333(1)063(2) |
| 63  | 40  | 0.039                  | 4036      | 9.1             | 5.5    | 10.2   | 40           | F161WP393(1)063(2) |
| 63  | 40  | 0.047                  | 4036      | 9.1             | 5.5    | 10.2   | 40           | F161WP473(1)063(2) |
| 63  | 40  | 0.056                  | 4036      | 9.1             | 5.5    | 10.2   | 40           | F161WP563(1)063(2) |
| 63  | 40  | 0.068                  | 4036      | 9.1             | 5.5    | 10.2   | 40           | F161WP683(1)063(2) |
| 63  | 40  | 0.082                  | 4036      | 9.1             | 5.5    | 10.2   | 40           | F161WP823(1)063(2) |
| 63  | 40  | 0.1                    | 4036      | 9.1             | 5.5    | 10.2   | 40           | F161WP104(1)063(2) |
| 63  | 40  | 0.12                   | 4036      | 9.1             | 5.5    | 10.2   | 40           | F161WP124(1)063(2) |
| 63  | 40  | 0.15                   | 4036      | 9.1             | 5.5    | 10.2   | 40           | F161WP154(1)063(2) |
| 63  | 40  | 0.18                   | 4036      | 9.1             | 5.5    | 10.2   | 40           | F161WP184(1)063(2) |
| 63  | 40  | 0.22                   | 4036      | 9.1             | 5.5    | 10.2   | 40           | F161WP224(1)063(2) |
| 63  | 40  | 0.27                   | 4036      | 9.1             | 5.5    | 10.2   | 40           | F161WP274(1)063(2) |
| 63  | 40  | 0.33                   | 4036      | 9.1             | 5.5    | 10.2   | 40           | F161WP334(1)063(2) |
| 63  | 40  | 0.39                   | 4036      | 9.1             | 5.5    | 10.2   | 40           | F161WP394(1)063(2) |
| 63  | 40  | 0.47                   | 4036      | 9.1             | 5.5    | 10.2   | 40           | F161WP474(1)063(2) |
| 63  | 40  | 0.56                   | 4036      | 9.1             | 5.5    | 10.2   | 40           | F161WP564(1)063(2) |
| 63  | 40  | 0.68                   | 4036      | 9.1             | 5.5    | 10.2   | 40           | F161WP684(1)063(2) |
| 63  | 40  | 0.82                   | 4036      | 9.1             | 5.5    | 10.2   | 40           | F161WP824(1)063(2) |
| 63  | 40  | 1                      | 4036      | 9.1             | 5.5    | 10.2   | 40           | F161WP105(1)063(2) |
| 63  | 40  | 1.2                    | 4036      | 9.1             | 5.5    | 10.2   | 40           | F161WP125(1)063(2) |
| VDC | VAC | Capacitance Value (µF) | Chip Size | B (mm)          | H (mm) | L (mm) | dV/dt (Vµs)  | Part Number        |

(1) J = ±5%, K = ±10%, M = ±20%, other tolerances on request.

(2) Insert ordering code for lead type and packaging. See Ordering Options Table for available options.

**Table 1 – Ratings & Part Number Reference cont.**

| VDC | VAC | Capacitance Value (µF) | Chip Size | Dimension in mm |        |        | dV/dt (V/µs) | Part Number        |
|-----|-----|------------------------|-----------|-----------------|--------|--------|--------------|--------------------|
|     |     |                        |           | B               | H      | L      |              |                    |
| 63  | 40  | 1.5                    | 4036      | 9.1             | 5.5    | 10.2   | 40           | F161WP155(1)063(2) |
| 63  | 40  | 1.8                    | 5045      | 11.5            | 6.5    | 12.7   | 40           | F161YR185(1)063(2) |
| 63  | 40  | 2.2                    | 5045      | 11.5            | 6.5    | 12.7   | 40           | F161YR225(1)063(2) |
| 63  | 40  | 2.7                    | 5045      | 11.5            | 6.5    | 12.7   | 40           | F161YR275(1)063(2) |
| 63  | 40  | 3.3                    | 5045      | 11.5            | 6.5    | 12.7   | 40           | F161YR335(1)063(2) |
| 63  | 40  | 3.9                    | 6560      | 15.0            | 7.0    | 16.5   | 40           | F161ZS395(1)063(2) |
| 63  | 40  | 4.7                    | 6560      | 15.0            | 7.0    | 16.5   | 40           | F161ZS475(1)063(2) |
| 100 | 63  | 0.01                   | 2220      | 5.0             | 3.0    | 5.7    | 50           | F161PP103(1)100(2) |
| 100 | 63  | 0.012                  | 2220      | 5.0             | 3.0    | 5.7    | 50           | F161PP123(1)100(2) |
| 100 | 63  | 0.015                  | 2220      | 5.0             | 3.0    | 5.7    | 50           | F161PP153(1)100(2) |
| 100 | 63  | 0.018                  | 2220      | 5.0             | 3.0    | 5.7    | 50           | F161PP183(1)100(2) |
| 100 | 63  | 0.022                  | 2220      | 5.0             | 3.0    | 5.7    | 50           | F161PP223(1)100(2) |
| 100 | 63  | 0.027                  | 2220      | 5.0             | 3.0    | 5.7    | 50           | F161PP273(1)100(2) |
| 100 | 63  | 0.033                  | 2220      | 5.0             | 3.0    | 5.7    | 50           | F161PP333(1)100(2) |
| 100 | 63  | 0.039                  | 2220      | 5.0             | 3.0    | 5.7    | 50           | F161PP393(1)100(2) |
| 100 | 63  | 0.047                  | 2220      | 5.0             | 3.0    | 5.7    | 50           | F161PP473(1)100(2) |
| 100 | 63  | 0.056                  | 2220      | 5.0             | 3.0    | 5.7    | 50           | F161PP563(1)100(2) |
| 100 | 63  | 0.068                  | 2220      | 5.0             | 3.0    | 5.7    | 50           | F161PP683(1)100(2) |
| 100 | 63  | 0.082                  | 2220      | 5.0             | 4.0    | 5.7    | 50           | F161PU823(1)100(2) |
| 100 | 63  | 0.1                    | 2220      | 5.0             | 4.0    | 5.7    | 50           | F161PU104(1)100(2) |
| 100 | 63  | 0.01                   | 2824      | 6.0             | 3.0    | 7.3    | 50           | F161SL103(1)100(2) |
| 100 | 63  | 0.012                  | 2824      | 6.0             | 3.0    | 7.3    | 50           | F161SL123(1)100(2) |
| 100 | 63  | 0.015                  | 2824      | 6.0             | 3.0    | 7.3    | 50           | F161SL153(1)100(2) |
| 100 | 63  | 0.018                  | 2824      | 6.0             | 3.0    | 7.3    | 50           | F161SL183(1)100(2) |
| 100 | 63  | 0.022                  | 2824      | 6.0             | 3.0    | 7.3    | 50           | F161SL223(1)100(2) |
| 100 | 63  | 0.027                  | 2824      | 6.0             | 3.0    | 7.3    | 50           | F161SL273(1)100(2) |
| 100 | 63  | 0.033                  | 2824      | 6.0             | 3.0    | 7.3    | 50           | F161SL333(1)100(2) |
| 100 | 63  | 0.039                  | 2824      | 6.0             | 3.0    | 7.3    | 50           | F161SL393(1)100(2) |
| 100 | 63  | 0.047                  | 2824      | 6.0             | 3.0    | 7.3    | 50           | F161SL473(1)100(2) |
| 100 | 63  | 0.056                  | 2824      | 6.0             | 3.0    | 7.3    | 50           | F161SL563(1)100(2) |
| 100 | 63  | 0.068                  | 2824      | 6.0             | 3.0    | 7.3    | 50           | F161SL683(1)100(2) |
| 100 | 63  | 0.082                  | 2824      | 6.0             | 3.0    | 7.3    | 50           | F161SL823(1)100(2) |
| 100 | 63  | 0.1                    | 2824      | 6.0             | 3.0    | 7.3    | 50           | F161SL104(1)100(2) |
| 100 | 63  | 0.12                   | 2824      | 6.0             | 3.0    | 7.3    | 50           | F161SL124(1)100(2) |
| 100 | 63  | 0.15                   | 2824      | 6.0             | 3.5    | 7.3    | 50           | F161SP154(1)100(2) |
| 100 | 63  | 0.18                   | 2824      | 6.0             | 3.5    | 7.3    | 50           | F161SP184(1)100(2) |
| 100 | 63  | 0.22                   | 2824      | 6.0             | 4.5    | 7.3    | 50           | F161ST224(1)100(2) |
| 100 | 63  | 0.022                  | 4036      | 9.1             | 5.5    | 10.2   | 50           | F161WP223(1)100(2) |
| 100 | 63  | 0.027                  | 4036      | 9.1             | 5.5    | 10.2   | 50           | F161WP273(1)100(2) |
| 100 | 63  | 0.033                  | 4036      | 9.1             | 5.5    | 10.2   | 50           | F161WP333(1)100(2) |
| 100 | 63  | 0.039                  | 4036      | 9.1             | 5.5    | 10.2   | 50           | F161WP393(1)100(2) |
| 100 | 63  | 0.047                  | 4036      | 9.1             | 5.5    | 10.2   | 50           | F161WP473(1)100(2) |
| 100 | 63  | 0.056                  | 4036      | 9.1             | 5.5    | 10.2   | 50           | F161WP563(1)100(2) |
| 100 | 63  | 0.068                  | 4036      | 9.1             | 5.5    | 10.2   | 50           | F161WP683(1)100(2) |
| 100 | 63  | 0.082                  | 4036      | 9.1             | 5.5    | 10.2   | 50           | F161WP823(1)100(2) |
| 100 | 63  | 0.1                    | 4036      | 9.1             | 5.5    | 10.2   | 50           | F161WP104(1)100(2) |
| 100 | 63  | 0.12                   | 4036      | 9.1             | 5.5    | 10.2   | 50           | F161WP124(1)100(2) |
| 100 | 63  | 0.15                   | 4036      | 9.1             | 5.5    | 10.2   | 50           | F161WP154(1)100(2) |
| 100 | 63  | 0.18                   | 4036      | 9.1             | 5.5    | 10.2   | 50           | F161WP184(1)100(2) |
| 100 | 63  | 0.22                   | 4036      | 9.1             | 5.5    | 10.2   | 50           | F161WP224(1)100(2) |
| 100 | 63  | 0.27                   | 4036      | 9.1             | 5.5    | 10.2   | 50           | F161WP274(1)100(2) |
| 100 | 63  | 0.33                   | 4036      | 9.1             | 5.5    | 10.2   | 50           | F161WP334(1)100(2) |
| 100 | 63  | 0.39                   | 4036      | 9.1             | 5.5    | 10.2   | 50           | F161WP394(1)100(2) |
| 100 | 63  | 0.47                   | 4036      | 9.1             | 5.5    | 10.2   | 50           | F161WP474(1)100(2) |
| 100 | 63  | 0.56                   | 4036      | 9.1             | 5.5    | 10.2   | 50           | F161WP564(1)100(2) |
| 100 | 63  | 0.68                   | 4036      | 9.1             | 5.5    | 10.2   | 50           | F161WP684(1)100(2) |
| 100 | 63  | 0.82                   | 4036      | 9.1             | 5.5    | 10.2   | 50           | F161WP824(1)100(2) |
| 100 | 63  | 1                      | 4036      | 9.1             | 5.5    | 10.2   | 50           | F161WP105(1)100(2) |
| 100 | 63  | 1.2                    | 5045      | 11.5            | 6.5    | 12.7   | 50           | F161YR125(1)100(2) |
| VDC | VAC | Capacitance Value (µF) | Chip Size | B (mm)          | H (mm) | L (mm) | dV/dt (Vµs)  | Part Number        |

(1) J = ±5%, K = ±10%, M = ±20%, other tolerances on request.

(2) Insert ordering code for lead type and packaging. See Ordering Options Table for available options.

**Table 1 – Ratings & Part Number Reference cont.**

| VDC | VAC | Capacitance Value (µF) | Chip Size | Dimension in mm |     |      | dV/dt (V/µs) | Part Number        |
|-----|-----|------------------------|-----------|-----------------|-----|------|--------------|--------------------|
|     |     |                        |           | B               | H   | L    |              |                    |
| 100 | 63  | 1.5                    | 5045      | 11.5            | 6.5 | 12.7 | 50           | F161YR155(1)100(2) |
| 100 | 63  | 1.8                    | 5045      | 11.5            | 6.5 | 12.7 | 50           | F161YR185(1)100(2) |
| 100 | 63  | 2.2                    | 6560      | 15.0            | 7.0 | 16.5 | 50           | F161ZS225(1)100(2) |
| 100 | 63  | 2.7                    | 6560      | 15.0            | 7.0 | 16.5 | 50           | F161ZS275(1)100(2) |
| 100 | 63  | 3.3                    | 6560      | 15.0            | 7.0 | 16.5 | 50           | F161ZS335(1)100(2) |
| 100 | 63  | 3.9                    | 6560      | 15.0            | 7.0 | 16.5 | 50           | F161ZS395(1)100(2) |
| 100 | 63  | 4.7                    | 6560      | 15.0            | 7.0 | 16.5 | 50           | F161ZS475(1)100(2) |
| 250 | 160 | 0.01                   | 2824      | 6.0             | 3.0 | 7.3  | 150          | F161SL103(1)250(2) |
| 250 | 160 | 0.012                  | 2824      | 6.0             | 3.0 | 7.3  | 150          | F161SL123(1)250(2) |
| 250 | 160 | 0.015                  | 2824      | 6.0             | 3.0 | 7.3  | 150          | F161SL153(1)250(2) |
| 250 | 160 | 0.018                  | 2824      | 6.0             | 3.0 | 7.3  | 150          | F161SL183(1)250(2) |
| 250 | 160 | 0.022                  | 2824      | 6.0             | 3.0 | 7.3  | 150          | F161SL223(1)250(2) |
| 250 | 160 | 0.027                  | 2824      | 6.0             | 3.5 | 7.3  | 150          | F161SP273(1)250(2) |
| 250 | 160 | 0.033                  | 2824      | 6.0             | 3.5 | 7.3  | 150          | F161SP333(1)250(2) |
| 250 | 160 | 0.039                  | 2824      | 6.0             | 3.5 | 7.3  | 150          | F161SP393(1)250(2) |
| 250 | 160 | 0.047                  | 2824      | 6.0             | 4.5 | 7.3  | 150          | F161ST473(1)250(2) |
| 250 | 160 | 0.022                  | 4036      | 9.1             | 5.5 | 10.2 | 150          | F161WP223(1)250(2) |
| 250 | 160 | 0.027                  | 4036      | 9.1             | 5.5 | 10.2 | 150          | F161WP273(1)250(2) |
| 250 | 160 | 0.033                  | 4036      | 9.1             | 5.5 | 10.2 | 150          | F161WP333(1)250(2) |
| 250 | 160 | 0.039                  | 4036      | 9.1             | 5.5 | 10.2 | 150          | F161WP393(1)250(2) |
| 250 | 160 | 0.047                  | 4036      | 9.1             | 5.5 | 10.2 | 150          | F161WP473(1)250(2) |
| 250 | 160 | 0.056                  | 4036      | 9.1             | 5.5 | 10.2 | 150          | F161WP563(1)250(2) |
| 250 | 160 | 0.068                  | 4036      | 9.1             | 5.5 | 10.2 | 150          | F161WP683(1)250(2) |
| 250 | 160 | 0.082                  | 4036      | 9.1             | 5.5 | 10.2 | 150          | F161WP823(1)250(2) |
| 250 | 160 | 0.1                    | 4036      | 9.1             | 5.5 | 10.2 | 150          | F161WP104(1)250(2) |
| 250 | 160 | 0.12                   | 4036      | 9.1             | 5.5 | 10.2 | 150          | F161WP124(1)250(2) |
| 250 | 160 | 0.15                   | 4036      | 9.1             | 5.5 | 10.2 | 150          | F161WP154(1)250(2) |
| 250 | 160 | 0.18                   | 4036      | 9.1             | 5.5 | 10.2 | 150          | F161WP184(1)250(2) |
| 250 | 160 | 0.22                   | 4036      | 9.1             | 5.5 | 10.2 | 150          | F161WP224(1)250(2) |
| 250 | 160 | 0.27                   | 5045      | 11.5            | 6.5 | 12.7 | 150          | F161YR274(1)250(2) |
| 250 | 160 | 0.33                   | 5045      | 11.5            | 6.5 | 12.7 | 150          | F161YR334(1)250(2) |
| 250 | 160 | 0.39                   | 5045      | 11.5            | 6.5 | 12.7 | 150          | F161YR394(1)250(2) |
| 250 | 160 | 0.47                   | 5045      | 11.5            | 6.5 | 12.7 | 150          | F161YR474(1)250(2) |
| 250 | 160 | 0.56                   | 6560      | 15.0            | 7.0 | 16.5 | 150          | F161ZS564(1)250(2) |
| 250 | 160 | 0.68                   | 6560      | 15.0            | 7.0 | 16.5 | 150          | F161ZS684(1)250(2) |
| 250 | 160 | 0.82                   | 6560      | 15.0            | 7.0 | 16.5 | 150          | F161ZS824(1)250(2) |
| 250 | 160 | 1                      | 6560      | 15.0            | 7.0 | 16.5 | 150          | F161ZS105(1)250(2) |
| 400 | 200 | 0.022                  | 4036      | 9.1             | 5.5 | 10.2 | 200          | F161WP223(1)400(2) |
| 400 | 200 | 0.027                  | 4036      | 9.1             | 5.5 | 10.2 | 200          | F161WP273(1)400(2) |
| 400 | 200 | 0.033                  | 4036      | 9.1             | 5.5 | 10.2 | 200          | F161WP333(1)400(2) |
| 400 | 200 | 0.039                  | 4036      | 9.1             | 5.5 | 10.2 | 200          | F161WP393(1)400(2) |
| 400 | 200 | 0.047                  | 4036      | 9.1             | 5.5 | 10.2 | 200          | F161WP473(1)400(2) |
| 400 | 200 | 0.056                  | 4036      | 9.1             | 5.5 | 10.2 | 200          | F161WP563(1)400(2) |
| 400 | 200 | 0.068                  | 4036      | 9.1             | 5.5 | 10.2 | 200          | F161WP683(1)400(2) |
| 400 | 200 | 0.082                  | 5045      | 9.1             | 5.5 | 10.2 | 200          | F161WP823(1)400(2) |
| 400 | 200 | 0.1                    | 5045      | 11.5            | 6.5 | 12.7 | 200          | F161YR104(1)400(2) |
| 400 | 200 | 0.12                   | 5045      | 11.5            | 6.5 | 12.7 | 200          | F161YR124(1)400(2) |
| 400 | 200 | 0.15                   | 5045      | 11.5            | 6.5 | 12.7 | 200          | F161YR154(1)400(2) |
| 400 | 200 | 0.18                   | 5045      | 11.5            | 6.5 | 12.7 | 200          | F161YR184(1)400(2) |
| 400 | 200 | 0.22                   | 6560      | 15.0            | 7.0 | 16.5 | 200          | F161ZS224(1)400(2) |
| 400 | 200 | 0.27                   | 6560      | 15.0            | 7.0 | 16.5 | 200          | F161ZS274(1)400(2) |
| 400 | 200 | 0.33                   | 6560      | 15.0            | 7.0 | 16.5 | 200          | F161ZS334(1)400(2) |
| 400 | 200 | 0.39                   | 6560      | 15.0            | 7.0 | 16.5 | 200          | F161ZS394(1)400(2) |
| 400 | 200 | 0.47                   | 6560      | 15.0            | 7.0 | 16.5 | 200          | F161ZS474(1)400(2) |
| 630 | 250 | 0.1                    | 6560      | 15.0            | 7.0 | 16.5 | 250          | F161ZS104(1)630(2) |
| 630 | 250 | 0.12                   | 6560      | 15.0            | 7.0 | 16.5 | 250          | F161ZS124(1)630(2) |
| 630 | 250 | 0.15                   | 6560      | 15.0            | 7.0 | 16.5 | 250          | F161ZS154(1)630(2) |
| 630 | 250 | 0.18                   | 6560      | 15.0            | 7.0 | 16.5 | 250          | F161ZS184(1)630(2) |

(1) J = ±5%, K = ±10%, M = ±20%, other tolerances on request.

(2) Insert ordering code for lead type and packaging. See Ordering Options Table for available options.



## Soldering Process

**Reflow soldering temperature is measured on the top surface of the component:** Preheating temperature should be less than 170°C. The time above 217°C should be less than 50 seconds. The peak temperature must not exceed 240°C.

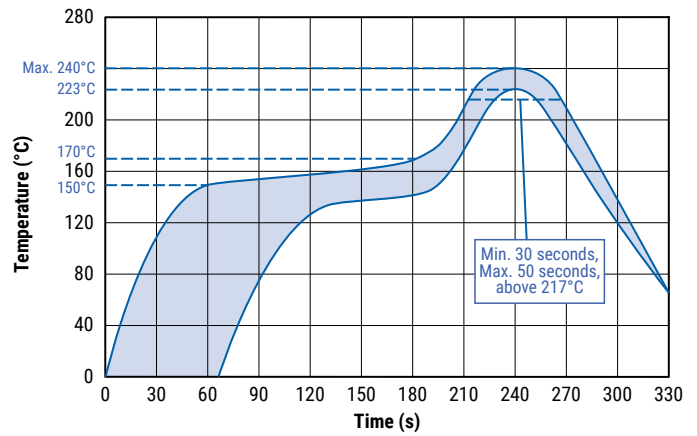

## Construction

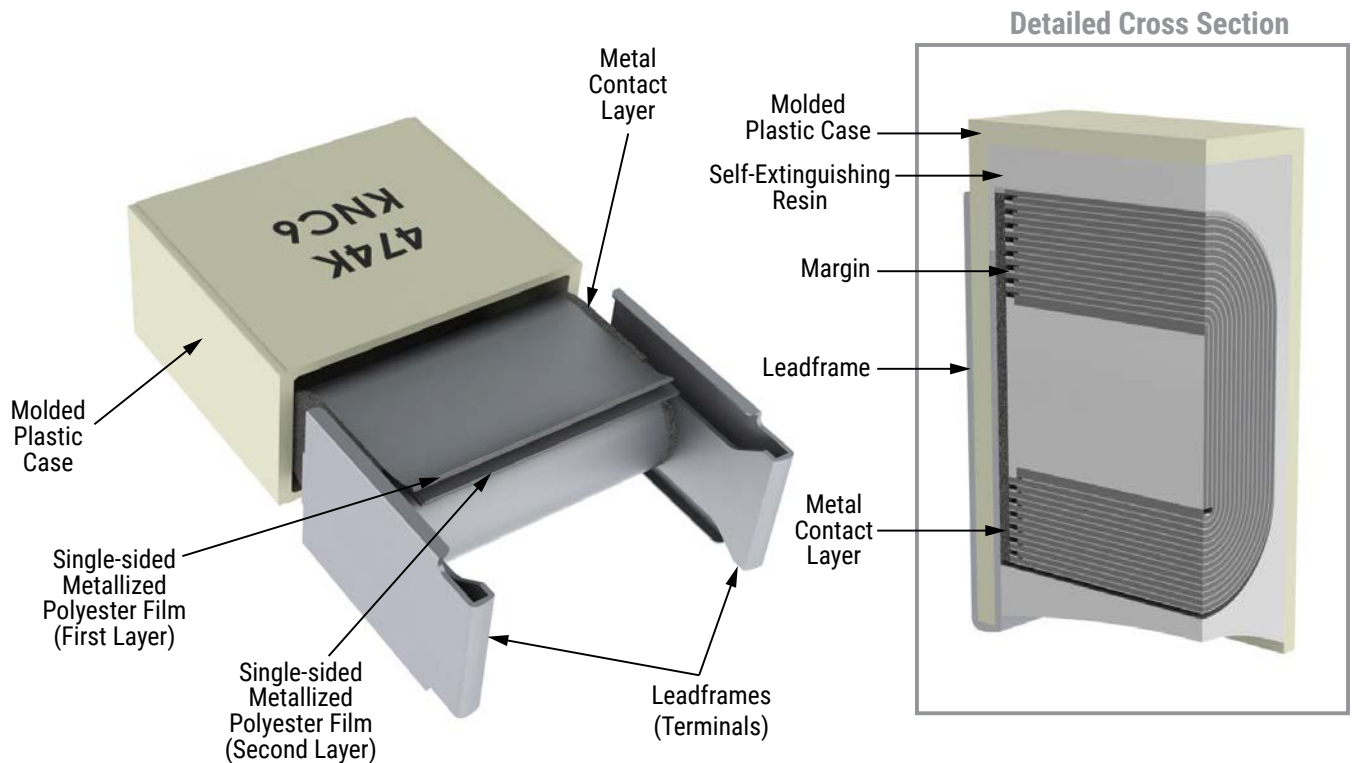

## Marking

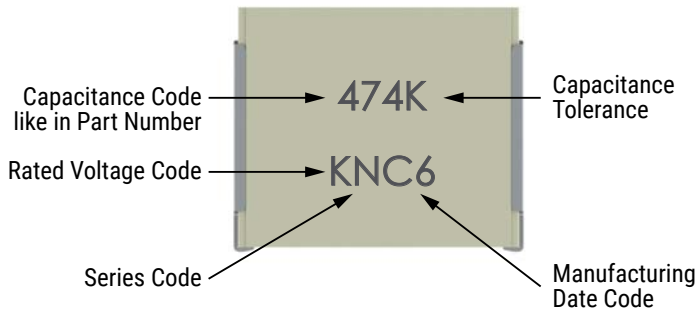

| Rated Voltage | Code |
|---------------|------|
| 50 VDC        | Z    |
| 63 VDC        | C    |
| 100 VDC       | D    |
| 250 VDC       | H    |
| 400 VDC       | K    |
| 630 VDC       | M    |

| Manufacturing Date Code (IEC 60062) |      |           |      |
|-------------------------------------|------|-----------|------|
| Year                                | Code | Month     | Code |
| 2010                                | A    | January   | 1    |
| 2011                                | B    | February  | 2    |
| 2012                                | C    | March     | 3    |
| 2013                                | D    | April     | 4    |
| 2014                                | E    | May       | 5    |
| 2015                                | F    | June      | 6    |
| 2016                                | H    | July      | 7    |
| 2017                                | J    | August    | 8    |
| 2018                                | K    | September | 9    |
| 2019                                | L    | October   | 0    |
| 2020                                | M    | November  | N    |
| 2021                                | N    | December  | D    |
| 2022                                | P    |           |      |
| 2023                                | R    |           |      |
| 2024                                | S    |           |      |
| 2025                                | T    |           |      |
| 2026                                | U    |           |      |
| 2027                                | V    |           |      |
| 2028                                | W    |           |      |
| 2029                                | X    |           |      |
| 2030                                | A    |           |      |

## Flux & Cleaning

KEMET recommends using a no-clean flux with a halogen content lower than 0.1%.

To clean the PCB assembly KEMET recommends to use a suitable solvent like Isopropyl alcohol, deionized water, or neutral pH detergents. Aggressive solvents shall not be used. For any different cleaning solvent used please contact KEMET Technical Services to analyze the potential impact on KEMET products.

## Storage and Moisture Recommendations

KEMET SMD Film Capacitors are supplied in a MBB (Moisture Barrier Bag) Class 1. We can guarantee a 24 month shelf life (temperature  $\leq 40^{\circ}\text{C}$ /relative humidity  $\leq 90\%$ ). After the MBB has been opened, components may stay in areas with controlled temperature and humidity (temperature  $\leq 30^{\circ}\text{C}$ /relative humidity  $\leq 60\%$ ) for 168 hours [MSL 3]. For longer periods of time and/or higher temperature and/or higher relative humidity values, it is absolutely necessary to protect the components against humidity. If the reel inside the MBB is partially used, KEMET recommends to re-use the same MBB or to avoid areas without controlled temperature and humidity (see above). If the above conditions are not respected, components require a baking (minimum time: 48 hours at  $55 \pm 5^{\circ}\text{C}$ ) before the reflow.

## Packaging Quantities

| Chip Size (EIA) | Size Code | Base (mm) | Height (mm) | Length (mm) | Bulk  | Reel Horizontal Orientation | Reel Vertical Orientation |
|-----------------|-----------|-----------|-------------|-------------|-------|-----------------------------|---------------------------|
| 2220            | PP        | 5.0       | 3.0         | 5.7         | 2,000 | 2,400                       |                           |
| 2220            | PU        | 5.0       | 4.0         | 5.7         | 2,000 | 2,100                       |                           |
| 2824            | SL        | 6.0       | 3.0         | 7.3         | 2,000 | 2,500                       |                           |
| 2824            | SP        | 6.0       | 3.5         | 7.3         | 2,000 | 2,300                       |                           |
| 2824            | ST        | 6.0       | 4.5         | 7.3         | 1,000 | 1,700                       |                           |
| 4036            | WP        | 9.1       | 5.5         | 10.2        | 1,000 | 800                         | 500                       |
| 5045            | YR        | 11.5      | 6.5         | 12.7        | 1,000 | 600                         | 400                       |
| 6560            | ZS        | 15.0      | 7.0         | 16.5        | 800   | 500                         | 200                       |

## Landing

| Mounting   | Chip Size | Dimensions in mm |     |     |
|------------|-----------|------------------|-----|-----|
|            |           | A                | B   | X   |
| Horizontal | 2220      | 5.1              | 1.5 | 3.0 |
|            | 2824      | 6.1              | 1.5 | 3.8 |
|            | 4036      | 9.1              | 2.0 | 5.5 |
|            | 5045      | 11.6             | 2.5 | 7.0 |
|            | 6560      | 15.0             | 3.0 | 9.0 |
| Vertical   | 4022      | 5.6              | 2.0 | 5.5 |
|            | 5026      | 6.6              | 2.5 | 7.0 |
|            | 6528      | 7.1              | 3.0 | 9.0 |

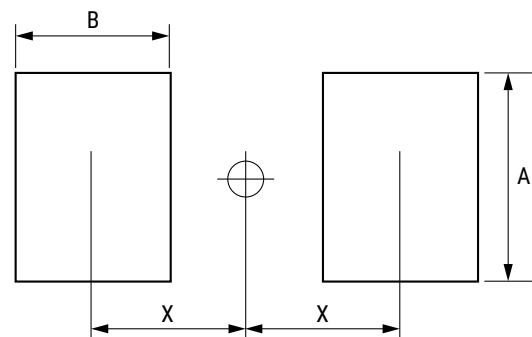

## Carrier Taping & Packaging (IEC 60286-2)

### Horizontal Taping Orientation

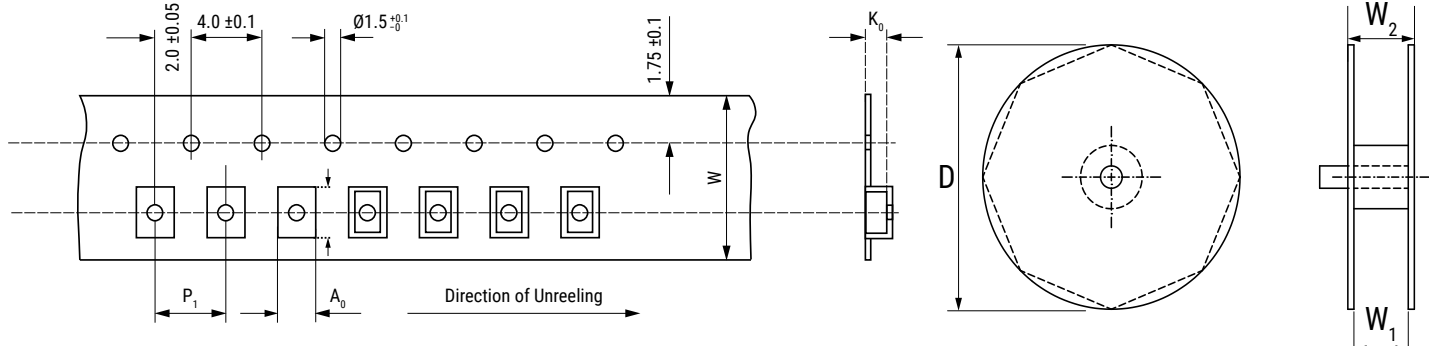

| EIA Size Code<br>Horizontal Mounting | Size Code | Dimensions in mm |         |         | Taping Specification |                |                |                |                |      |                |                |
|--------------------------------------|-----------|------------------|---------|---------|----------------------|----------------|----------------|----------------|----------------|------|----------------|----------------|
|                                      |           | B                | H       | L       | W                    | P <sub>1</sub> | A <sub>0</sub> | B <sub>0</sub> | K <sub>0</sub> | D    | W <sub>1</sub> | W <sub>2</sub> |
|                                      |           | Nominal          | Nominal | Nominal | -0/+0.3              | ±0.1           | Nominal        | Nominal        | Nominal        | ±2.0 | -0/+2          | Maximum        |
| 2220                                 | PP        | 5.0              | 3.0     | 5.7     | 12.0                 | 8.0            | 5.5            | 6.0            | 3.3            | 330  | 12.4           | 22.0           |
| 2220                                 | PU        | 5.0              | 4.0     | 5.7     | 12.0                 | 8.0            | 5.5            | 6.0            | 4.3            | 330  | 12.4           | 22.0           |
| 2824                                 | SL        | 6.0              | 3.0     | 7.3     | 12.0                 | 8.0            | 6.5            | 7.5            | 3.3            | 330  | 12.4           | 22.0           |
| 2824                                 | SP        | 6.0              | 3.5     | 7.3     | 12.0                 | 8.0            | 6.5            | 7.5            | 3.8            | 330  | 12.4           | 22.0           |
| 2824                                 | ST        | 6.0              | 4.5     | 7.3     | 12.0                 | 8.0            | 6.5            | 7.5            | 4.8            | 330  | 12.4           | 22.0           |
| 4036                                 | WP        | 9.1              | 5.5     | 10.2    | 16.0                 | 16.0           | 9.5            | 10.5           | 5.8            | 330  | 16.4           | 22.0           |
| 5045                                 | YR        | 11.5             | 6.5     | 12.7    | 24.0                 | 16.0           | 11.9           | 13.1           | 6.8            | 330  | 24.4           | 30.0           |
| 6560                                 | ZS        | 15.0             | 7.0     | 16.5    | 24.0                 | 20.0           | 15.4           | 16.8           | 7.3            | 330  | 24.4           | 30.0           |

## Carrier Taping & Packaging (IEC 60286-2) cont.

### Vertical Taping Orientation

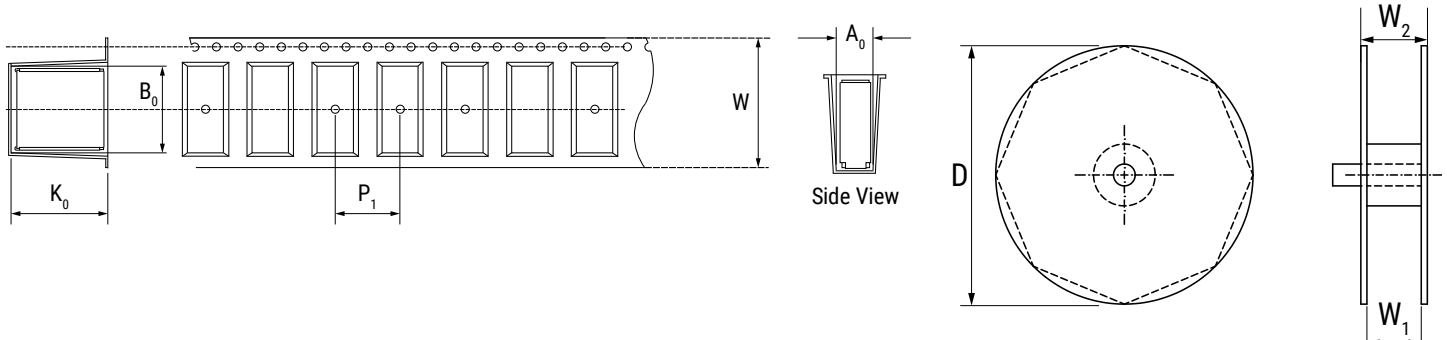

| Size Code<br>Vertical<br>Mounting | Size Code | Dimensions in mm |         |         | Taping Specification |                |                |                |                |      |                |                |
|-----------------------------------|-----------|------------------|---------|---------|----------------------|----------------|----------------|----------------|----------------|------|----------------|----------------|
|                                   |           | B                | H       | L       | W                    | P <sub>1</sub> | A <sub>0</sub> | B <sub>0</sub> | K <sub>0</sub> | D    | W <sub>1</sub> | W <sub>2</sub> |
|                                   |           | Nominal          | Nominal | Nominal | -0/+0.3              | ±0.1           | Nominal        | Nominal        | Nominal        | ±2.0 | -0/+2          | Maximum        |
| 4022                              | WP        | 5.5              | 9.1     | 10.2    | 24.0                 | 16.0           | 6.0            | 10.5           | 9.3            | 330  | 24.4           | 30.0           |
| 5026                              | YR        | 6.5              | 11.5    | 12.7    | 24.0                 | 16.0           | 6.9            | 13.1           | 11.8           | 330  | 24.4           | 30.0           |
| 6528                              | ZS        | 7.0              | 15.0    | 16.5    | 44.0                 | 20.0           | 7.5            | 17.0           | 15.3           | 330  | 44.5           | 49.5           |

**Note: Chip dimensions B and H correspond to dimensions H and B in the horizontal mounting table.**

## KEMET Electronics Corporation Sales Offices

For a complete list of our global sales offices, please visit [www.kemet.com/sales](http://www.kemet.com/sales).

---

### Disclaimer

All product specifications, statements, information and data (collectively, the "Information") in this datasheet are subject to change. The customer is responsible for checking and verifying the extent to which the Information contained in this publication is applicable to an order at the time the order is placed. All Information given herein is believed to be accurate and reliable, but it is presented without guarantee, warranty, or responsibility of any kind, expressed or implied.

Statements of suitability for certain applications are based on KEMET Electronics Corporation's ("KEMET") knowledge of typical operating conditions for such applications, but are not intended to constitute – and KEMET specifically disclaims – any warranty concerning suitability for a specific customer application or use. The Information is intended for use only by customers who have the requisite experience and capability to determine the correct products for their application. Any technical advice inferred from this Information or otherwise provided by KEMET with reference to the use of KEMET's products is given gratis, and KEMET assumes no obligation or liability for the advice given or results obtained.

Although KEMET designs and manufactures its products to the most stringent quality and safety standards, given the current state of the art, isolated component failures may still occur. Accordingly, customer applications which require a high degree of reliability or safety should employ suitable designs or other safeguards (such as installation of protective circuitry or redundancies) in order to ensure that the failure of an electrical component does not result in a risk of personal injury or property damage.

Although all product-related warnings, cautions and notes must be observed, the customer should not assume that all safety measures are indicated or that other measures may not be required.

*KEMET is a registered trademark of KEMET Electronics Corporation.*

## X-ON Electronics

Largest Supplier of Electrical and Electronic Components

*Click to view similar products for [Film Capacitors](#) category:*

*Click to view products by [Kemet](#) manufacturer:*

Other Similar products are found below :

[F339X134748MIP2T0](#) [F450KG153J250ALH0J](#) [750-1018](#) [FKP1-1500160010P15](#) [FKP1R031007D00JYSD](#) [FKP1R031507E00JYSD](#)  
[FKP1U024707E00KYSD](#) [82DC4100CK60J](#) [82EC1100DQ50K](#) [PFR5101J100J11L16.5TA18](#) [PME261JB5220KR19T0](#) [A451GK223M040A](#)  
[A561ED221M450A](#) [QXJ2E474KTPT](#) [QXL2B333KTPT](#) [R49AN347000A1K](#) [EEC2G505HQA406](#) [B25668A6676A375](#) [B25673A4282E140](#)  
[BFC233868148](#) [BFC2370GC222](#) [C3B2AD44400B20K](#) [C4ASWBU3220A3EK](#) [CB027C0473J--](#) [CB177I0184J--](#) [CB182K0184J--](#) [23PW210](#)  
[950CQW5H-F](#) [SBDC3470AA10J](#) [SCD105K122A3-22](#) [2N3155](#) [A571EH331M450A](#) [FKP1-2202KV5P15](#) [FKS3-680040010P10](#)  
[QXL2E473KTPT](#) [445450-1](#) [B25669A3996J375](#) [46KI322000M1M](#) [46KR415050M1K](#) [4BSNBX4100ZBFJ](#) [MKP383510063JKP2T0](#)  
[MKPY2-.02230020P15](#) [MKT 1813-368-015](#) [4055292001](#) [46KN410000N1K](#) [EEC2E106HQA405](#) [EEC2G205HQA402](#) [EEC2G805HQA415](#)  
[P409CP224M250AH470](#) [82EC2150DQ50K](#)