

General purpose Chassis and PCB mount

A series of compact, high performance, low leakage PCB and chassis mount suppression filters - with multiple combinations of enclosure size, current ratings and termination styles. This range offers flexibility and economy. Typical applications include industrial measuring equipment, consumer electronics and low power SMPS.

- Current ratings from 0.5A to 10A
- Compact PCB or chassis mount footprint
- Low profile variants (FAH)
- PCB or fast-on terminations
- Medical versions available



Mechanical Specifications

Manufacture: plastic case sealed with self-extinguishing resin.

Connections: for PCB mounting (FA-AV) or with faston 2.8x0.5mm (FA-AA FA-DA)

Electrical Specifications

Rated voltage (V_R): max 250V, 50/60Hz

Rated current (I_R): referred to room temperature = 40°C





Leakage current (I_L): at 220V, 50Hz, max value

Voltage test (2 s.): line to ground 3000Vdc or 1800Vac
line to line 1700Vdc

Climatic category: HPF (25/085/21);
Temperature range: -25°C to +85°C

Filter Range

Code	I_R (A)	L (mH)	Cx (μ F)	Cy (pF)	I_L (mA)	R (M Ω)	Circ Diag
FAH -- 3100ZA	0.5	2x40	0.1	2x2500	2x0.23		A ●
FAH -- 3100ZB	1	2x10	0.1	2x2500	2x0.23		A ●
FAH -- 3100ZC	1.6	2x6	0.1	2x2500	2x0.23		A ●
FAH -- 3100ZD	2.5	2x2	0.1	2x2500	2x0.23		A ●
FAH -- 3100ZE	4	2x1	0.1	2x2500	2x0.23		A ●
FAH -- 3100ZF	6.5	2x1	0.1	2x2500	2x0.23		A ●
▲ FAH -- 3100ZG	5	2x2	0.1	2x2500	2x0.23		A ●
▲ FAH -- 3100ZK	0.5	2x40	0.1	2x4700	2x0.43		A ●
▲ FAH -- 3100ZL	1	2x10	0.1	2x4700	2x0.43		A ●
▲ FAH -- 3100ZM	1.6	2x6	0.1	2x4700	2x0.43		A ●
▲ FAH -- 3100ZN	2.5	2x2	0.1	2x4700	2x0.43		A ●
▲ FAH -- 3100ZP	6.5	2x1	0.1	2x4700	2x0.43		A ●
FAH -- 3200ZA	0.5	2x40	2x0.1		2x0.02		E
FAH -- 3200ZB	1	2x10	2x0.1		2x0.02		E
FAH -- 3200ZC	1.6	2x6	2x0.1		2x0.02		E
FAH -- 3200ZD	2.5	2x2	2x0.1		2x0.02		E
FAH -- 3200ZE	4	2x1	2x0.1		2x0.02		E
FAH -- 3200ZF	6.5	2x1	2x0.1		2x0.02		E
■ FAA -- 3100ZA	10	2x1	0.1	2x2500	2x0.23	1	A
▲ FAA -- 3100ZB	1	2x10	0.1	2x2500	2x0.23		A
▲ FAA -- 3220ZB	0.5	2x40	0.22	2x2200	2x0.20	1.5	B
▲ FAA -- 3220ZC	6.5	2x1	0.22	2x2500	2x0.23	1	A
▲ FAA -- 3330ZA	0.5	2x40	0.33	2x4700	2x0.43	1	C
▲ FAA -- 3680ZA	0.5	2x40	0.68	2x4700	2x0.43	0.47	C

 A = Faston 2.8 x 0.5mm
 V = for PCB mounting
 A = Case without brackets
 D = Case with brackets

▲ No approvals. ● Also available in circuit B on request, no approvals. ■ VDE approved only.

* other variants on request

Dimensions (mm) and connections

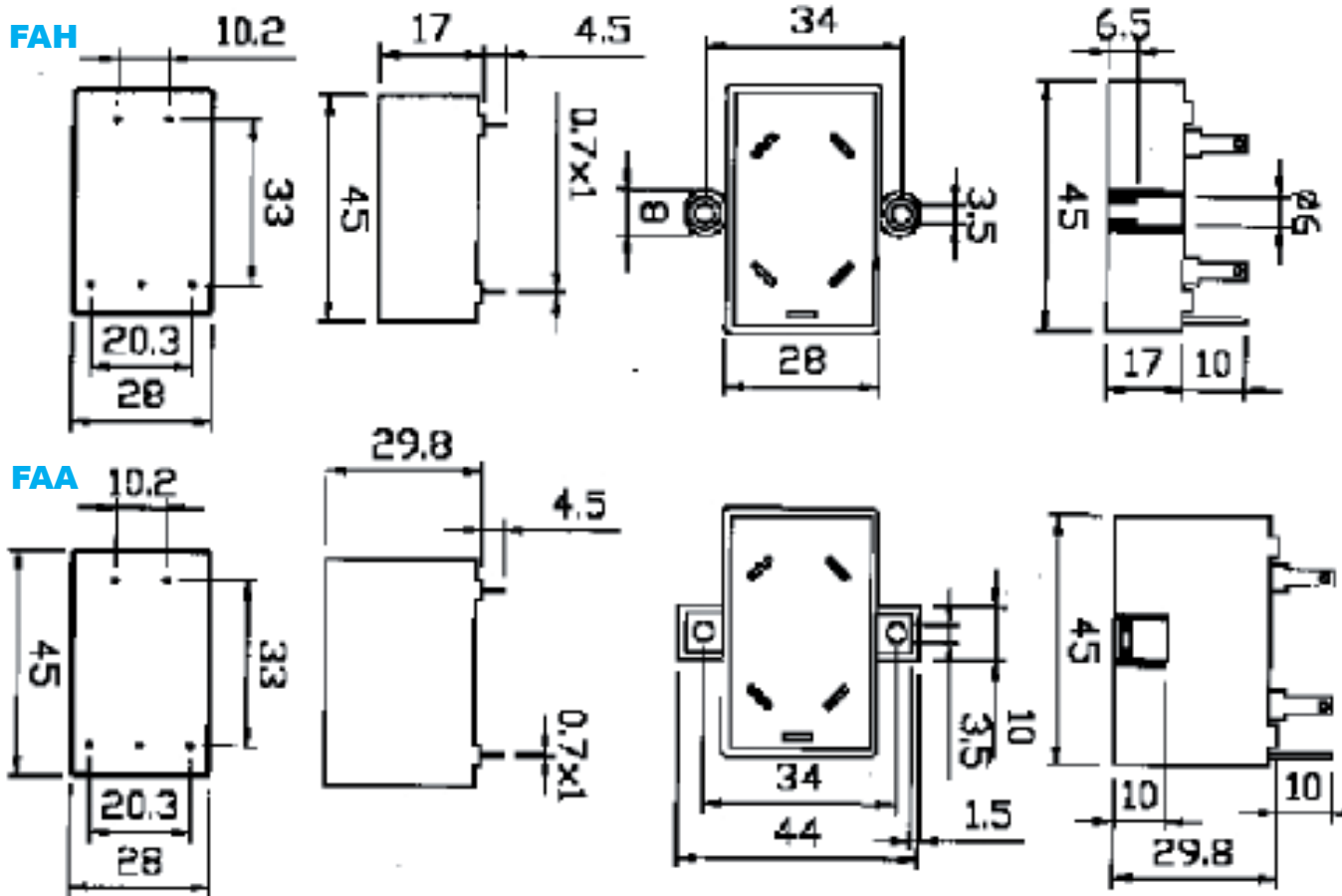

Circuit diagram

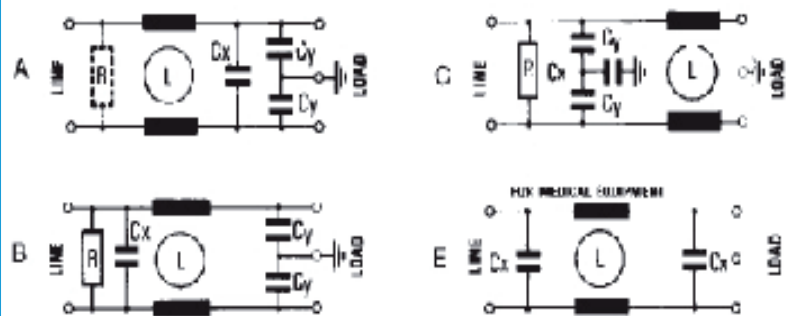

Insertion loss (typical): — Asymmetrical (line to ground) - - - Symmetrical (line to line)

FAH

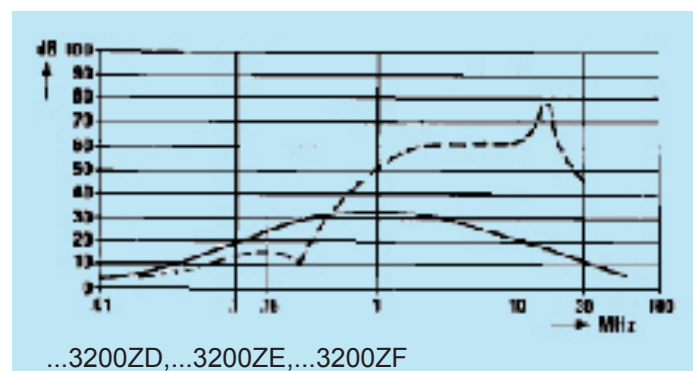
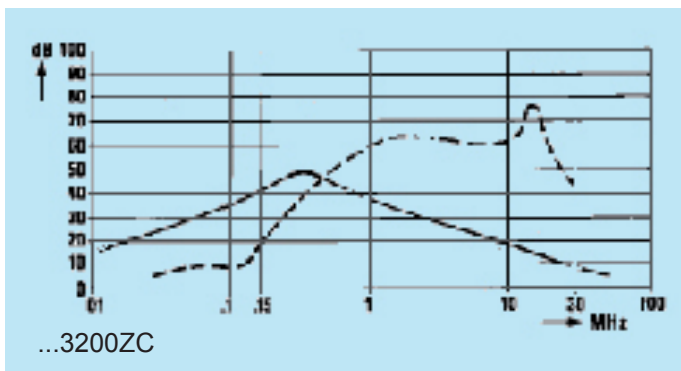
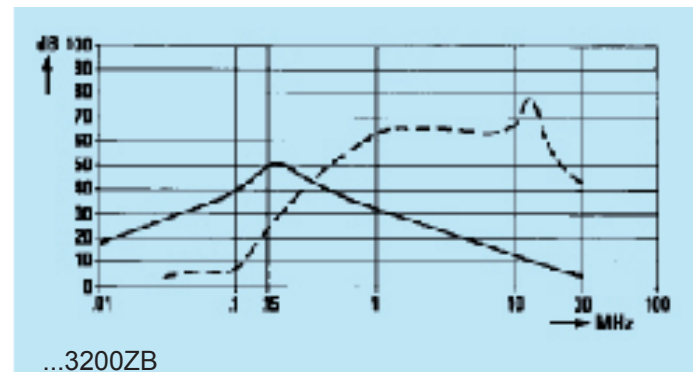
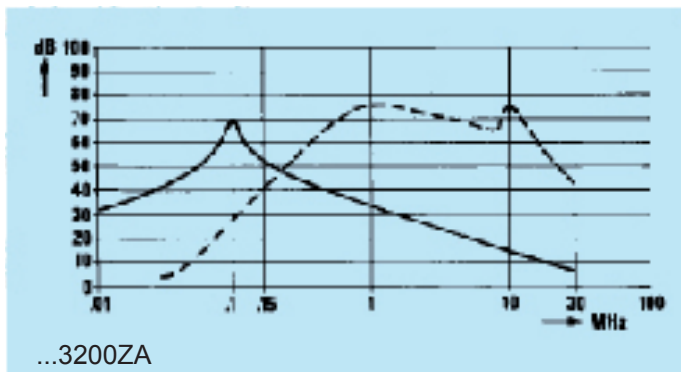
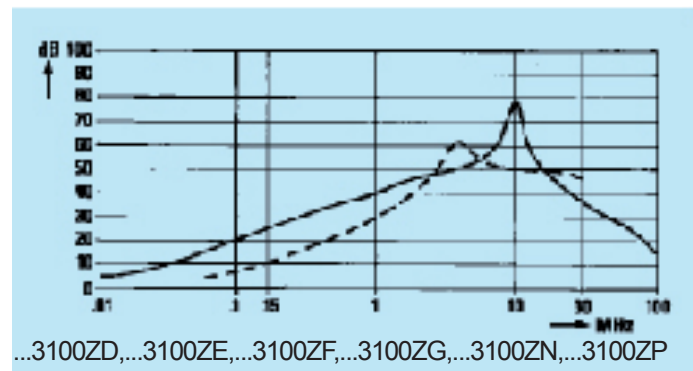
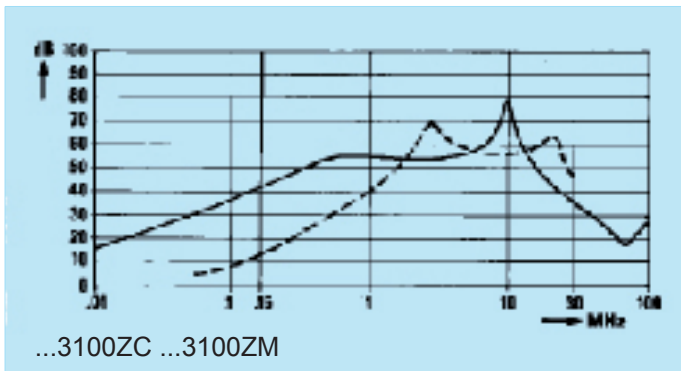
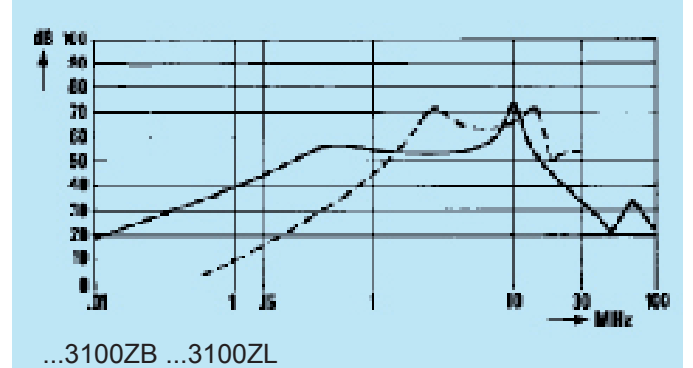
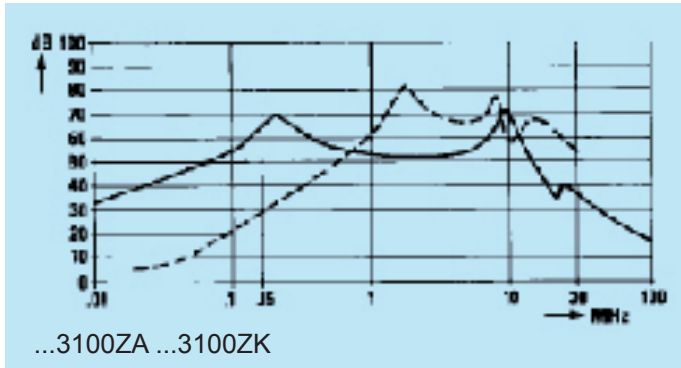

Insertion loss (typical): — Asymmetrical (line to ground) - - - Symmetrical (line to line)

FAA

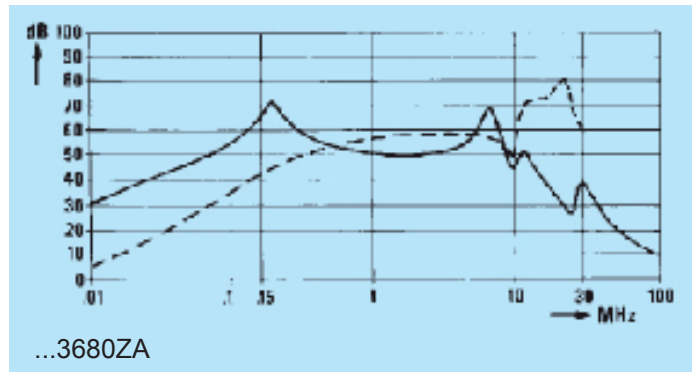
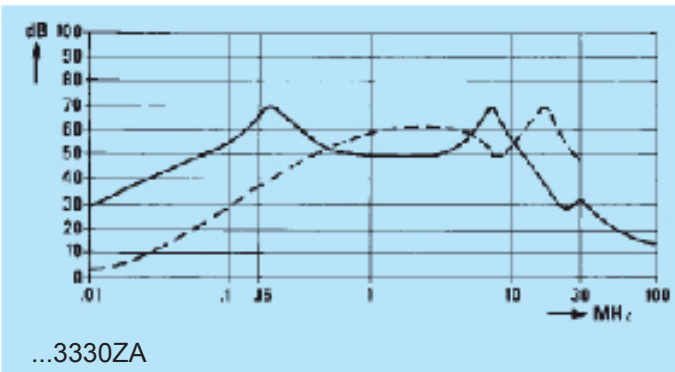
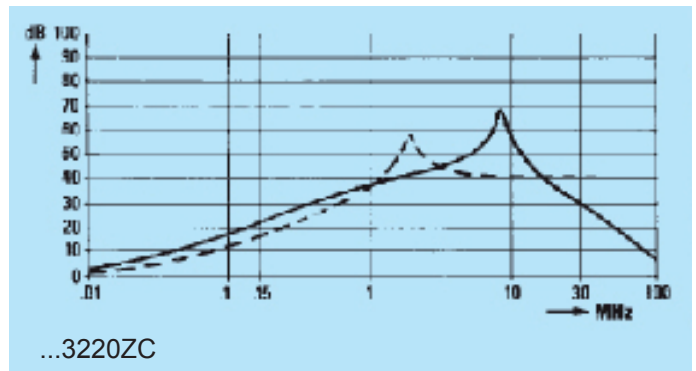
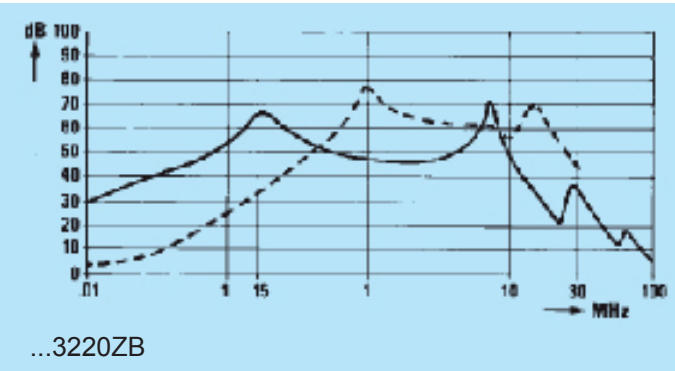
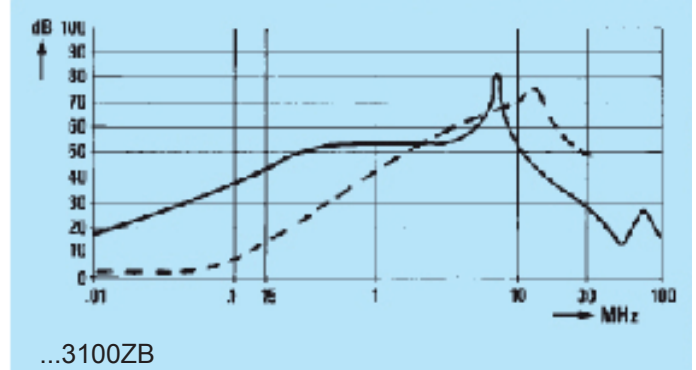
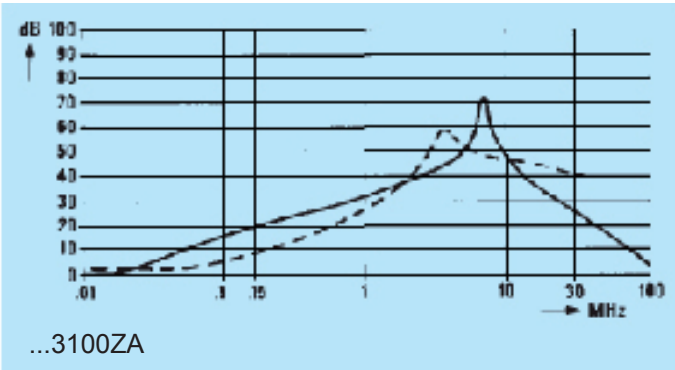

High performance

This range provides a high level of performance within compact metal enclosures for printed circuit board configurations.

Specifically designed to protect against symmetric, asymmetric, periodic and pulse shaped RFI.

Ideal for use with office equipment, telecom products, computers and industrial applications.

- Current ratings from 3A to 16A
- PCM mount termination
- High RFI attenuation
- Single or two stage circuit designs
- Medical versions available

Mechanical Specifications

Manufacture: metal case sealed with self-extinguishing resin.
 Connections: for PCB mounting; ground terminal connected to case.

Filter Range

Code	I _R (A)	L (mH)	L ₁ (mH)	Cx ₁ (μF)	Cx ₂ (μF)	Cy1 (pF)	Cy2 (pF)	I _L (mA)	R (MΩ)	Circ diag
FAMAV3600ZC010	16	2x1			0.6	2x2500		2x0.23	1	A
▲ FAMAV3600ZI010	16	2x1			0.6	2x6800		2x0.62	1	A
FAMAV3940ZA	3.3	2x13		0.47	0.47	2x6800		2x0.62	0.33	B
FAMAV3940ZB001	3.3	2x13	2x1	0.47	0.47	2x6800	2x1000	2x.072	0.68	C

▲ UL approval only
 * other variants on request

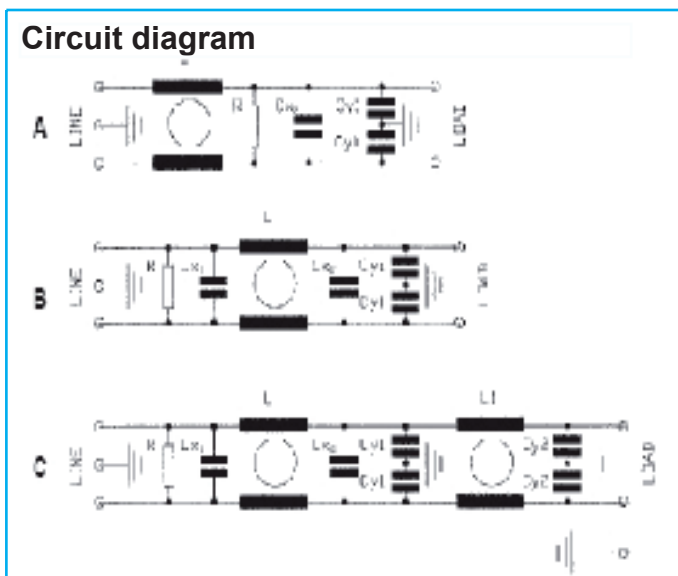

Electrical Specifications

Rated voltage (V_R): max 250V, 50/60Hz
 Rated current (I_R): referred to room temperature = 40°C
 Leakage current (I_L): at 220V, 50Hz, max value
 Voltage test (2 s.): line to ground 3000Vdc or 1800Vac
 line to line 1700Vdc
 Climatic category: HPF (25/085/21);
 Temperature range: -25°C to +85°C

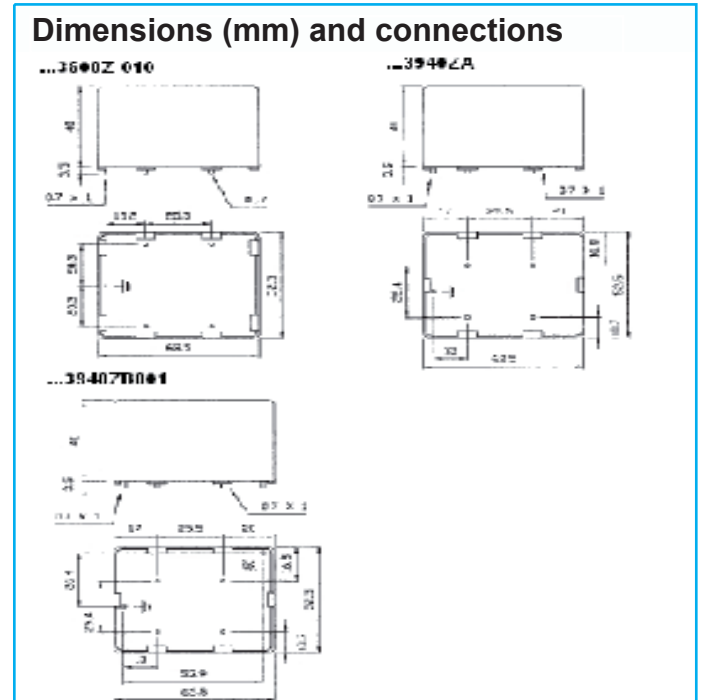

Approvals



in progress



1283



22.2 N°8



Insertion loss (typical): — Asymmetrical (line to ground) - - - Symmetrical (line to line)

FAMAV

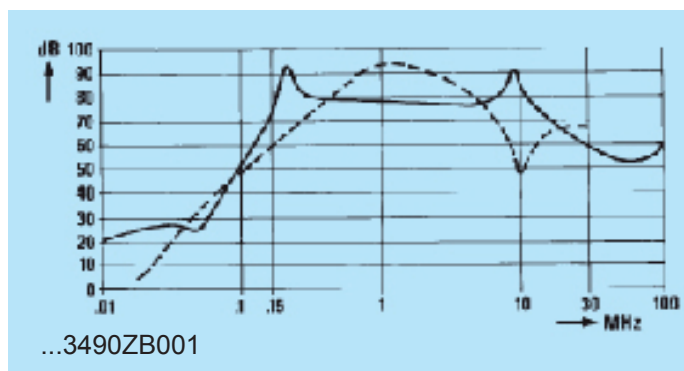
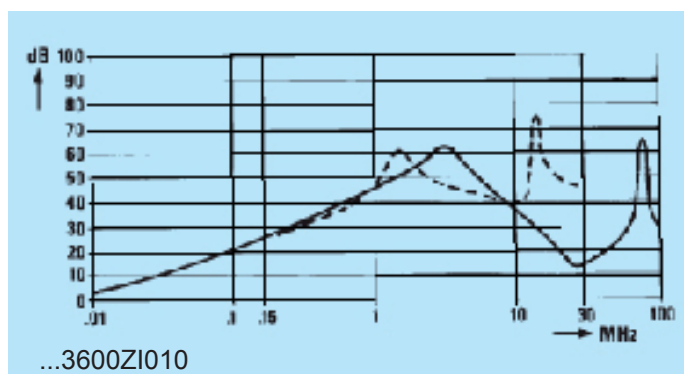
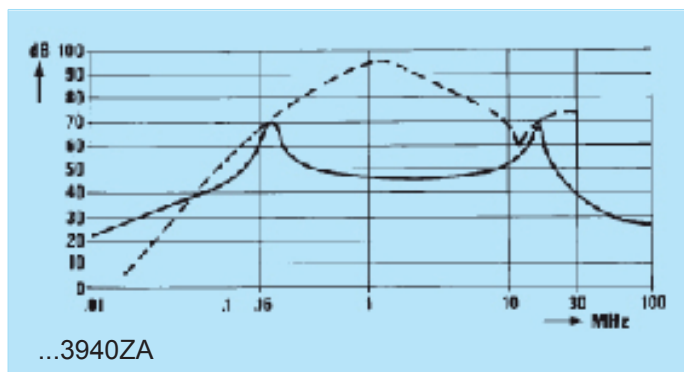
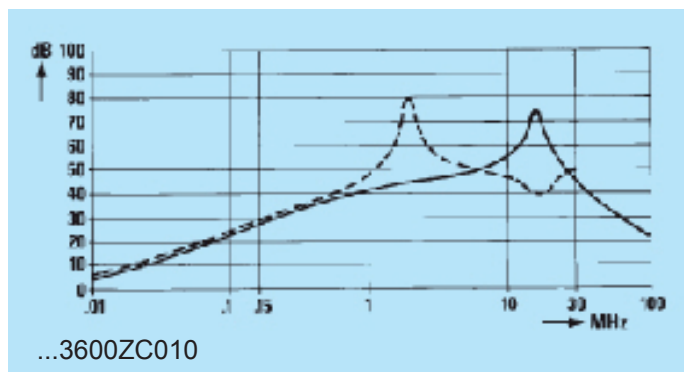

X-ON Electronics

Largest Supplier of Electrical and Electronic Components

Click to view similar products for [Power Line Filters](#) category:

Click to view products by [Kemet](#) manufacturer:

Other Similar products are found below :

[6609019-3](#) [6609026-5](#) [6609030-6](#) [6609973-2](#) [D30A](#) [7-1609090-5](#) [F2810](#) [F4456A](#) [F7382Z](#) [F7863Z](#) [FAHAV3100ZC000](#) [806276](#) [FN2020B-1-06](#) [FN2080B-10-06](#) [FN2410H-32-33](#) [FP144](#) [FS4153-20-06](#) [FS4353-500-99](#) [12-MMB-030-11-D](#) [DB4-393](#) [15811T200](#) [20B1](#) [LC630](#) [2B1](#) [1609080-2](#) [1609993-8](#) [1-6609070-1](#) [F1100AA02](#) [F1150CC10](#) [F1500CA10](#) [F1500CA15](#) [F4041Z](#) [F7585E](#) [1B1](#) [FN2070A-16-06](#) [FN2090A-20-06](#) [FN2090B-12-06](#) [FN2090Z-1-06](#) [FN2410H-25-33](#) [FN2410H-60-34](#) [FN2410H-8-44](#) [FN2412H-8-44](#) [FN323B-6-01](#) [FN3258H-130-35](#) [FN610R-3-06](#) [20EHQ7](#) [20EHZ7](#) [20K1](#) [30B6](#) [3K1](#)