

FLLE2 – Q, Single Phase General Purpose Chassis Mount Filters

Overview

The FLLE2-Q is a general purpose, single phase filter series with medium/high attenuation. They have a chassis mount for fast mounting and a metal case filled with self-extinguishing resin. Fast-on or screw terminals, and options with flexible wire connections are available. In addition, medical versions are available without Y-capacitors for no leakage current.

Applications

Typical applications include industrial power supplies, office and business equipment, tele- and datacom equipment, household and consumer goods, and medical equipment.



Technical Specifications

Item	Parameters/ Characteristics
Rated Voltage	300 VAC/VDC
Rated Frequency	50 – 60 Hz
Rated Current	1 – 32 A
Rated Temperature	40°C
Temperature Range	-25°C to 100°C
Climate Category	25/100/21
Voltage Test	P → N 1,300 VDC P/N → E 2,250 VDC

Typical Electrical Schematic

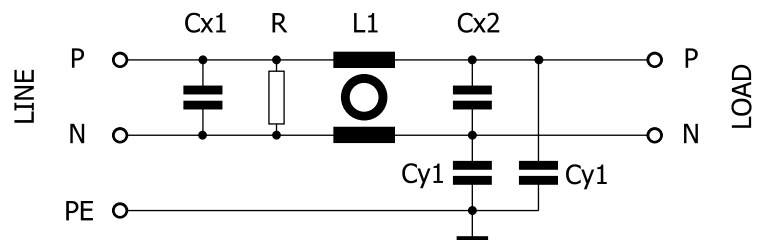

Technical Specifications cont.

Part Number	Rated Current at 40°C (A)	Leakage Current* (mA)	C _{x1} (μF)	R (MΩ)	L1 (mH)	C _{y1} (nF)	C _{x2} (μF)
FLLE2001AQ(1)(2)	1	0.37	0.15	1	12	4.7	0.15
FLLE2003AQ(1)(2)	3	0.37	0.15	1	2.5	4.7	0.15
FLLE2006AQ(1)(2)	6	0.37	0.15	1	1	4.7	0.15
FLLE2010AQ(1)(2)	10	0.37	0.15	1	1	4.7	0.15
FLLE2013AQ(1)(2)	13	0.37	0.15	1	0.8	4.7	0.15
FLLE2016AQ(1)(2)	16	0.37	0.15	1	0.8	4.7	0.15
FLLE2020AQ(1)(2)	20	0.37	0.15	1	0.8	4.7	0.15
FLLE2025AQ(1)(2)	25	0.37	0.15	1	0.8	4.7	0.15
FLLE2032AQ(1)(2)	32	0.79	0.68	0.22	0.8	10	0.68

(1) D = Standard, M = Medical

(2) B = Fast-on (1-16A), I = Threaded (20-32A), D = Wire (1-32A)

* Leakage current at 250 VAC/50 Hz according to IEC60939-3. Medical version without C_y-capacitors, no leakage current.

Approvals

Standard	Certification Body	File Number
IEC/EN 60939-3	UL-Demko	E490803
ANSI/UL 60939-3-2017	UL	E490803
CAN/CSA C22.2 No. 8-13	UL	E490803

Environmental Compliance

KEMET EMI filters are RoHS Compliant.



Typical Insertion Loss

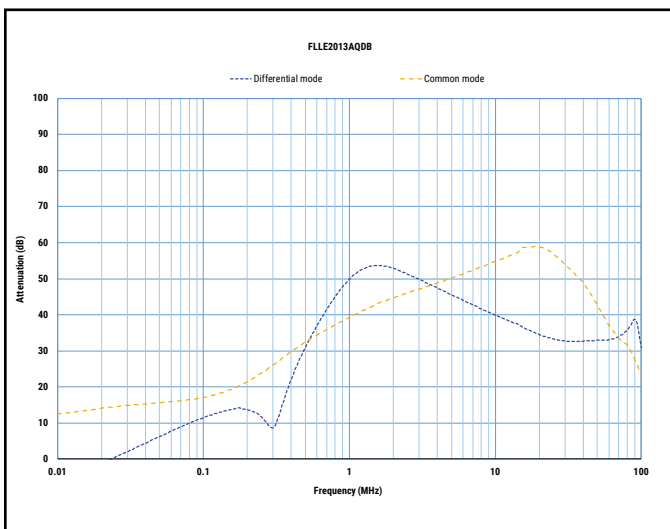
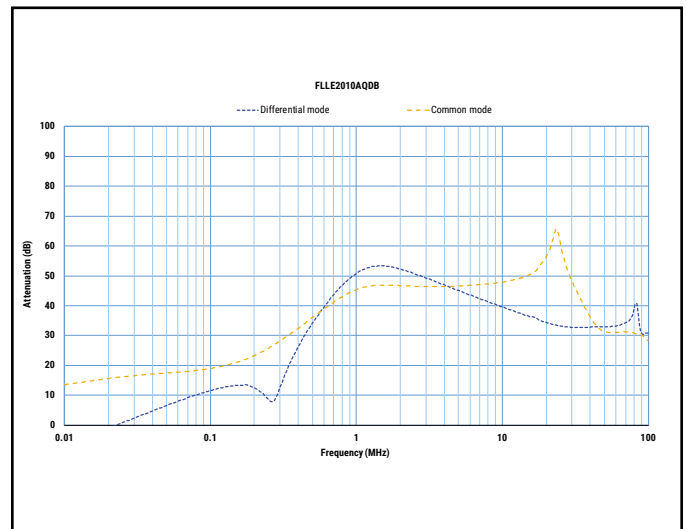
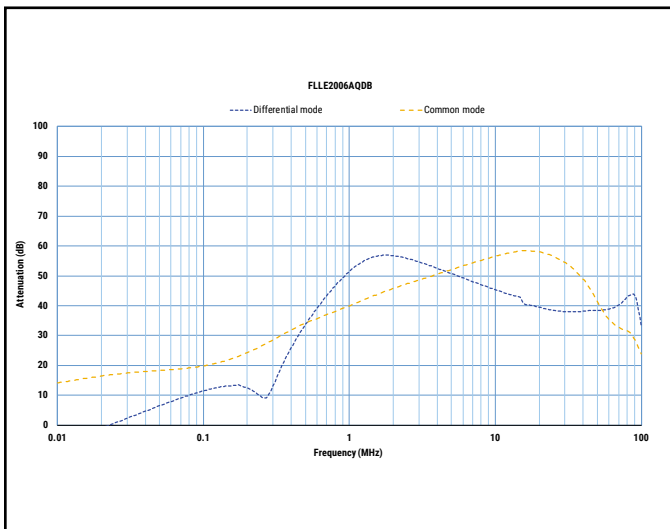
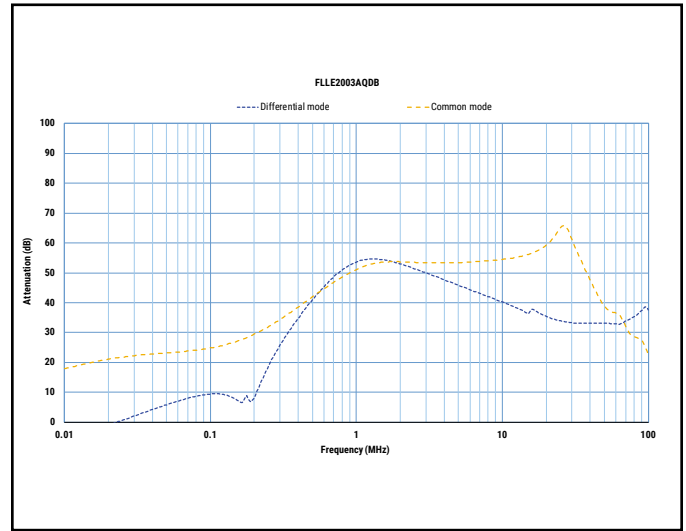
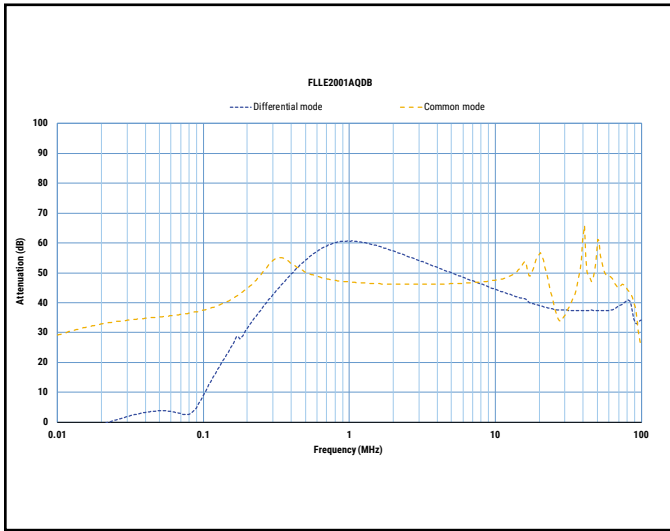

Typical Insertion Loss cont.

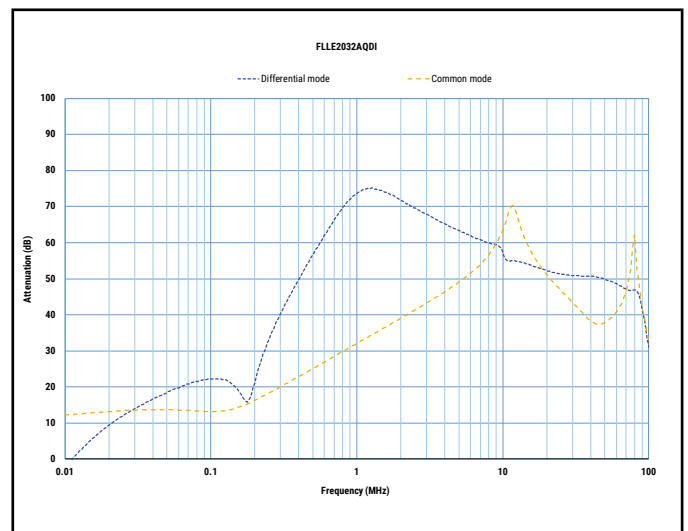
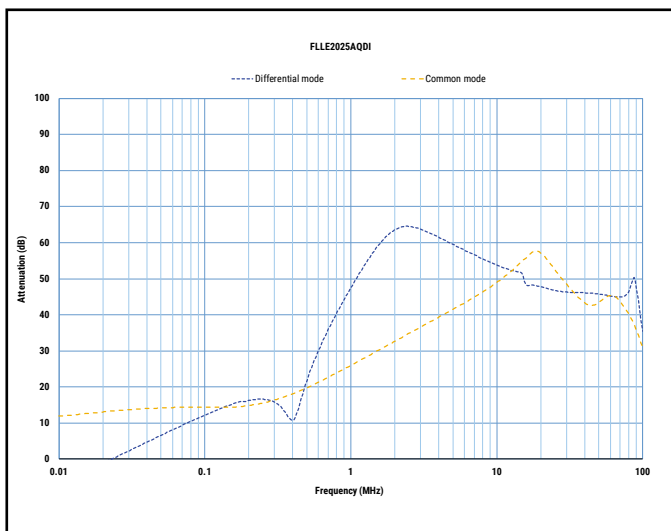
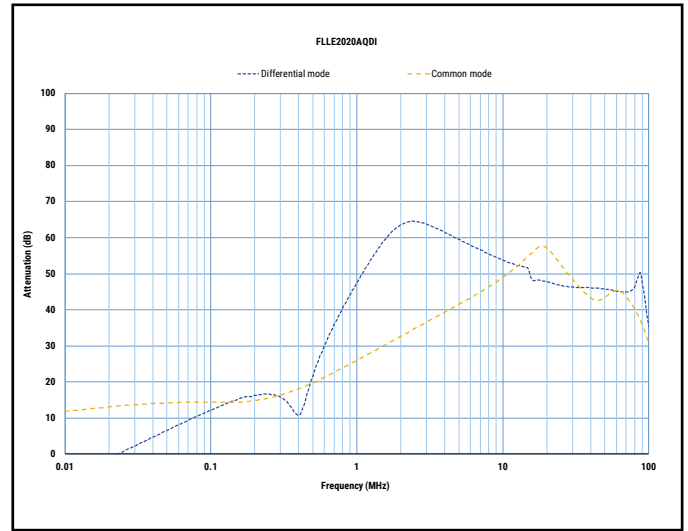
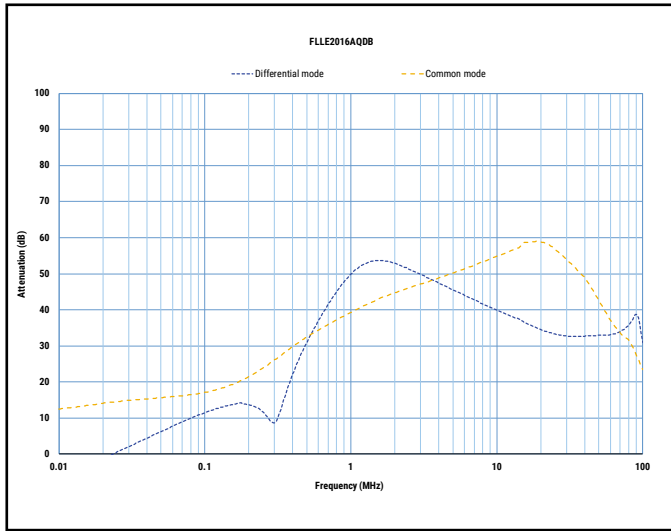

Mechanical Dimensions – Millimeters

1A, 3A, and 6A

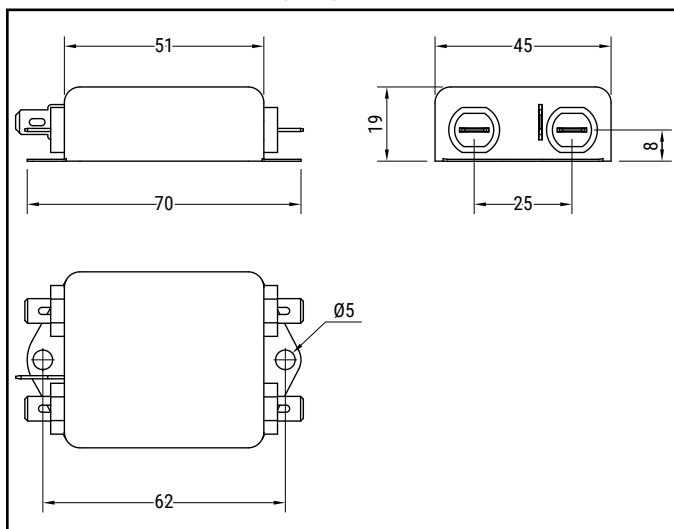

10A, 13A, and 16A

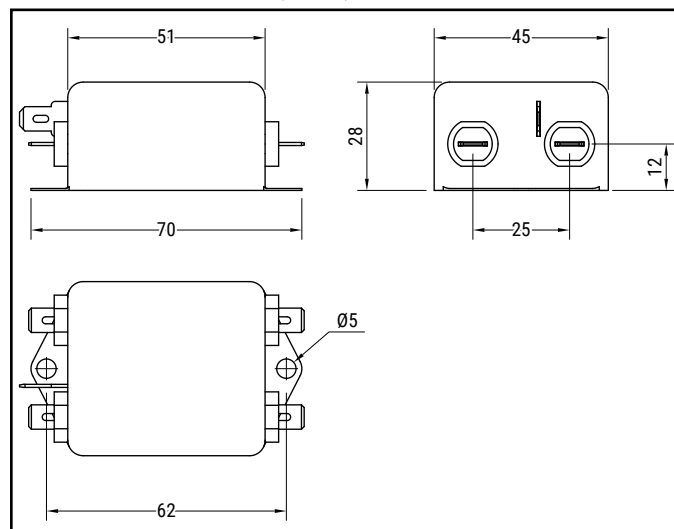

20A and 25A

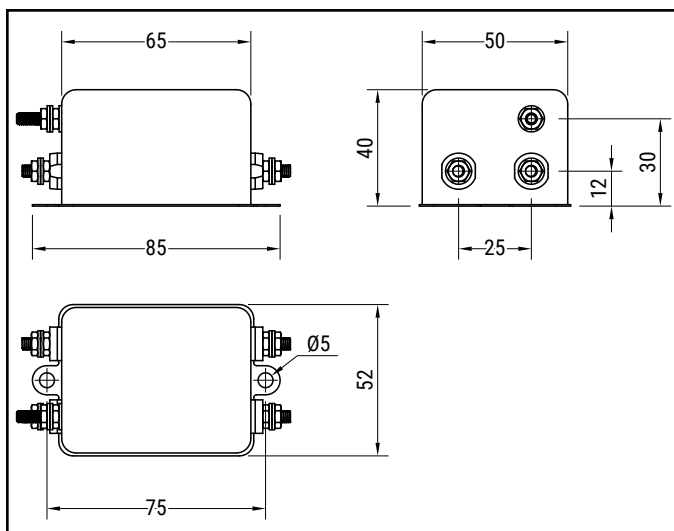

32A

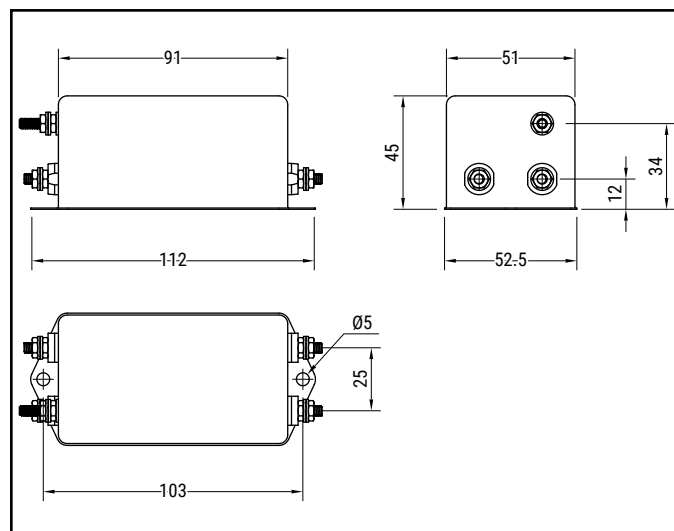

Part Number	L (mm)	W (mm)	H (mm)	Weight (g)	Fast-on Terminal	Threaded Terminal	Flexible Wire (mm ²)
FLLE2001AQ(1)(2)	51	45	19	95	6.3 x 0.8		0.75
FLLE2003AQ(1)(2)	51	45	19	95	6.3 x 0.8		0.75
FLLE2006AQ(1)(2)	51	45	19	95	6.3 x 0.8		1.5
FLLE2010AQ(1)(2)	51	45	28	130	6.3 x 0.8		1.5
FLLE2013AQ(1)(2)	51	45	28	140	6.3 x 0.8		1.5
FLLE2016AQ(1)(2)	51	45	28	140	6.3 x 0.8		2.5
FLLE2020AQ(1)(2)	65	50	40	290		M4 x 0.7	2.5
FLLE2025AQ(1)(2)	65	50	40	290		M4 x 0.7	2.5
FLLE2032AQ(1)(2)	91	51	45	415		M4 x 0.7	4

(1) D = Standard, M = Medical

(2) B = Fast-on (1-16A), I = Threaded (20-32A), D = Wire (1-32A)

KEMET Electronics Corporation Sales Offices

For a complete list of our global sales offices, please visit www.kemet.com/sales.

Disclaimer

All product specifications, statements, information and data (collectively, the "Information") in this datasheet are subject to change. The customer is responsible for checking and verifying the extent to which the Information contained in this publication is applicable to an order at the time the order is placed. All Information given herein is believed to be accurate and reliable, but it is presented without guarantee, warranty, or responsibility of any kind, expressed or implied.

Statements of suitability for certain applications are based on KEMET Electronics Corporation's ("KEMET") knowledge of typical operating conditions for such applications, but are not intended to constitute – and KEMET specifically disclaims – any warranty concerning suitability for a specific customer application or use. The Information is intended for use only by customers who have the requisite experience and capability to determine the correct products for their application. Any technical advice inferred from this Information or otherwise provided by KEMET with reference to the use of KEMET's products is given gratis, and KEMET assumes no obligation or liability for the advice given or results obtained.

Although KEMET designs and manufactures its products to the most stringent quality and safety standards, given the current state of the art, isolated component failures may still occur. Accordingly, customer applications which require a high degree of reliability or safety should employ suitable designs or other safeguards (such as installation of protective circuitry or redundancies) in order to ensure that the failure of an electrical component does not result in a risk of personal injury or property damage.

Although all product-related warnings, cautions and notes must be observed, the customer should not assume that all safety measures are indicated or that other measures may not be required.

KEMET is a registered trademark of KEMET Electronics Corporation.

X-ON Electronics

Largest Supplier of Electrical and Electronic Components

Click to view similar products for [Power Line Filters](#) category:

Click to view products by [Kemet](#) manufacturer:

Other Similar products are found below :

[6609019-3](#) [6609026-5](#) [6609030-6](#) [6609973-2](#) [D30A](#) [7-1609090-5](#) [F2810](#) [F4456A](#) [F7382Z](#) [F7863Z](#) [FAHAV3100ZC000](#) [806276](#) [FN2020B-1-06](#) [FN2080B-10-06](#) [FN2410H-32-33](#) [FP144](#) [FS4153-20-06](#) [FS4353-500-99](#) [12-MMB-030-11-D](#) [DB4-393](#) [15811T200](#) [20B1](#) [LC630](#) [2B1](#) [1609080-2](#) [1609993-8](#) [1-6609070-1](#) [F1100AA02](#) [F1150CC10](#) [F1500CA10](#) [F1500CA15](#) [F4041Z](#) [F7585E](#) [1B1](#) [FN2070A-16-06](#) [FN2090A-20-06](#) [FN2090B-12-06](#) [FN2090Z-1-06](#) [FN2410H-25-33](#) [FN2410H-60-34](#) [FN2410H-8-44](#) [FN2412H-8-44](#) [FN323B-6-01](#) [FN3258H-130-35](#) [FN610R-3-06](#) [20EHQ7](#) [20EHZ7](#) [20K1](#) [30B6](#) [3K1](#)