

Overview

General purpose, single phase filter series with high/very high attenuation. Chassis mount for fast mounting, metal case filled with self-extinguishing resin. Fast-on or screw terminals available and options with flexible wire connections. Medical versions available without y-capacitors for no leakage current.

**RoHS
Compliant**

Technical specifications

Item	Parameters/ Characteristics
Rated Voltage	300 VAC/VDC
Rated Frequency	50 - 60 Hz
Rated Current	1 - 32 A
Rated Temperature	40°C
Temperature range	-25°C to 100°C
Climate Category	25/ 100/21
Voltage Test	P -> N 1300 VDC P/N -> E 2250 VDC

Typical electrical schematics

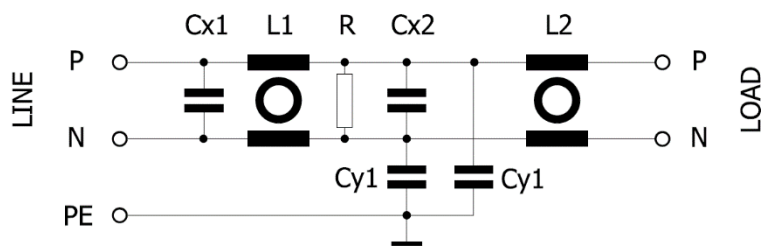

Components

Part Number	Rated Current @ 40°C (A)	Leakage Current *) (mA)	C _{x1} (μF)	R (MΩ)	L1 (mH)	C _{y1} (nF)	C _{x2} (μF)	L2 (mH)
FLLE2001AS(1)(2)	1	0.37	0.33	0.68	22	4.7	0.33	22
FLLE2003AS(1)(2)	3	0.37	0.47	0.47	14	4.7	0.47	14
FLLE2006AS(1)(2)	6	0.37	1	0.22	8	4.7	1	8
FLLE2010AS(1)(2)	10	0.37	1	0.22	5	4.7	1	5
FLLE2013AS(1)(2)	13	0.37	1	0.22	4	4.7	1	4
FLLE2016AS(1)(2)	16	0.37	1	0.22	4	4.7	1	4
FLLE2020AS(1)(2)	20	0.37	2.2	0.15	2	4.7	2.2	2
FLLE2025AS(1)(2)	25	0.37	2.2	0.15	2	4.7	2.2	2
FLLE2032AS(1)(2)	32	0.37	2.2	0.15	1.3	4.7	2.2	1.3

(1) D= Standard, M = Medical

(2) B = Fast-on (1-16A), I = Threaded (20-32A), D = Wire (1-32A)

*) Leakage current @250 VAC/ 50 Hz acc. to IEC60939-3. Medical version without C_y-capacitors, no leakage current.

Approvals (pending)

Standard

IEC/EN 60939-3
 ANSI/UL 60939-3-2016

Certification Body

UL-Demko
 UL

File

Pending
 Pending



Typical insertion loss

FLLE2001ASDB

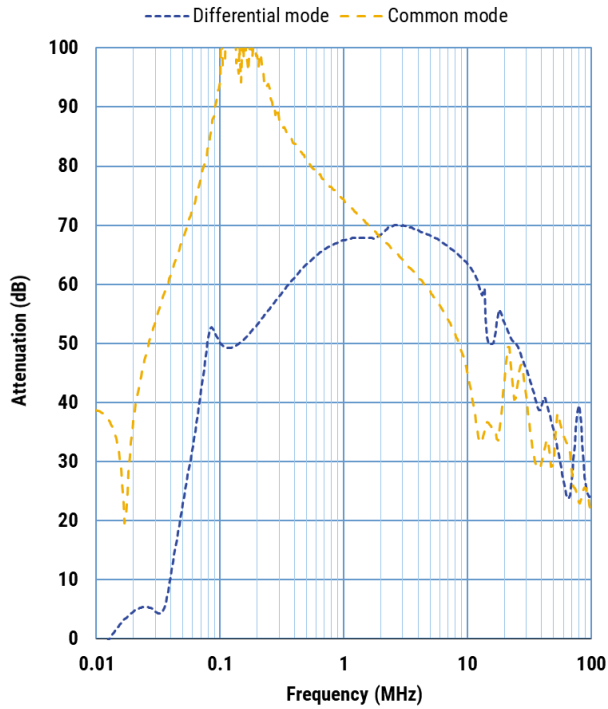

FLLE2003ASDB

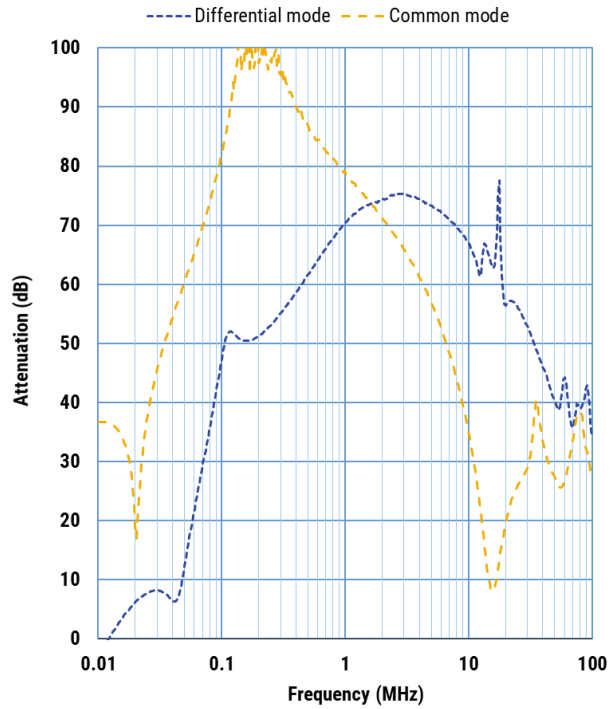

FLLE2006ASDB

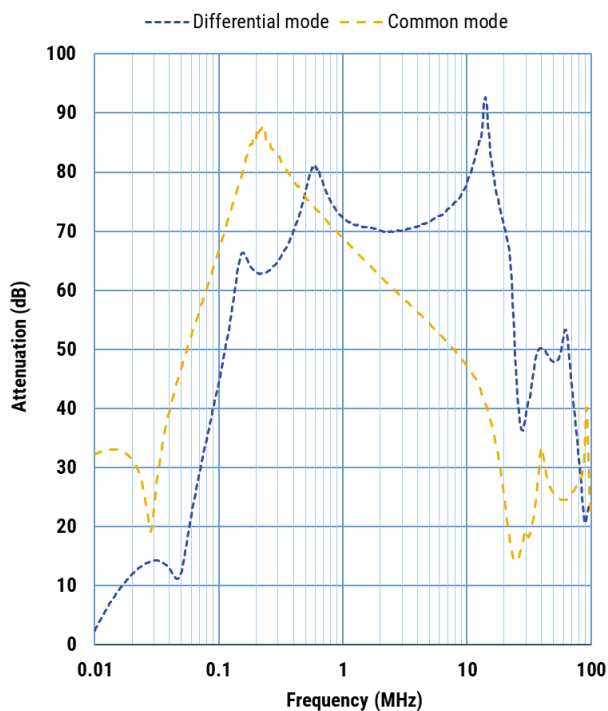

FLLE2010ASDB

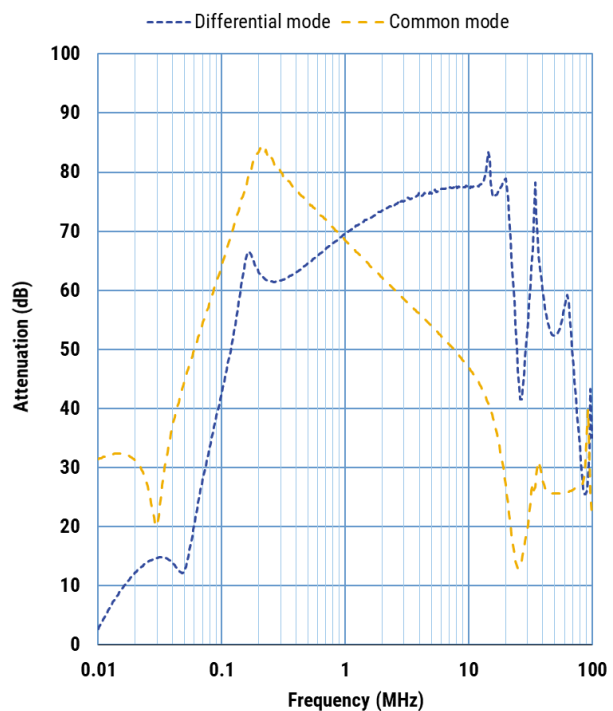

FLLE2013ASDB

FLLE2016ASDB

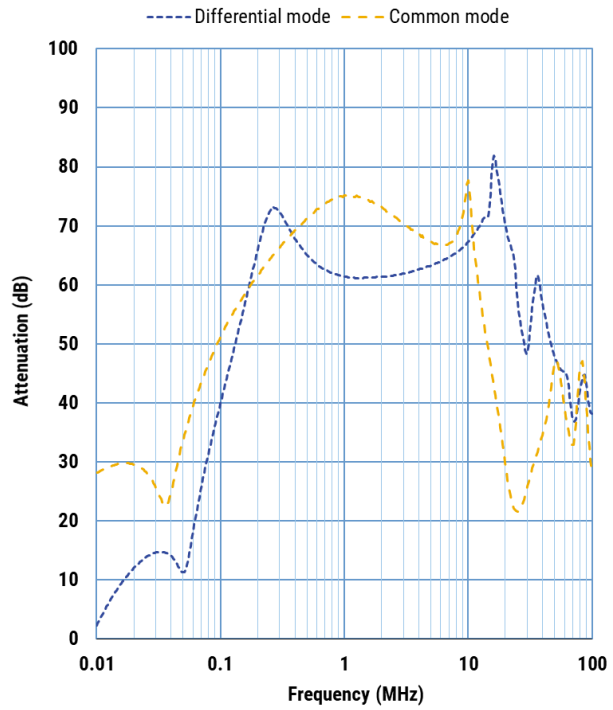
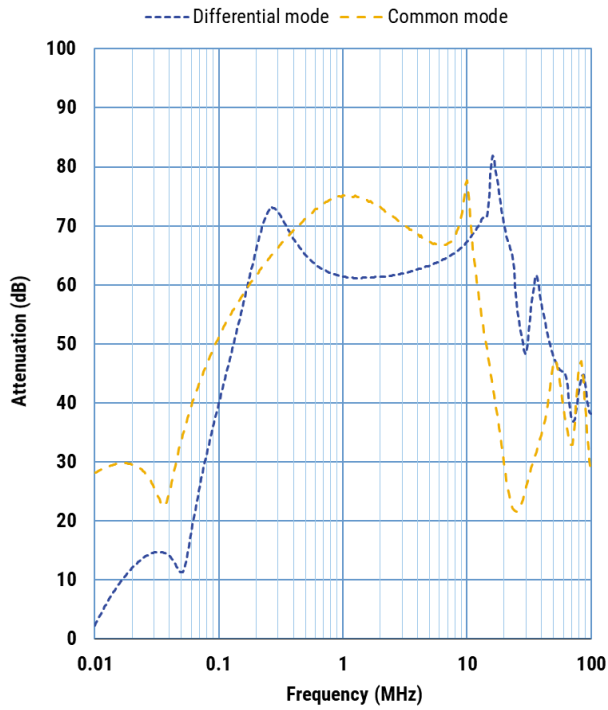

FLLE2020ASDI

FLLE2025ASDI

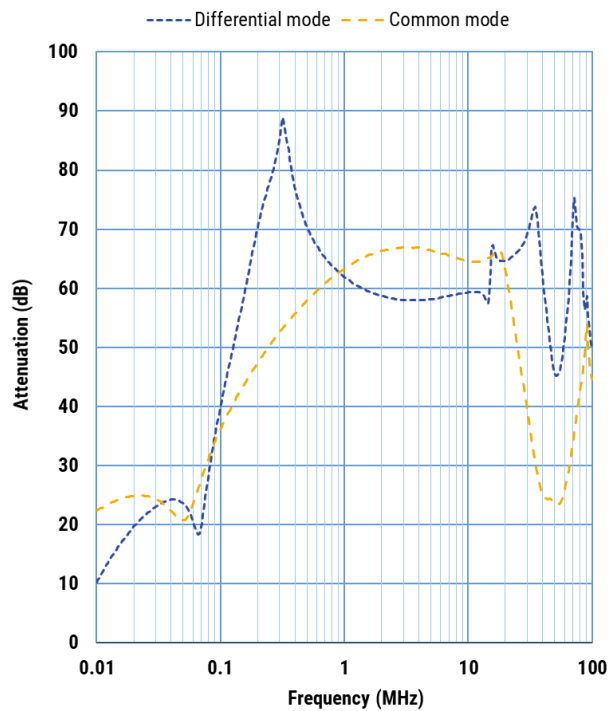
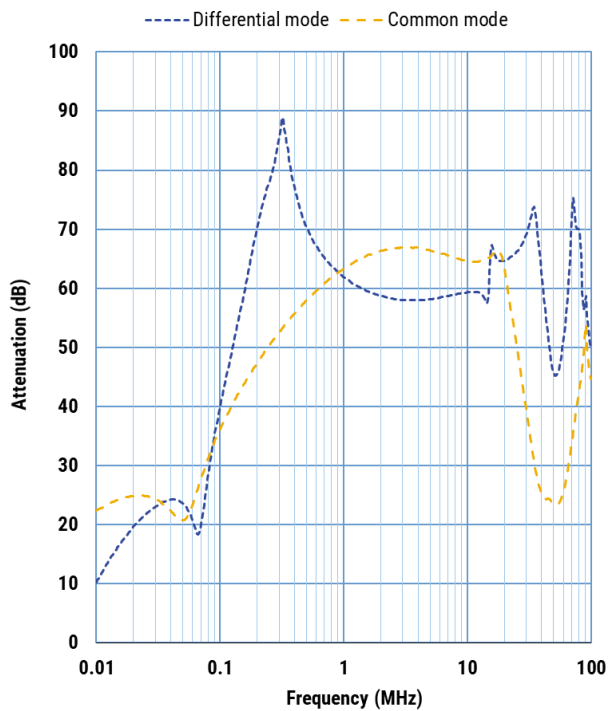

FLLE2032ASDI

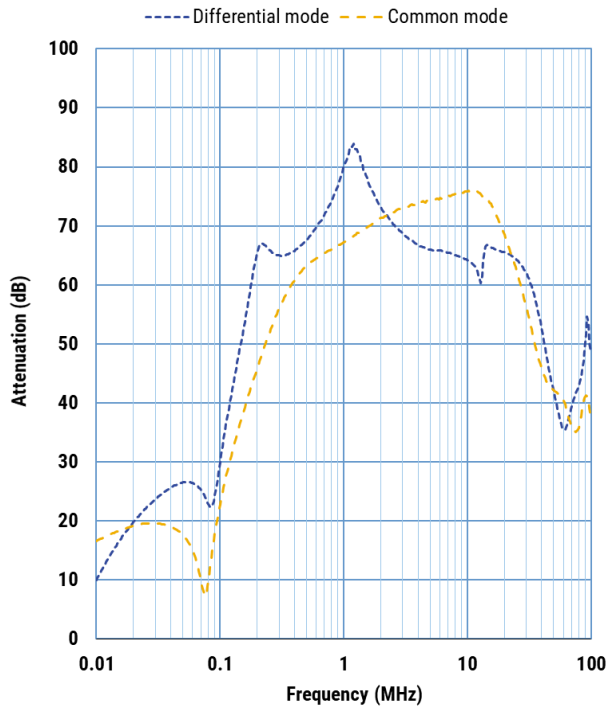

Mechanical dimensions

Part Number	L (mm)	W (mm)	H (mm)	Weight (g)	Fast-on Terminal	Threaded Terminal	Flexible Wire (mm ²)
FLLE2001AS(1)(2)	51	45	28	130	6.3 x 0.8		0.75
FLLE2003AS(1)(2)	65	50	40	280	6.3 x 0.8		0.75
FLLE2006AS(1)(2)	91	51	45	410	6.3 x 0.8		1.5
FLLE2010AS(1)(2)	91	51	45	410	6.3 x 0.8		1.5
FLLE2013AS(1)(2)	130.5	56.5	48.5	690	6.3 x 0.8		1.5
FLLE2016AS(1)(2)	130.5	56.5	48.5	690	6.3 x 0.8		2.5
FLLE2020AS(1)(2)	130.5	56.5	48.5	720		M4 x 0.7	2.5
FLLE2025AS(1)(2)	130.5	56.5	48.5	720		M4 x 0.7	2.5
FLLE2032AS(1)(2)	130.5	56.5	48.5	800		M4 x 0.7	4

(1) D = Standard, M = Medical

(2) B = Fast-on, I = Threaded, D = Wire (Length = 140±5 mm)

1A

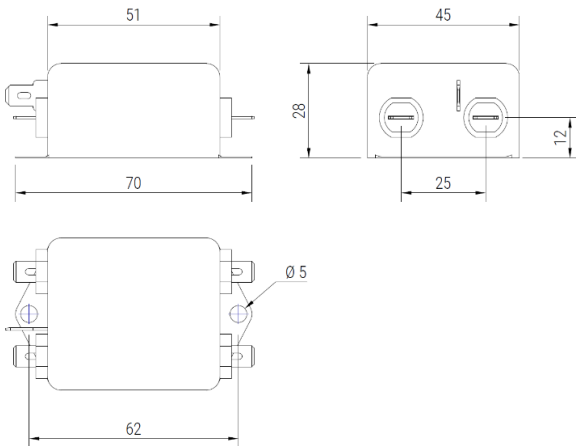

3A

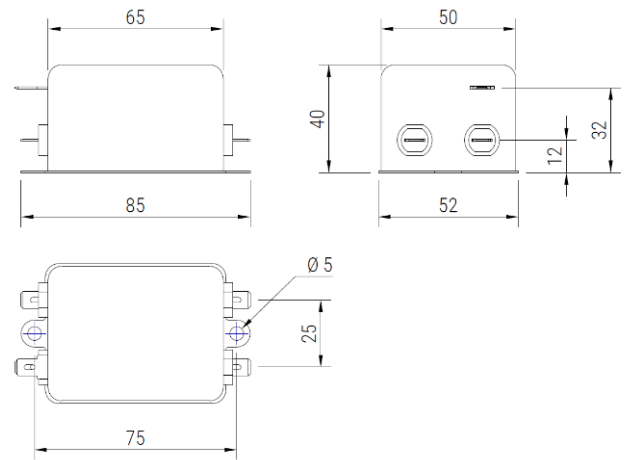

6A and 10A

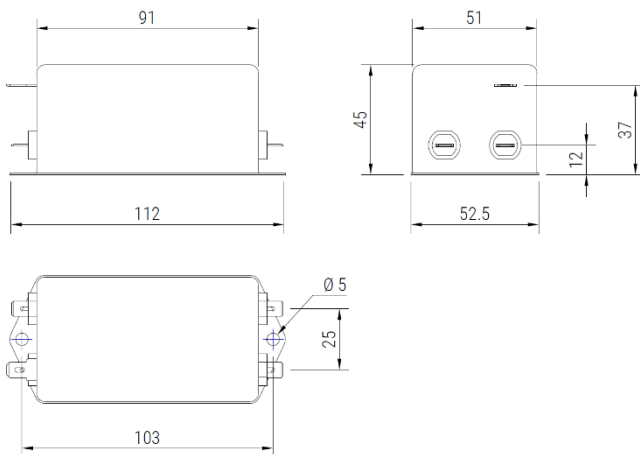

13A and 16A

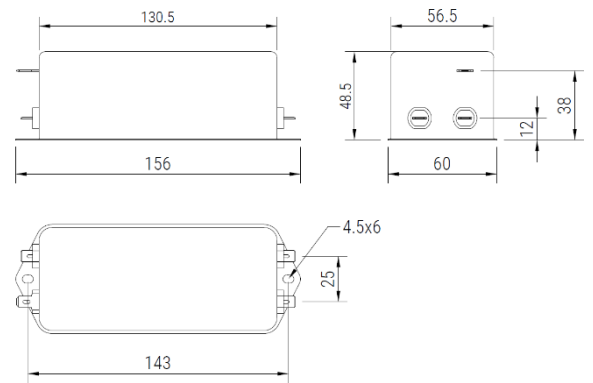

20A, 25A and 32A

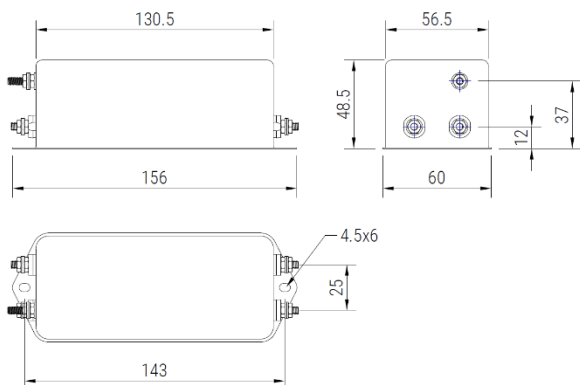

Legal disclaimer notice

All product specifications, statements, information and data (collectively, the "information") are subject to change without notice.

All information given herein is believed to be accurate and reliable, but is presented without guarantee, warranty, or responsibility of any kind, expressed or implied.

Statements of suitability for certain applications are based on our knowledge of typical operating conditions for such applications, but are not intended to constitute – and we specifically disclaim – any warranty concerning suitability for a specific customer application or use.

This information is intended for use only by customers who have the requisite experience and capability to determine the correct products for their applications. Any technical advice inferred from this information or otherwise provided by us with reference to the use of our

products is given gratis, and we assume no obligation or liability for the advice given or results obtained.

Although we design and manufacture our products to the most stringent quality and safety standards, given the current state of the art, isolated component failures may still occur. Accordingly, customer applications which require a high degree of reliability or safety should employ suitable designs or other safeguards (such as installation of protective circuitry or redundancies) in order to ensure that failure of an electrical component does not result in a risk of personal injury or property damage.

Although all product-related warnings, cautions and notes must be observed, the customer should not assume that all safety measures are indicated or that other measures may not be required.

X-ON Electronics

Largest Supplier of Electrical and Electronic Components

Click to view similar products for [Power Line Filters](#) category:

Click to view products by [Kemet](#) manufacturer:

Other Similar products are found below :

[6609026-5](#) [6609030-6](#) [6609973-2](#) [D30A](#) [F2810](#) [F7140A](#) [F7382Z](#) [F7863Z](#) [FAHAV3100ZC000](#) [806276](#) [FN2080B-10-06](#) [FN2410H-32-33](#)
[FN2410H-80-34](#) [FP144](#) [FS4153-20-06](#) [12-MMB-030-11-D](#) [DB4-393](#) [15811T200](#) [2B1](#) [1609080-2](#) [F1100AA02](#) [F1150CC10](#) [F1500CA10](#)
[F1500CA15](#) [1B1](#) [FN2020B-3-06](#) [FN2070A-16-06](#) [FN2090A-20-06](#) [FN2090Z-1-06](#) [FN2410H-25-33](#) [FN2410H-8-44](#) [FN2412H-25-33](#)
[FN2412H-8-44](#) [FN323B-6-01](#) [FN3258H-130-35](#) [20EHQ7](#) [20K1](#) [30B6](#) [01MK4](#) [03DRDW3](#) [03MK2](#) [03DEEG3BM](#) [100BCF6](#) [10K1](#) [RWK-](#)
[305-4-KL](#) [STFV025-24L](#) [609-025](#) [7-6609082-0](#) [3W1A](#) [6609041-1](#)