

Overview

The KEMET GT metal box filters cover single-phase requirements with a wide variety of characteristics. These filters are optimized for conduction noise. Their input/output terminals are screw type or Faston® type.

Applications

- Industrial equipment
- Electronic equipment
- Vending machines

Benefits

- Single-phase 250 VAC
- Current range from 3 to 20 A
- Operating temperature range from -25°C to +55°C
- UL, CSA, or TÜV approved versions available
- RoHS compliant



Part Number System

GT-	2	20	01V
Series	Phase	Rated Current (A)	Specification
GT	2 = Single-phase	0x = 0x A xx = xx A	0 = Standard, no approvals 01 = High performance at low frequency, single common choke, Faston® terminal 02 = High performance at low frequency, double common choke, Faston® terminal 01V = High performance at low frequency, single common choke, screw terminal J = Faston® terminal with DC input support R = High performance to pulse noise U = UL, CSA, and/or TÜV approved Note: Faston® is a registered trademark of Tyco Electronics AMP

Dimensions – Millimeters

GT-205U, GT-2050R

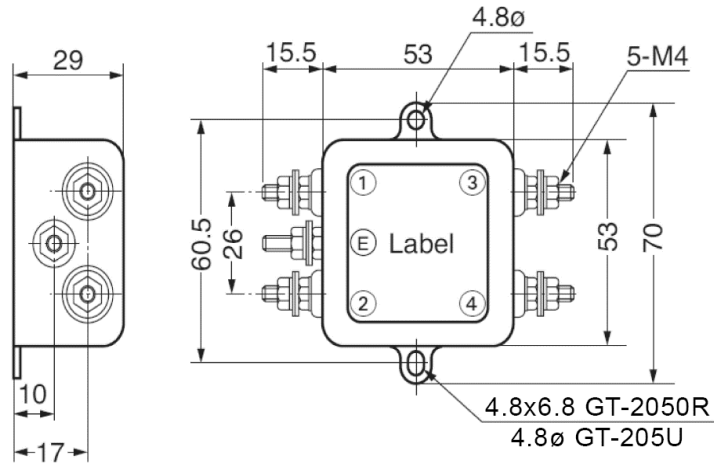

Recommended torque (N-m) maximum

- Line terminal (M4: 0.78)
- Earth terminal (M4: 1.18)

GT-2150R, GT-2100, GT-2150, GT-2200, GT-210U, GT-215U, GT-220U

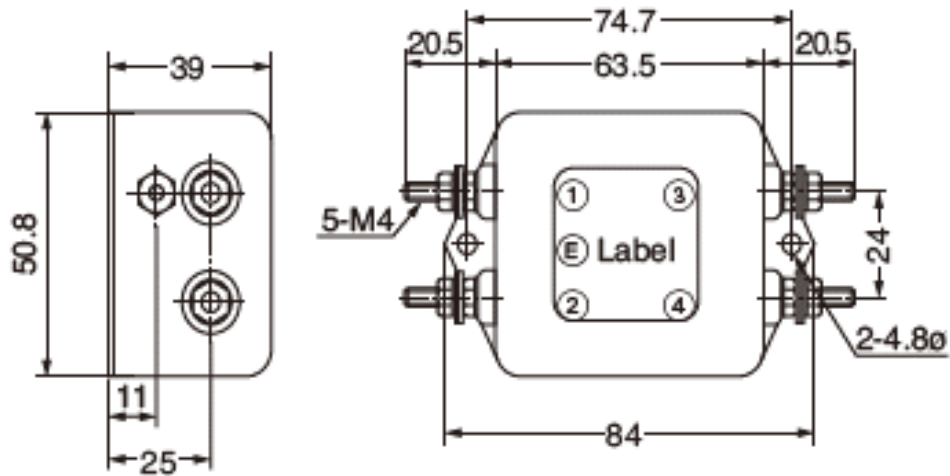

Recommended torque (N-m) maximum

- Line terminal (M4: 0.78)
- Earth terminal (M4: 1.18)

Dimensions – Millimeters cont.

GT-205J

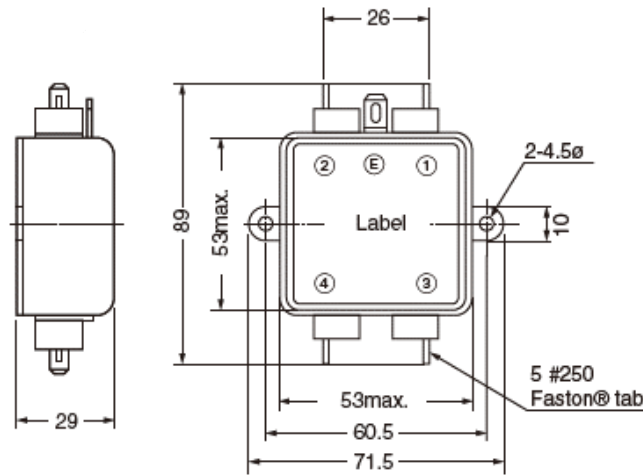

Faston® is a registered trademark of Tyco Electronics AMP.

GT-210J, GT-215J

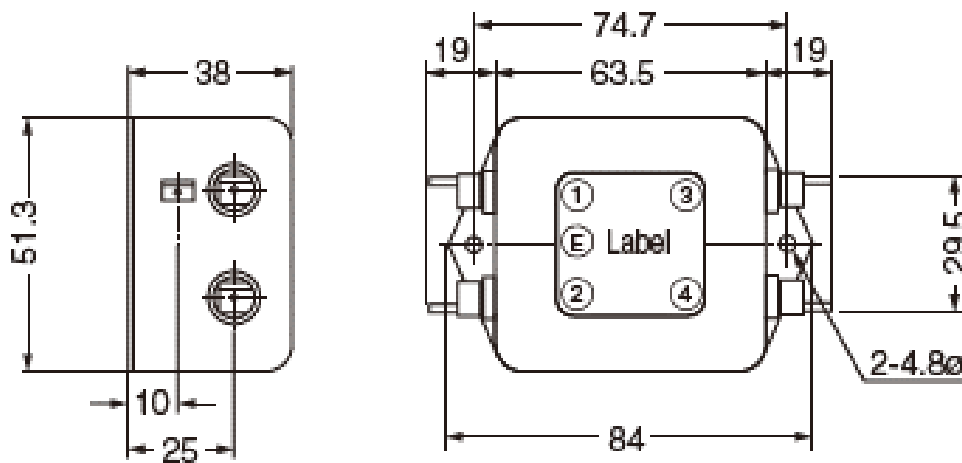

Dimensions – Millimeters cont.

GT-20301, GT-21001, GT-20302

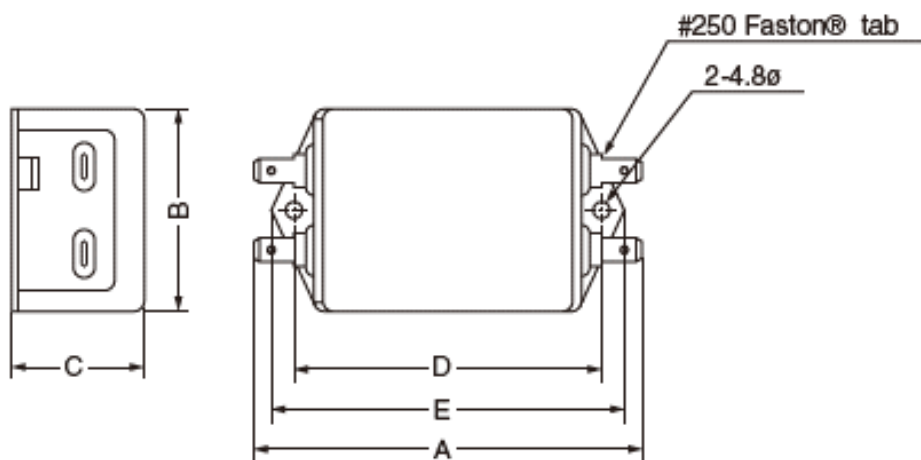

Faston® is a registered trademark of Tyco Electronics AMP.

Part Number	A	B	C	D	E
GT-20301	93.0	53.0	30.0	74.7	85.0
GT-21001	105.5	57.5	44.5	87.0	96.5
GT-20302	93.0	53.0	46.0	74.7	84.3

GT-20501V, GT-21001V, GT-22001V

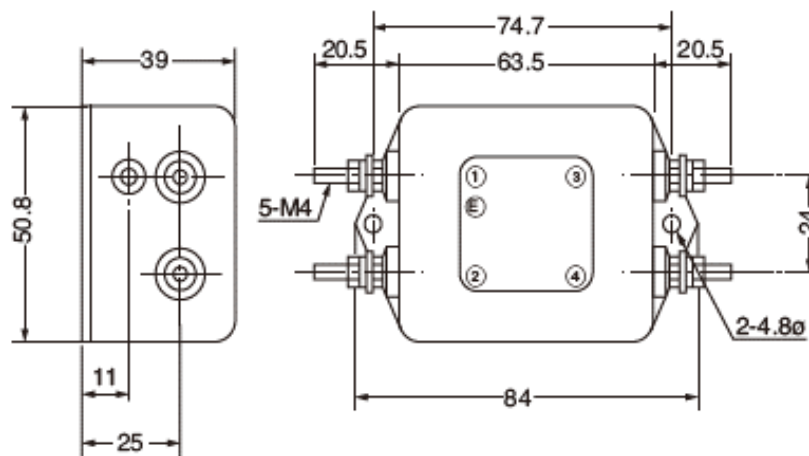

Recommended torque (N-m) maximum

- Line terminal (M4: 0.78)
- Earth terminal (M4: 1.18)

Environmental Compliance

KEMET GT EMI-RFI Filters comply with EU RoHS Directive 2011/65/EU and (EU) 2015/863. Products that fall under the exemptions listed in below table are also included.



Part Number	RoHS Compliant	RoHS Exemption Code
GT-205U	Yes	6(c) and 7(c)-I
GT-2050R	Yes	6(c)
GT-2150R	Yes	6(c)
GT-2100	Yes	6(c)
GT-2150	Yes	6(c)
GT-2200	Yes	6(c)
GT-210U	Yes	6(c) and 7(c)-I
GT-215U	Yes	6(c) and 7(c)-I
GT-220U	Yes	6(c) and 7(c)-I
GT-205J	Yes	7(c)-I
GT-210J	Yes	7(c)-I
GT-215J	Yes	7(c)-I
GT-20301	Yes	6(c) and 7(c)-I
GT-21001	Yes	6(c) and 7(c)-I
GT-20302	Yes	6(c) and 7(c)-I
GT-20501V	Yes	6(c) and 7(c)-I
GT-21001V	Yes	6(c) and 7(c)-I
GT-22001V	Yes	6(c) and 7(c)-I

Code	Exemption
6(c)	Copper alloy containing up to 4% lead by weight
7(c)-I	Electrical and electronic components containing lead in a glass or ceramic other than dielectric ceramic in capacitors, e.g. piezoelectronic devices, or in a glass or ceramic matrix compound

Approvals

Certification Body	File Number	Part Number
UL	E59551	GT-205U, GT-210U, GT-215U, GT-220U, GT-205J, GT-210J, GT-215J, GT-20301, GT-21001, GT-20302, GT-21001V and GT-22001V
CAS	LR50413	GT-205U, GT-210U, GT-205J, GT-210J, GT-215J, GT-20301, GT-21001, GT-20302 and GT-21001V
TÜV Rheinland Japan Ltd.	R50004761	GT-21001V
	R50007113	GT-22001V
	R50014761	GT-205J, GT-210J and GT-215J
	R50015833	GT-205U, GT-210U, GT-20301, GT-21001 and GT-20302
	R9651191	GT-220U

Performance Characteristics

Item	Performance Characteristics
Rated Voltage	250 V
Rated Current Range	3 – 20 A
Withstanding Voltage	1,500 VAC (1 minute, line to ground) except GT-2**01V: 2,000 VAC (1 minute, line to ground)
Insulation Resistance	300 MΩ minimum at 500 VDC (1 minute, line to ground)
Leakage Current Range	0.5 – 1.0 mA maximum at 250 V/60 Hz
Input/Output Terminal Type	Screw and Faston®
Operating Temperature Range	-25°C to +55°C (not including self temperature rise)

Table 1 – Ratings & Part Number Reference

Part Number	Phase	Rated Voltage AC (V)	Rated Current AC (A)	DC Available	Leakage Current at 250 V/60 Hz (mA) Maximum	Temperature Rise (K) Maximum	Operating Temperature Range	Terminal Type	Approval	Weight (g)
GT-205U	Single-phase	250	5	Yes	0.5	35	-25°C to +55°C	Screw	UL, CSA and TÜV	170
GT-2050R	Single-phase	250	5	Yes	0.5	35	-25°C to +55°C	Screw		160
GT-2150R	Single-phase	250	15	Yes	0.5	35	-25°C to +55°C	Screw		280
GT-2100	Single-phase	250	10	Yes	0.5	35	-25°C to +55°C	Screw		260
GT-2150	Single-phase	250	15	Yes	0.5	35	-25°C to +55°C	Screw		270
GT-2200	Single-phase	250	20	Yes	0.5	35	-25°C to +55°C	Screw		270
GT-210U	Single-phase	250	10	Yes	0.5	35	-25°C to +55°C	Screw	UL, CSA and TÜV	260
GT-215U	Single-phase	250	15	Yes	0.5	35	-25°C to +55°C	Screw	UL	270
GT-220U	Single-phase	250	20	Yes	0.5	35	-25°C to +55°C	Screw	UL and TÜV	270
GT-205J	Single-phase	250	5	Yes	0.5	35	-25°C to +55°C	Faston	UL, CSA and TÜV	135
GT-210J	Single-phase	250	10	Yes	0.5	35	-25°C to +55°C	Faston	UL, CSA and TÜV	240
GT-215J	Single-phase	250	15	Yes	0.5	35	-25°C to +55°C	Faston	UL, CSA and TÜV	255
GT-20301	Single-phase	250	3	No	1.0	30	-25°C to +55°C	Faston	UL, CSA and TÜV	160
GT-21001	Single-phase	250	10	No	1.0	30	-25°C to +55°C	Faston	UL, CSA and TÜV	300
GT-20302	Single-phase	250	3	No	1.0	30	-25°C to +55°C	Faston	UL, CSA and TÜV	215
GT-20501V	Single-phase	250	5	No	0.5	35	-25°C to +55°C	Screw		220
GT-21001V	Single-phase	250	10	No	0.5	35	-25°C to +55°C	Screw	UL, CSA and TÜV	280
GT-22001V	Single-phase	250	20	No	0.5	35	-25°C to +55°C	Screw	UL and TÜV	285

Circuit Diagram

GT-2**0, GT-2**0R

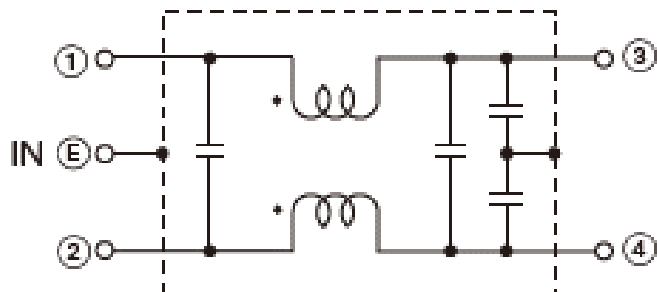

GT-2**U, GT-2**01V

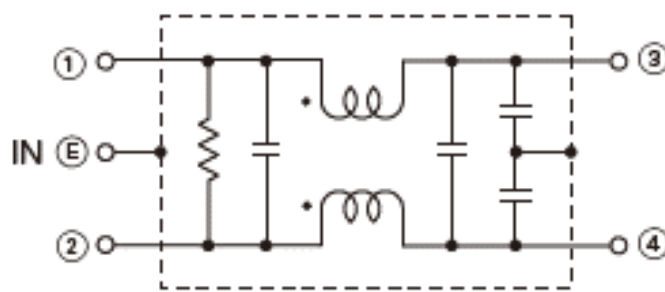

GT-2**J, GT-2**01

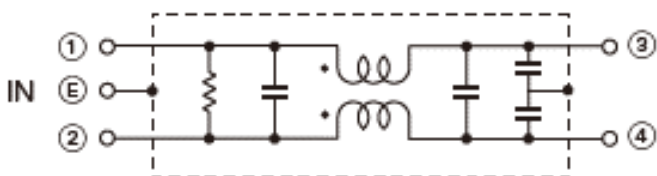

GT-2**02

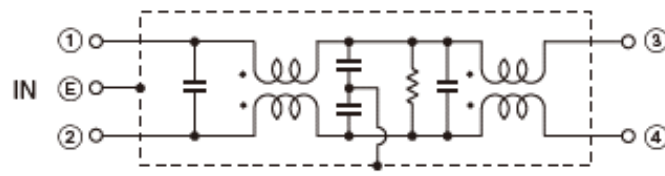

Measuring Circuit - Common Mode

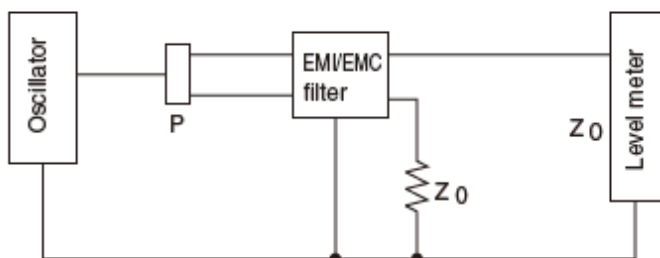

P: Power divider $Z_0: 50\Omega$

Measuring Circuit - Normal Mode

(Only for GT-2**01V, GT-2**01, GT-2**02)

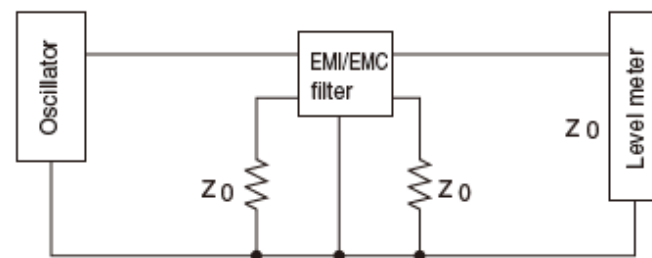

$Z_0: 50\Omega$

Pulse Attenuation Characteristics

Pulse Attenuation Example

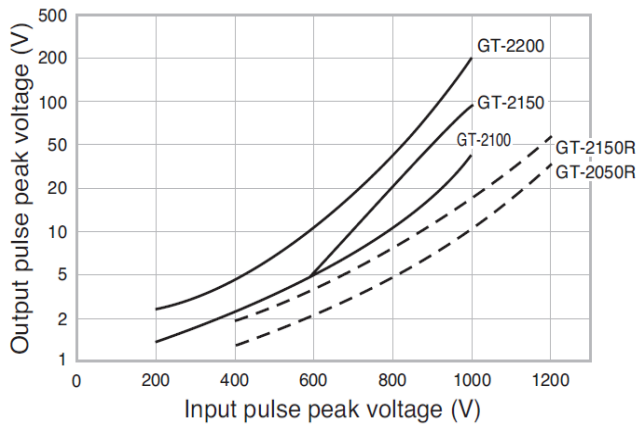

Pulse Attenuation Example

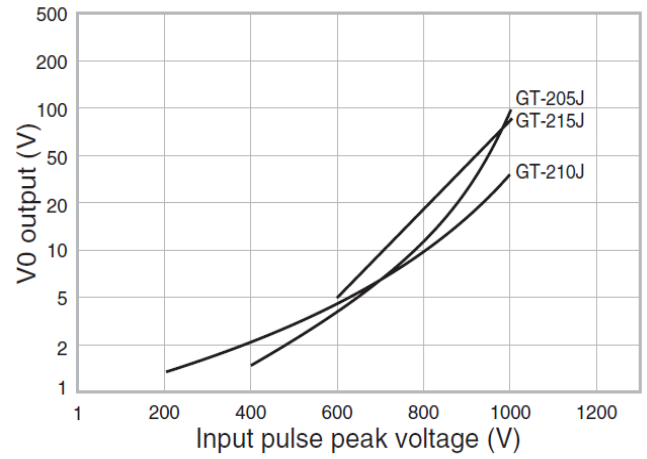

Pulse Characteristic Measuring Circuit

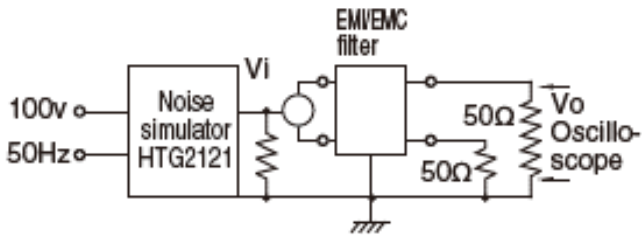

Attenuation (Static Characteristics)

GT-205U

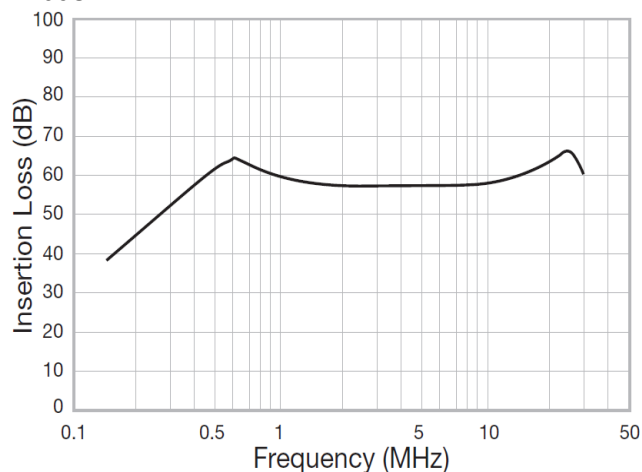

GT-2050R

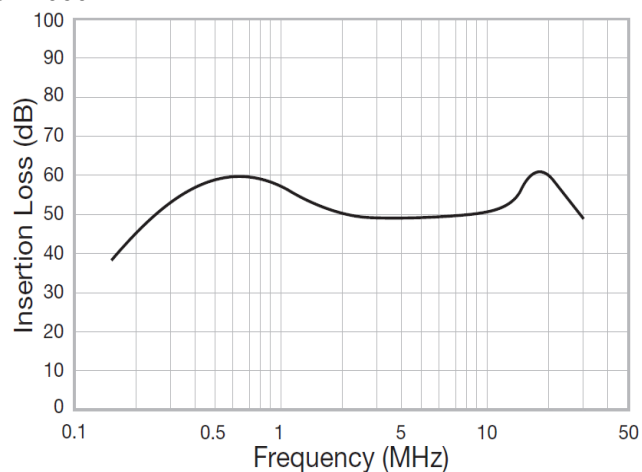

GT-2150R

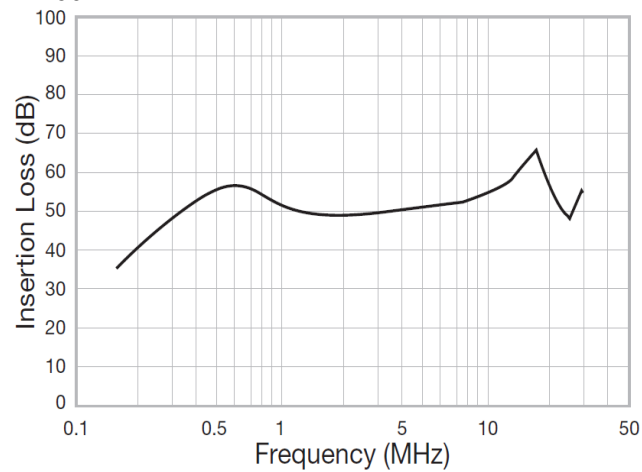

GT-2100, GT-210U

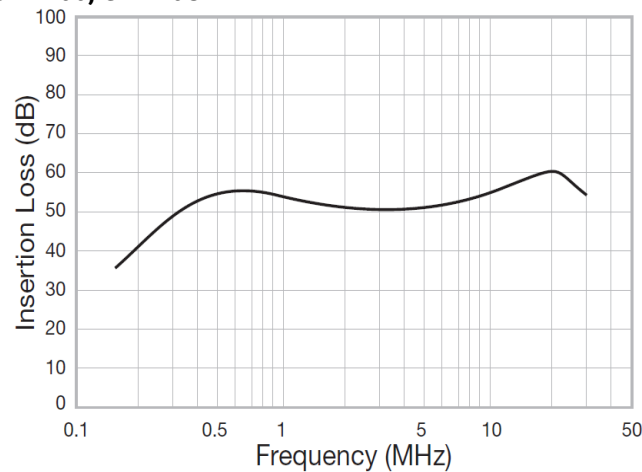

GT-2150, GT-215U

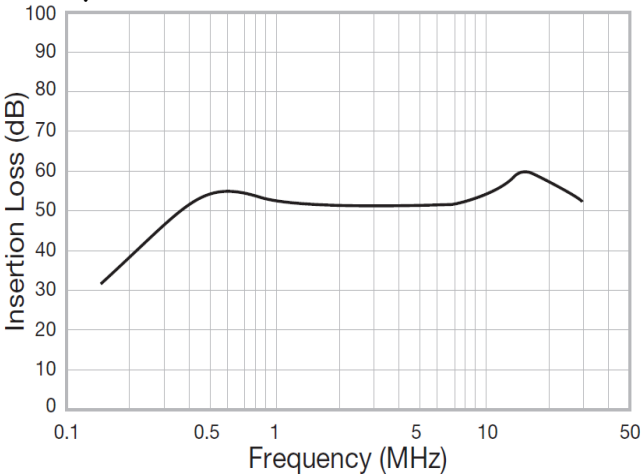

GT-2200, GT-220U

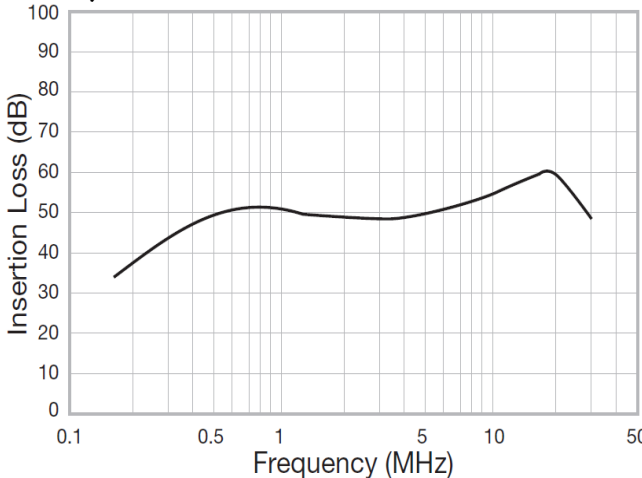

Attenuation (Static Characteristics) cont.

GT-205J

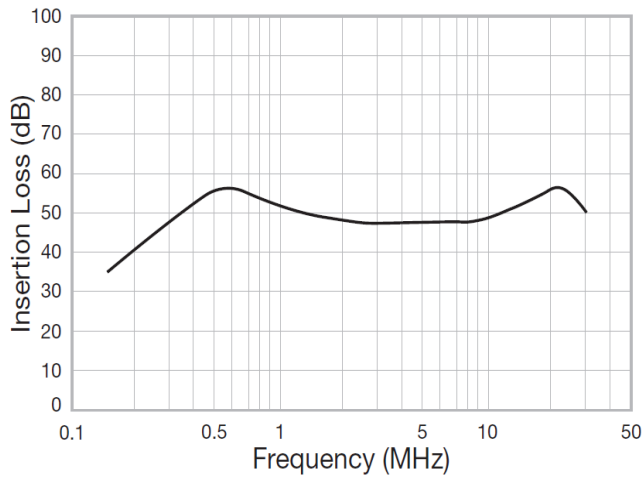

GT-210J

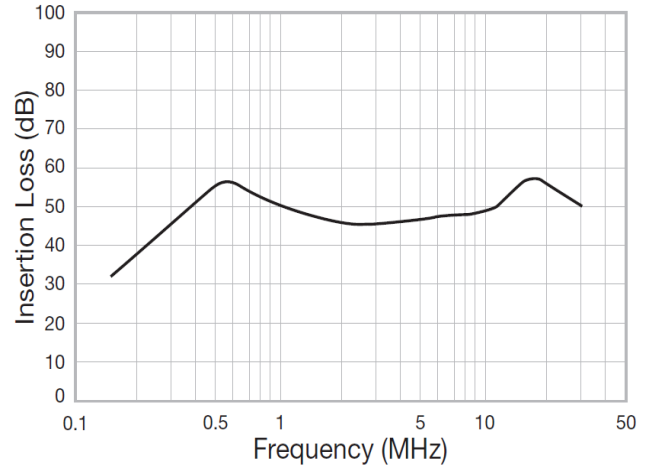

GT-215J

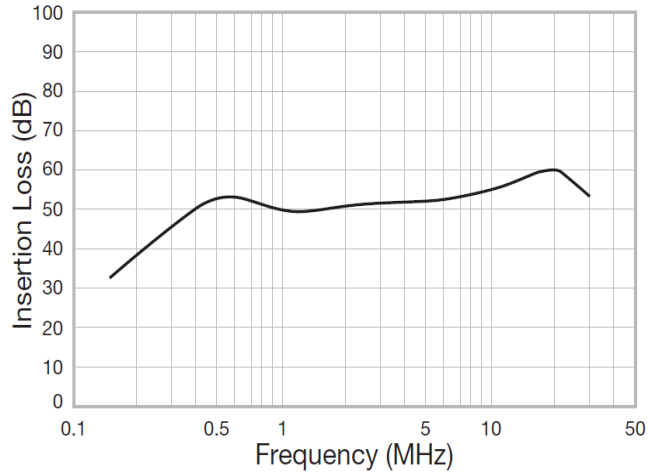

GT-20301, GT-21001

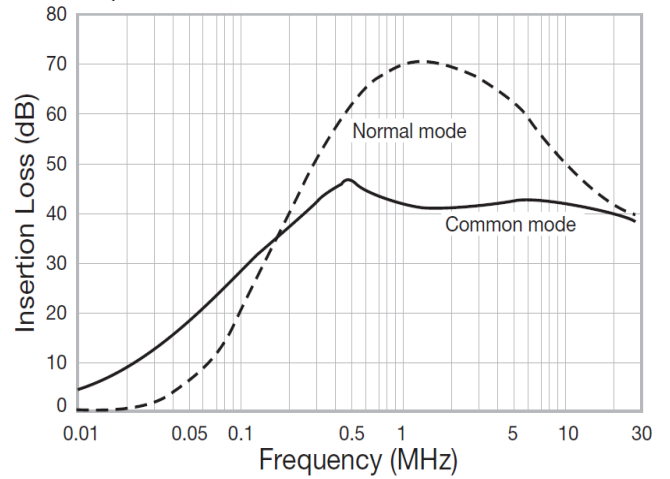

GT-20302

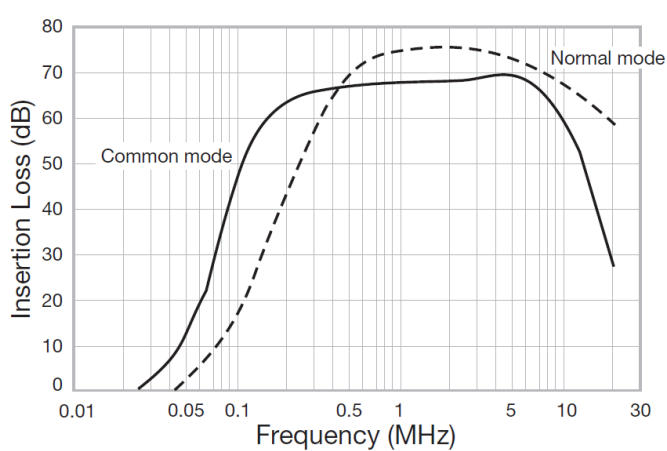

GT-20501V

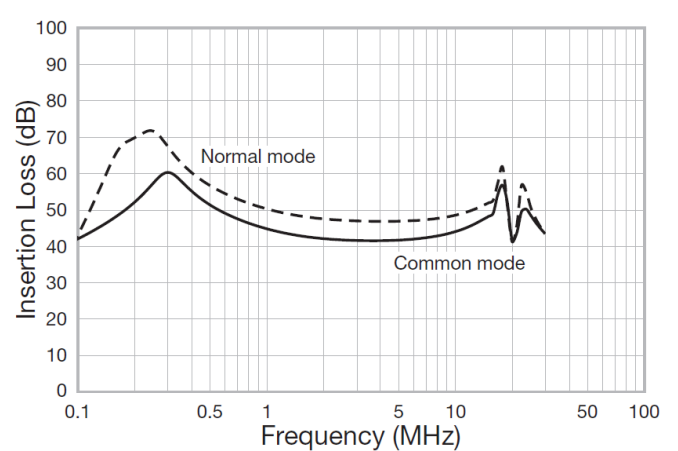

Attenuation (Static Characteristics) cont.

GT-21001V

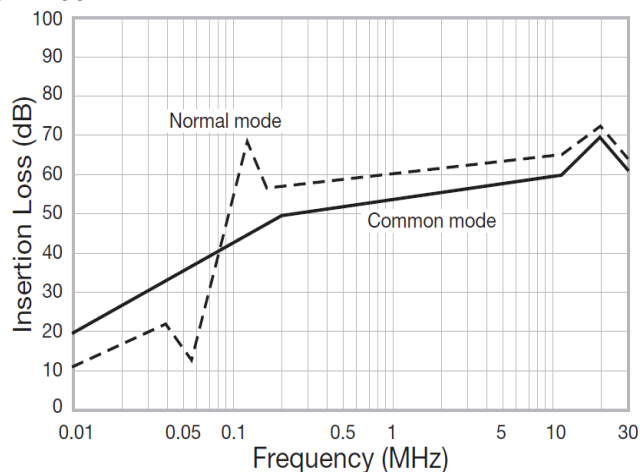

GT-22001V

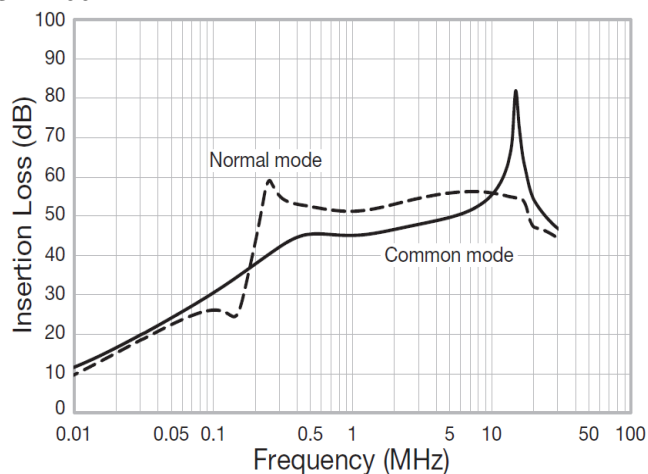

Packaging

Part Type	Packaging Type	Pieces per Box
GT-205U	Tray	10
GT-2050R		30
GT-2150R		20
GT-2100		40
GT-2150		10
GT-2200		10
GT-210U		40
GT-215U		10
GT-220U		10
GT-205J		50
GT-210J		40
GT-215J		40
GT-20301		30
GT-21001		32
GT-20302		30
GT-20501V		40
GT-21001V		10
GT-22001V		40

Handling Precautions

Precautions for product storage

EMI-RFI Filters should be stored in normal working environments. While the filters themselves are quite robust in other environments, solderability will be degraded by exposure to high temperatures, high humidity, corrosive atmospheres, and long term storage.

KEMET recommends that maximum storage temperature not exceed 40°C, maximum storage humidity not exceed 70% relative humidity, and atmospheres should be free of chlorine and sulfur bearing compounds. Temperature fluctuations should be minimized to avoid condensation on the parts. Also, avoid storage near strong magnetic fields as this might magnetize the product.

EMI-RFI Filters' stock should be used promptly, preferably within 12 months of receipt.

KEMET Electronics Corporation Sales Offices

For a complete list of our global sales offices, please visit www.kemet.com/sales.

Disclaimer

All product specifications, statements, information and data (collectively, the "Information") in this datasheet are subject to change. The customer is responsible for checking and verifying the extent to which the Information contained in this publication is applicable to an order at the time the order is placed. All Information given herein is believed to be accurate and reliable, but it is presented without guarantee, warranty, or responsibility of any kind, expressed or implied.

Statements of suitability for certain applications are based on KEMET Electronics Corporation's ("KEMET") knowledge of typical operating conditions for such applications, but are not intended to constitute – and KEMET specifically disclaims – any warranty concerning suitability for a specific customer application or use. The Information is intended for use only by customers who have the requisite experience and capability to determine the correct products for their application. Any technical advice inferred from this Information or otherwise provided by KEMET with reference to the use of KEMET's products is given gratis, and KEMET assumes no obligation or liability for the advice given or results obtained.

Although KEMET designs and manufactures its products to the most stringent quality and safety standards, given the current state of the art, isolated component failures may still occur. Accordingly, customer applications which require a high degree of reliability or safety should employ suitable designs or other safeguards (such as installation of protective circuitry or redundancies) in order to ensure that the failure of an electrical component does not result in a risk of personal injury or property damage.

Although all product-related warnings, cautions and notes must be observed, the customer should not assume that all safety measures are indicated or that other measures may not be required.

When providing KEMET products and technologies contained herein to other countries, the customer must abide by the procedures and provisions stipulated in all applicable export laws and regulations, including without limitation the International Traffic in Arms Regulations (ITAR), the US Export Administration Regulations (EAR) and the Japan Foreign Exchange and Foreign Trade Act.

KEMET is a registered trademark of KEMET Electronics Corporation.

X-ON Electronics

Largest Supplier of Electrical and Electronic Components

Click to view similar products for [Power Line Filters](#) category:

Click to view products by [Kemet](#) manufacturer:

Other Similar products are found below :

[6609026-5](#) [6609030-6](#) [6609973-2](#) [D30A](#) [F2810](#) [F7140A](#) [F7382Z](#) [F7863Z](#) [FAHAV3100ZC000](#) [806276](#) [FN2020B-1-06](#) [FN2080B-10-06](#)
[FN2090A-1-06](#) [FN2410H-32-33](#) [FN2410H-80-34](#) [FN406B-0.5-02](#) [FP144](#) [FS4153-20-06](#) [FS4353-500-99](#) [12-MMB-030-11-D](#) [DB4-393](#)
[15811T200](#) [2B1](#) [1609080-2](#) [F1100AA02](#) [F1150CC10](#) [F1500CA10](#) [F1500CA15](#) [1B1](#) [FN2020B-3-06](#) [FN2060A-3-06](#) [FN2070A-16-06](#)
[FN2090A-20-06](#) [FN2090B-12-06](#) [FN2410H-25-33](#) [FN2410H-60-34](#) [FN2410H-8-44](#) [FN2412H-8-44](#) [FN323B-6-01](#) [FN610R-3-06](#) [20EHQ7](#)
[20EHZ7](#) [20K1](#) [30B6](#) [03DRDW3](#) [03DEEG3BM](#) [100BCF6](#) [10K1](#) [5500.1055.1](#) [RWK-305-4-KL](#)