

Overview

The KEMET Organic Capacitor (KO-CAP) is a solid electrolytic capacitor with a conductive polymer cathode capable of delivering very low ESR and improved capacitance retention at high frequencies. KO-CAP combines the low ESR of multilayer ceramic, the high capacitance of aluminum electrolytic, and the volumetric efficiency of tantalum into a single surface mount package. Unlike liquid electrolyte-based capacitors, KO-CAP has a very long operational life and high ripple current capabilities.

KO-CAP Polymer Capacitors

The T528 low ESL Facedown Terminal Polymer Electrolytic combines ultra-low ESR and high capacitance in a package design that offers the lowest ESL in the market. This series offers exceptional performance for high-speed microprocessor, FPGA, or ASIC decoupling designs. The T528 utilizes a unique termination design that allows for a reduction in the inductance loop area and comes in a low profile 1.7 mm case height. This series offers improved capacitance retention at frequencies of up to 1 MHz.

Benefits

- Low ESL < 0.7 nH at 20 MHz
- Improved volumetric efficiency
- High frequency capacitance retention
- 100% accelerated steady state aging
- 100% surge current tested
- EIA standard case sizes
- Halogen-free epoxy and RoHS compliant
- Lead free 260°C reflow capable

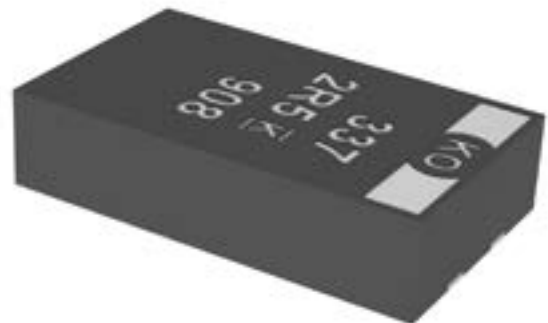

Applications

Typical applications include high speed server, microprocessor decoupling and high ripple current applications.

Environmental Compliance

RoHS Compliant when ordered with 100% Sn or Ni-Pd-Au.

- Halogen-free
- Epoxy compliant with UL94 V-0
- Molded Epoxy complies for outgassing testing under ASTM E 595.

K-SIM

For a detailed analysis of specific part numbers, please visit ksim.kemet.com to access KEMET’s K-SIM software. KEMET K-SIM is designed to simulate behavior of components with respect to frequency, ambient temperature, and DC bias levels.

Ordering Information

T	528	Z	337	M	2R5	A	T	E009	
Capacitor Class	Series	Case Size	Capacitance Code (pF)	Capacitance Tolerance	Rated Voltage (VDC)	Failure Rate/Design	Termination Finish	ESR Code	Packaging (C-Spec)
T = Tantalum	528 = Low ESL Facedown Terminal Polymer	B W Z	First two digits represent significant figures. Third digit specifies number of zeros.	M = ±20%	002 = 2 2R5 = 2.5 004 = 4 006 = 6.3	A = N/A	T = 100% Matte Tin (Sn)-plated P = Ni-Pd-Au-plated	E = ESR last three digits specify ESR in mΩ (009 = 9 mΩ)	Blank = 7" reel 7280 = 13" reel

Performance Characteristics

Item	Performance Characteristics
Operating Temperature	-55°C to 105°C
Rated Capacitance Range	150 – 470 µF at 120 Hz/25°C
Capacitance Tolerance	M Tolerance (20%)
Rated Voltage Range	2 – 6.3 V
DF (120 Hz)	≤ 10% - Refer to Part Number Electrical Specification Table
ESR (100 kHz)	Refer to Part Number Electrical Specification Table
Leakage Current	≤ 0.1 CV (µA) at rated voltage after 5 minutes

Qualification

Test	Condition	Characteristics				
Endurance	105°C at rated voltage, 2,000 hours	Δ C/C	Within -20/+10% of initial value			
		DF	≤ Initial Limit			
		DCL	Within 1.25 x initial limit			
		ESR	Within 2.0 x initial limit			
Storage Life	105°C at 0 volts, 2,000 hours	Δ C/C	Within -20/+10% of initial value			
		DF	Within initial limits			
		DCL	Within 1.25 x initial limit			
		ESR	Within 2.0 x initial limit			
Humidity	60°C, 90% RH, No Load, 500 hours	Δ C/C	Within -5/+35% of initial value			
		DF	≤ Initial limit			
		DCL	Within 5.0 x initial limit			
		ESR	Within 2.0 x initial limit			
Temperature Stability	Extreme temperature exposure at a succession of continuous steps at -55°C, +25°C, +85°C, +105°C		+25°C	-55°C	+85°C	+105°C
		Δ C/C	IL*	±20%	±20%	±30%
		DF	IL	IL	1.2 x IL	1.5 x IL
		DCL	IL	N/A	10 x IL	10 x IL
Surge Voltage	105°C, 1.32 x rated voltage 1,000 cycles	Δ C/C	Within -20/+10% of initial value			
		DF	Within initial limits			
		DCL	Within initial limits			
		ESR	Within initial limits			
Mechanical Shock/ Vibration	MIL-STD-202, Method 213, Condition I, 100 G peak MIL-STD-202, Method 204, Condition D, 10 Hz to 2,000 Hz, 20 G peak	Δ C/C	Within ±10% of initial value			
		DF	Within initial limits			
		DCL	Within initial limits			

*IL = Initial limit

Reliability

KO-CAP capacitors have an average failure rate of 0.5 %/1,000 hours at category voltage, U_C , and category temperature, T_C . These capacitors are qualified using industry test standards at U_C and T_C . The minimum test time (1,000 or 2,000 hours) is dependent on the product.

The actual life expectancy of KO-CAP capacitors increases when application voltage, U_A , and application temperature, T_A , are lower than U_C and T_C . As a general guideline, when $U_A < 0.9 * U_C$ and $T_A < 85^\circ\text{C}$, the life expectancy will typically exceed the useful lifetime of most hardware (> 10 years).

The lifetime of a KO-CAP capacitor at a specific application voltage and temperature can be modeled using the equations below. A failure is defined as passing enough current to blow a 1-Amp fuse. The calculation is an estimation based on empirical results and is not a guarantee.

$$VAF = \left(\frac{U_C}{U_A}\right)^n$$

where:
 VAF = acceleration factor due to voltage, unitless
 U_C = category voltage, volt
 U_A = application voltage, volt
 n = exponent, 16

$$TAF = e^{\left[\frac{E_a}{k} \left(\frac{1}{273+T_A} - \frac{1}{273+T_C}\right)\right]}$$

where:
 TAF = acceleration factor due to temperature, unitless
 E_a = activation energy, 1.4 eV
 k = Boltzmann's constant, 8.617E-5 eV/K
 T_A = application temperature, °C
 T_C = category temperature, °C

$$AF = VAF * TAF$$

where:
 AF = acceleration factor, unitless
 TAF = acceleration factor due to temperature, unitless
 VAF = acceleration factor due to voltage, unitless

$$Life_{U_A, T_A} = Life_{U_C, T_C} * AF$$

where:
 $Life_{U_A, T_A}$ = estimated life application voltage and temperature, years
 $Life_{U_C, T_C}$ = guaranteed life category voltage and temperature, years
 AF = acceleration factor, unitless

Reliability Table 1 – Common temperature range classifications														
85°C (T_R)/ 85°C (T_C)	Rated Voltage (U_R)	2.5	4.0	6.3	8.0	10.0	12.5	16.0	20.0	25.0	35.0	50.0	63.0	75.0
	Category Voltage (U_C)	2.5	4.0	6.3	8.0	10.0	12.5	16.0	20.0	25.0	35.0	50.0	63.0	75.0
105°C (T_R)/ 105°C (T_C)	Rated Voltage (U_R)	2.5	4.0	6.3	8.0	10.0	12.5	16.0	20.0	25.0	35.0	50.0	63.0	75.0
	Category Voltage (U_C)	2.5	4.0	6.3	8.0	10.0	12.5	16.0	20.0	25.0	35.0	50.0	63.0	75.0
105°C (T_R)/ 125°C (T_C)	Rated Voltage (U_R)	2.5	4.0	6.3	8.0	10.0	12.5	16.0	20.0	25.0	35.0	50.0	63.0	75.0
	Category Voltage (U_C)	1.7	2.7	4.2	5.4	6.7	8.4	10.7	13.4	16.8	23.5	33.5	42.2	50.3

Terms:

Category Voltage, U_C : Maximum recommended peak DC operating voltage for continuous operation at the category temperature, T_C

Rated Voltage, U_R : Maximum recommended peak DC operating voltage for continuous operation up to the rated temperature, T_R

Category Temperature, T_C : Maximum recommended operating temperature; voltage derating may be required at T_C

Rated Temperature, T_R : Maximum recommended operating temperature without voltage derating; T_R is equal to or lower than T_C

Electrical Characteristics

ESR vs. Frequency

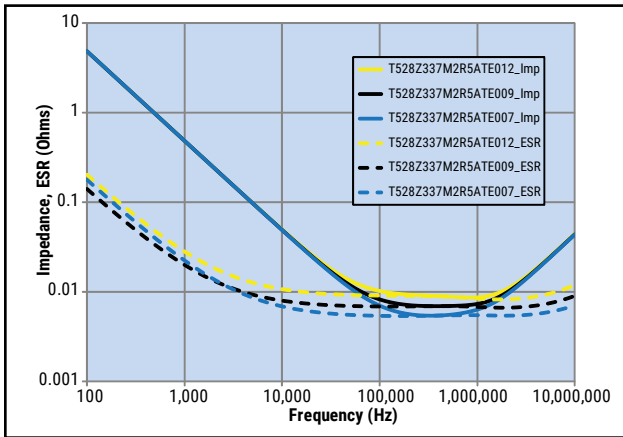

Capacitance vs. Frequency

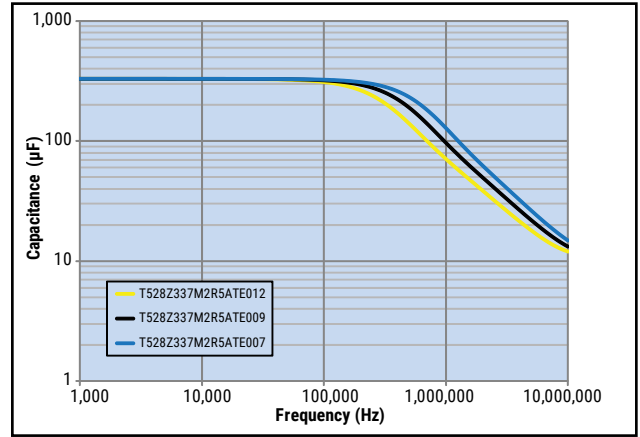

Dimensions – Millimeters

B Case

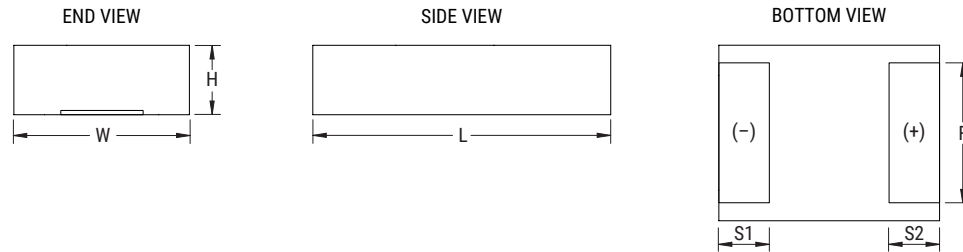

W and Z Cases

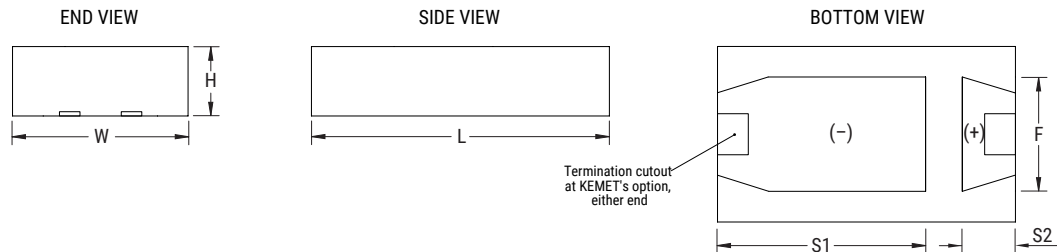

Case Size		Component Dimensions						Typical Weight
KEMET	EIA	L	W	H	F ±0.2	S1	S2	(mg)
B	3528-20	3.5 ±0.2	2.8 ±0.2	1.9 ±0.1	2.2	0.8 ±0.3	0.8 ±0.3	94.85
W	7343-15	7.3 ±0.4	4.3 ±0.3	1.4 ±0.1	2.8	5.0 ±0.4	1.3 ±0.2	222.95
Z	7343-17	7.3 ±0.4	4.3 ±0.3	1.6 ±0.1	2.8	5.0 ±0.4	1.3 ±0.2	206.33

These weights are provided as reference. If exact weights are needed, please contact your KEMET Sales Representative

Table 1 – Ratings & Part Number Reference

Rated Voltage	Rated Capacitance	Case Code/ Case Size	KEMET Part Number	DC Leakage	DF	ESR	Maximum Allowable Ripple Current	MSL	Maximum Operating Temp
VDC at 105°C	µF	KEMET/EIA	(See below for part options)	µA at +25°C Maximum/ 5 Minutes	% at +25°C 120 Hz Maximum	mΩ at +25°C 100 kHz Maximum	(rms) mA at +45°C 100 kHz	Reflow Temp ≤ 260°C	°C
2	270	B/3528-20	T528B277M002APE006	54.0	8	6	3,900	3	105
2	270	B/3528-20	T528B277M002APE009	54.0	8	9	3,200	3	105
2.5	220	Z/7343-17	T528Z227M2R5ATE006	55.0	10	6	7,400	3	105
2.5	270	B/3528-20	T528B277M2R5APE006	67.5	10	6	3,900	3	105
2.5	270	B/3528-20	T528B277M2R5APE009	67.5	10	9	3,200	3	105
2.5	330	W/7343-15	T528W337M2R5ATE009	82.5	10	9	6,000	3	105
2.5	330	Z/7343-17	T528Z337M2R5ATE005	82.5	10	5	8,100	3	105
2.5	330	Z/7343-17	T528Z337M2R5ATE006	82.5	10	6	7,400	3	105
2.5	330	Z/7343-17	T528Z337M2R5ATE007	82.5	10	7	6,800	3	105
2.5	330	Z/7343-17	T528Z337M2R5ATE008	82.5	10	8	6,400	3	105
2.5	330	Z/7343-17	T528Z337M2R5ATE009	82.5	10	9	6,000	3	105
2.5	330	Z/7343-17	T528Z337M2R5ATE012	82.5	10	12	5,200	3	105
2.5	470	Z/7343-17	T528Z477M2R5ATE005	117.5	10	5	8,100	3	105
2.5	470	Z/7343-17	T528Z477M2R5ATE006	117.5	10	6	7,400	3	105
2.5	470	Z/7343-17	T528Z477M2R5ATE008	117.5	10	8	6,400	3	105
2.5	470	Z/7343-17	T528Z477M2R5ATE009	117.5	10	9	6,000	3	105
2.5	470	Z/7343-17	T528Z477M2R5ATE012	117.5	10	12	5,200	3	105
4	220	Z/7343-17	T528Z227M004ATE007	88.0	10	7	6,800	3	105
4	220	Z/7343-17	T528Z227M004ATE008	88.0	10	8	6,400	3	105
4	220	Z/7343-17	T528Z227M004ATE009	88.0	10	9	6,000	3	105
4	220	Z/7343-17	T528Z227M004ATE012	88.0	10	12	5,200	3	105
4	330	Z/7343-17	T528Z337M004ATE009	132.0	10	9	6,000	3	105
4	330	Z/7343-17	T528Z337M004ATE012	132.0	10	12	5,200	3	105
6.3	150	Z/7343-17	T528Z157M006ATE007	94.5	10	7	6,800	3	105
6.3	150	Z/7343-17	T528Z157M006ATE008	94.5	10	8	6,400	3	105
6.3	150	Z/7343-17	T528Z157M006ATE009	94.5	10	9	6,000	3	105
6.3	150	Z/7343-17	T528Z157M006ATE012	94.5	10	12	5,200	3	105
6.3	220	Z/7343-17	T528Z227M006ATE009	138.6	10	9	6,000	3	105
6.3	220	Z/7343-17	T528Z227M006ATE012	138.6	10	12	5,200	3	105
VDC at 105°C	µF	KEMET/EIA	(See below for part options)	µA at +25°C Maximum/ 5 Minutes	% at +25°C 120 Hz Maximum	mΩ at +25°C 100 kHz Maximum	(rms) mA at +45°C 100 kHz	Reflow Temp ≤ 260°C	°C
Rated Voltage	Rated Capacitance	Case Code/ Case Size	KEMET Part Number	DC Leakage	DF	ESR	Maximum Allowable Ripple Current	MSL	Maximum Operating Temp

Other part number options:

1- Standard with tin terminations (14th character = T). Tin/lead terminations is also available (14th character = H).

Also available on large (13 inch) reels. Add 7280 to the end of the part number.

Higher voltage ratings and tighter tolerance product including ESR may be substituted within the same size at KEMET's option. Voltage substitutions will be marked with the higher voltage rating. Substitutions can include better than series.

Derating Guidelines

Voltage Rating	Maximum Recommended Steady State Voltage
-55°C to 105°C	
$2\text{ V} \leq V_R \leq 6.3\text{ V}$	90% of V_R

V_R = Rated Voltage

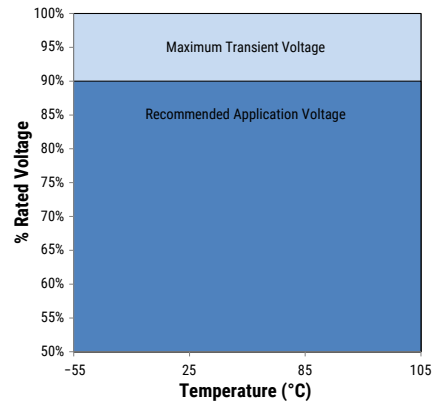

Ripple Current/Ripple Voltage

Permissible AC ripple voltage and current are related to equivalent series resistance (ESR) and the power dissipation capabilities of the device. Permissible AC ripple voltage which may be applied is limited by two criteria:

1. The positive peak AC voltage plus the DC bias voltage, if any, must not exceed the DC voltage rating of the capacitor.
2. The negative peak AC voltage in combination with bias voltage, if any, must not exceed the allowable limits specified for reverse voltage. See the Reverse Voltage section for allowable limits.

The maximum power dissipation by case size can be determined using the table at right. The maximum power dissipation rating stated in the table must be reduced with increasing environmental operating temperatures. Refer to the table below for temperature compensation requirements.

KEMET Case Code	EIA Case Code	Maximum Power Dissipation (Pmax) mWatts at 45°C with +30°C Rise
B	3528-20	127
W	7343-15	325
Z	7343-17	325

Using the P max of the device, the maximum allowable rms ripple current or voltage may be determined.

$$I(max) = \sqrt{P_{max}/R}$$

$$E(max) = Z \sqrt{P_{max}/R}$$

I = rms ripple current (amperes)
 E = rms ripple voltage (volts)
 P_{max} = maximum power dissipation (watts)
 R = ESR at specified frequency (ohms)
 Z = Impedance at specified frequency (ohms)

Temperature Compensation Multipliers for Maximum Ripple Current		
$T \leq 45^\circ\text{C}$	$45^\circ\text{C} < T \leq 85^\circ\text{C}$	$85^\circ\text{C} < T \leq 125^\circ\text{C}$
1.00	0.70	0.25

T = Environmental Temperature

The maximum power dissipation rating must be reduced with increasing environmental operating temperatures. Refer to the Temperature Compensation Multiplier table for details.

Reverse Voltage

Polymer electrolytic capacitors are polar devices and may be permanently damaged or destroyed if connected in the wrong polarity. These devices will withstand a small degree of transient voltage reversal for short periods as shown in the below table.

Temperature	Permissible Transient Reverse Voltage
25°C	15% of Rated Voltage
55°C	10% of Rated Voltage
85°C	5% of Rated Voltage
105°C	3% of Rated Voltage
125°C*	1% of Rated Voltage

*For Series Rated to 125°C

Table 2 – Land Dimensions/Courtyard

KEMET Case	Metric Size Code	Density Level A: Maximum (Most) Land Protrusion (mm)							Density Level B: Median (Nominal) Land Protrusion (mm)							Density Level C: Minimum (Least) Land Protrusion (mm)						
		L1	L2	W	S1	S2	V1	V2	L1	L2	W	S1	S2	V1	V2	L1	L2	W	S1	S2	V1	V2
B	3528-20	2.20	2.20	2.35	0.46	0.46	6.32	4.00	1.80	1.80	2.23	0.56	0.56	5.22	3.50	1.42	1.42	2.13	0.64	0.64	4.36	3.24
W ¹	7343-15	6.48	2.68	3.04	-1.82	1.98	10.32	5.60	6.18	2.38	2.92	-1.82	1.98	9.22	5.10	5.82	2.02	2.82	-1.76	2.04	8.36	4.84
Z ¹	7343-17	6.48	2.68	3.04	-1.82	1.98	10.32	5.60	6.18	2.38	2.92	-1.82	1.98	9.22	5.10	5.82	2.02	2.82	-1.76	2.04	8.36	4.84

Density Level A: For low-density product applications. Recommended for wave solder applications and provides a wider process window for reflow solder processes.

Density Level B: For products with a moderate level of component density. Provides a robust solder attachment condition for reflow solder processes.

Density Level C: For high component density product applications. Before adapting the minimum land pattern variations the user should perform qualification testing based on the conditions outlined in IPC standard 7351 (IPC-7351).

¹ Negative values of S1 mean that pad lies at the center's right side.

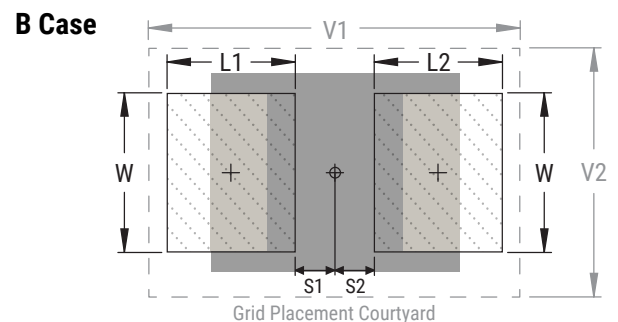
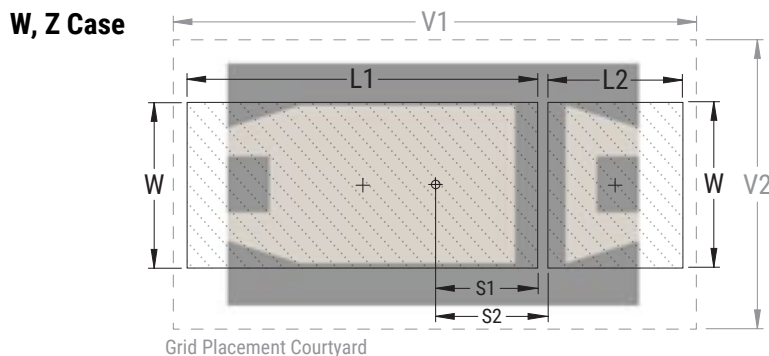

Soldering Process

KEMET’s families of surface mount capacitors are compatible with wave (single or dual), convection, IR, or vapor phase reflow techniques. Preheating of these components is recommended to avoid extreme thermal stress. KEMET’s recommended profile conditions for convection and IR reflow reflect the profile conditions of the IPC/J-STD-020D standard for moisture sensitivity testing. The devices can safely withstand a maximum of three reflow passes at these conditions.

Please note that although the X/7343-43 case size can withstand wave soldering, the tall profile (4.3 mm maximum) dictates care in wave process development.

Hand soldering should be performed with care due to the difficulty in process control. If performed, care should be taken to avoid contact of the soldering iron to the molded case. The iron should be used to heat the solder pad, applying solder between the pad and the termination, until reflow occurs. Once reflow occurs, the iron should be removed immediately. “Wiping” the edges of a chip and heating the top surface is not recommended.

Profile Feature	SnPb Assembly	Pb-Free Assembly
Preheat/Soak		
Temperature Minimum (T_{smin})	100°C	150°C
Temperature Maximum (T_{smax})	150°C	200°C
Time (t_s) from T_{smin} to T_{smax}	60 – 120 seconds	60 – 120 seconds
Ramp-up Rate (T_L to T_P)	3°C/second maximum	3°C/second maximum
Liquidous Temperature (T_L)	183°C	217°C
Time Above Liquidous (t_L)	60 – 150 seconds	60 – 150 seconds
Peak Temperature (T_P)	220°C* 235°C**	250°C* 260°C**
Time within 5°C of Maximum Peak Temperature (t_p)	20 seconds maximum	30 seconds maximum
Ramp-down Rate (T_P to T_L)	6°C/second maximum	6°C/second maximum
Time 25°C to Peak Temperature	6 minutes maximum	8 minutes maximum

Note: All temperatures refer to the center of the package, measured on the package body surface that is facing up during assembly reflow.

* For Case Size height > 2.5 mm

** For Case Size height ≤ 2.5 mm

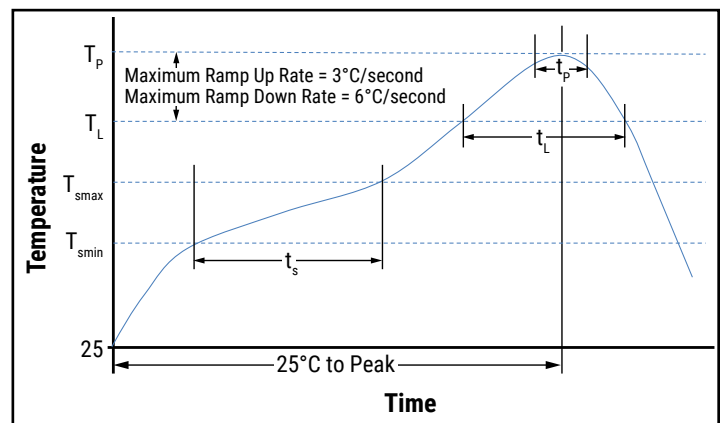

Storage

All KO-CAP series are shipped in moisture barrier bags (MBBs) with desiccant and humidity indicator card (HIC). These parts are classified as MSL3 (Moisture Sensitivity Level 3) per IPC/JEDEC J-STD-020 and packaged per IPC/JEDEC J-STD-033. MSL3 specifies a floor time of 168 H at 30°C maximum temperature and 60% relative humidity. Unused capacitors should be sealed in a MBB with fresh desiccant.

The calculated shelf life in a sealed bag would be 12 months from a bag seal date in a storage environment of < 40°C and humidity < 90% RH. It should be 24 months from a bag seal date in a storage environment of < 30°C and humidity < 70% RH.

If baking is required, refer to IPC/JEDEC J-STD-033 for bake procedure.

Construction

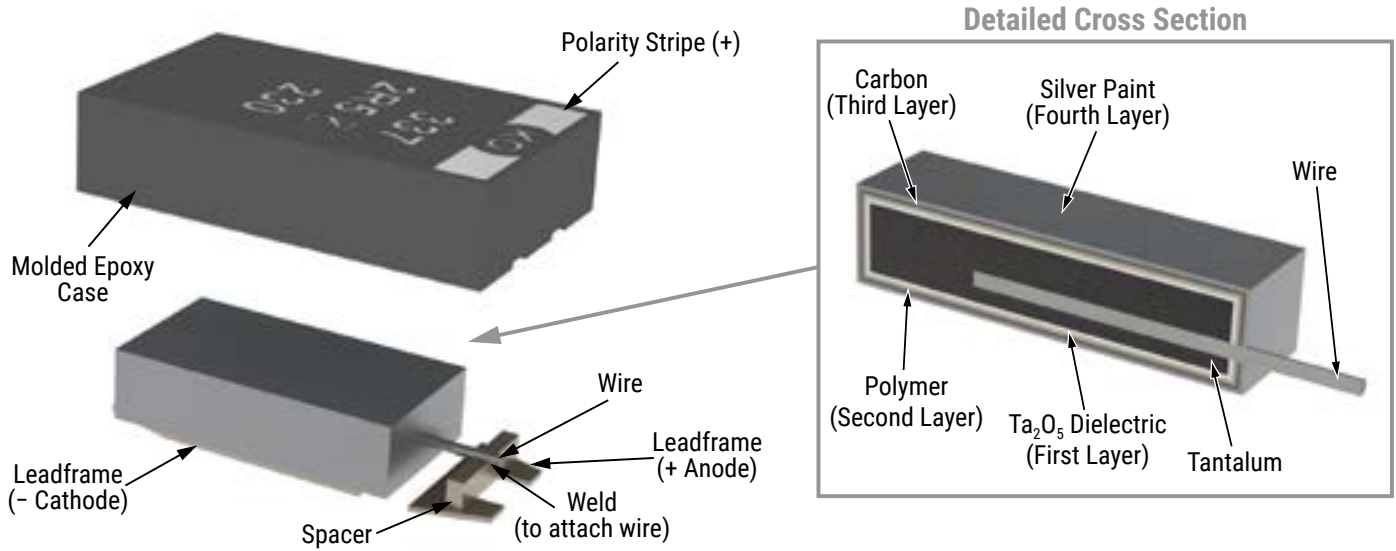

Capacitor Marking

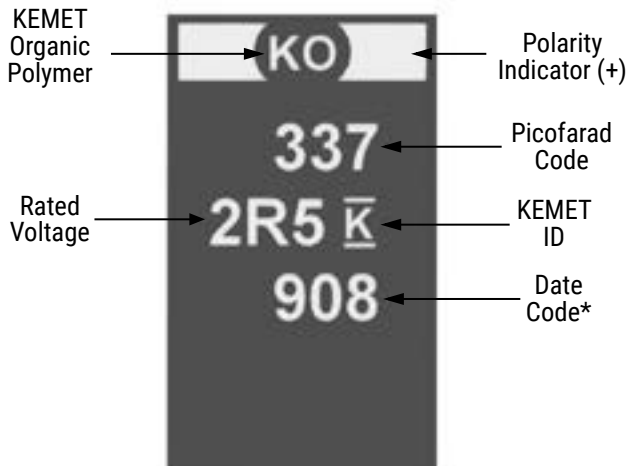

* 908 = 8th week of 2019

Date Code *	
1 st digit = last number of year	6 = 2016 7 = 2017 8 = 2018 9 = 2019 0 = 2020
2 nd and 3 rd digit = week of the year	01 = 1 st week of the year to 52 = 52 nd week of the year

Tape & Reel Packaging Information

KEMET’s molded chip capacitor families are packaged in 8 and 12 mm plastic tape on 7" and 13" reels in accordance with *EIA Standard 481: Embossed Carrier Taping of Surface Mount Components for Automatic Handling*. This packaging system is compatible with all tape-fed automatic pick-and-place systems.



Table 3 – Packaging Quantity

Case Code		Tape Width (mm)	7" Reel*	13" Reel*
KEMET	EIA			
P	2012-10	8	3,000	N/A
R	2012-12	8	2,500	10,000
I	3216-10	8	3,000	N/A
S	3216-12	8	2,500	10,000
A	3216-18	8	2,000	N/A
T	3528-12	8	3,000	10,000
M	3528-15	8	2,500	8,000
B	3528-21	8	2,000	8,000
U	6032-15	12	1,000	5,000
L	6032-19	12	1,000	3,000
C	6032-28	12	500	3,000
Q	7343-12	12	1,000	3,000
W	7343-15	12	1,000	3,000
Z	7343-17	12	1,000	3,000
V	7343-19	12	1,000	3,000
D	7343-31	12	500	2,500
Y	7343-40	12	500	2,000
X	7343-43	12	500	2,000
J	7360-15	12	1,000	3,000
H	7360-20	12	1,000	3,000
O	7360-43	12	250	1,000

* No C-Spec required for 7" reel packaging. C-7280 required for 13" reel packaging.

Figure 1 – Embossed (Plastic) Carrier Tape Dimensions

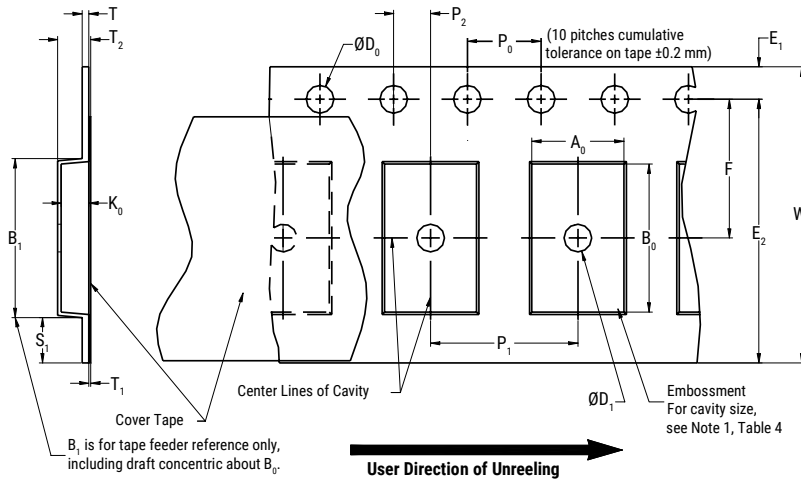

Table 4 – Embossed (Plastic) Carrier Tape Dimensions

Metric will govern

Constant Dimensions – Millimeters (Inches)									
Tape Size	D_0	D_1 Minimum Note 1	E_1	P_0	P_2	R Reference Note 2	S_1 Minimum Note 3	T Maximum	T_1 Maximum
8 mm	$1.5 \pm 0.10 / -0.0$ (0.059 + 0.004 / -0.0)	1.0 (0.039)	1.75 ± 0.10 (0.069 ± 0.004)	4.0 ± 0.10 (0.157 ± 0.004)	2.0 ± 0.05 (0.079 ± 0.002)	25.0 (0.984)	0.600 (0.024)	0.600 (0.024)	0.100 (0.004)
12 mm		1.5 (0.059)							

Variable Dimensions – Millimeters (Inches)									
Tape Size	Pitch	B_1 Maximum Note 4	E_2 Minimum	F	P_1	T_2 Maximum	W Maximum	A_0, B_0 & K_0	
8 mm	Single (4 mm)	4.35 (0.171)	6.25 (0.246)	3.5 ± 0.05 (0.138 ± 0.002)	2.0 ± 0.05 or 4.0 ± 0.10 (0.079 ± 0.002 or 0.157 ± 0.004)	2.5 (0.098)	8.3 (0.327)	Note 5	
12 mm	Single (4 mm) and Double (8 mm)	8.2 (0.323)	10.25 (0.404)	5.5 ± 0.05 (0.217 ± 0.002)	2.0 ± 0.05 (0.079 ± 0.002) or 4.0 ± 0.10 (0.157 ± 0.004) or 8.0 ± 0.10 (0.315 ± 0.004)	4.6 (0.181)	12.3 (0.484)		

1. The embossment hole location shall be measured from the sprocket hole controlling the location of the embossment. Dimensions of embossment location and hole location shall be applied independent of each other.
2. The tape, with or without components, shall pass around R without damage (see Figure 4).
3. If $S_1 < 1.0$ mm, there may not be enough area for cover tape to be properly applied (see EIA Standard 481-D, paragraph 4.3, section b).
4. B_1 dimension is a reference dimension for tape feeder clearance only.
5. The cavity defined by A_0, B_0 and K_0 shall surround the component with sufficient clearance that:
 - (a) the component does not protrude above the top surface of the carrier tape.
 - (b) the component can be removed from the cavity in a vertical direction without mechanical restriction, after the top cover tape has been removed.
 - (c) rotation of the component is limited to 20° maximum for 8 and 12 mm tapes (see Figure 2).
 - (d) lateral movement of the component is restricted to 0.5 mm maximum for 8 mm and 12 mm wide tape (see Figure 3).
 - (e) see Addendum in EIA Standard 481-D for standards relating to more precise taping requirements.

Packaging Information Performance Notes

- 1. Cover tape break force:** 1.0 kg minimum.
- 2. Cover tape peel strength:** The total peel strength of the cover tape from the carrier tape shall be:

Tape Width	Peel Strength
8 mm	0.1 to 1.0 newton (10 to 100 gf)
12 mm	0.1 to 1.3 newton (10 to 130 gf)

The direction of the pull shall be opposite the direction of the carrier tape travel. The pull angle of the carrier tape shall be 165° to 180° from the plane of the carrier tape. During peeling, the carrier and/or cover tape shall be pulled at a velocity of 300 ±10 mm/minute.

- 3. Labeling:** Bar code labeling (standard or custom) shall be on the side of the reel opposite the sprocket holes. Refer to EIA Standards 556 and 624.

Figure 2 – Maximum Component Rotation

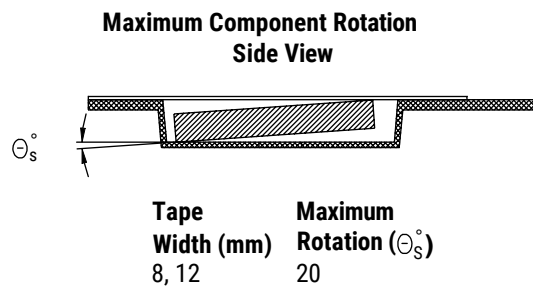
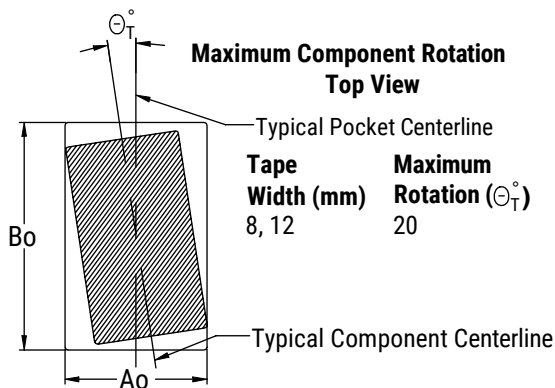

Figure 3 – Maximum Lateral Movement



Figure 4 – Bending Radius

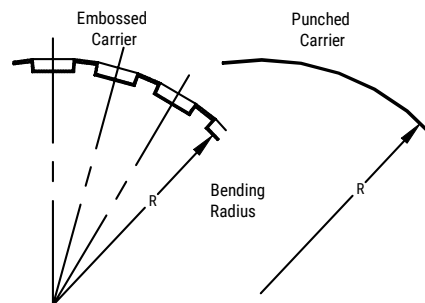

Figure 5 – Reel Dimensions



Note: Drive spokes optional; if used, dimensions B and D shall apply.

Table 5 – Reel Dimensions

Metric will govern

Constant Dimensions – Millimeters (Inches)				
Tape Size	A	B Minimum	C	D Minimum
8 mm	178 ±0.20 (7.008 ±0.008)	1.5 (0.059)	13.0 +0.5/-0.2 (0.521 +0.02/-0.008)	20.2 (0.795)
12 mm	330 ±0.20 (13.000 ±0.008)			
Variable Dimensions – Millimeters (Inches)				
Tape Size	N Minimum	W ₁	W ₂ Maximum	W ₃
8 mm	50 (1.969)	8.4 +1.5/-0.0 (0.331 +0.059/-0.0)	14.4 (0.567)	Shall accommodate tape width without interference
12 mm		12.4 +2.0/-0.0 (0.488 +0.078/-0.0)	18.4 (0.724)	

Figure 6 – Tape Leader & Trailer Dimensions



Figure 7 – Maximum Camber



KEMET Electronics Corporation Sales Offices

For a complete list of our global sales offices, please visit www.kemet.com/sales.

Disclaimer

All product specifications, statements, information and data (collectively, the "Information") in this datasheet are subject to change. The customer is responsible for checking and verifying the extent to which the Information contained in this publication is applicable to an order at the time the order is placed. All Information given herein is believed to be accurate and reliable, but it is presented without guarantee, warranty, or responsibility of any kind, expressed or implied.

Statements of suitability for certain applications are based on KEMET Electronics Corporation's ("KEMET") knowledge of typical operating conditions for such applications, but are not intended to constitute – and KEMET specifically disclaims – any warranty concerning suitability for a specific customer application or use. The Information is intended for use only by customers who have the requisite experience and capability to determine the correct products for their application. Any technical advice inferred from this Information or otherwise provided by KEMET with reference to the use of KEMET's products is given gratis, and KEMET assumes no obligation or liability for the advice given or results obtained.

Although KEMET designs and manufactures its products to the most stringent quality and safety standards, given the current state of the art, isolated component failures may still occur. Accordingly, customer applications which require a high degree of reliability or safety should employ suitable designs or other safeguards (such as installation of protective circuitry or redundancies) in order to ensure that the failure of an electrical component does not result in a risk of personal injury or property damage.

Although all product-related warnings, cautions and notes must be observed, the customer should not assume that all safety measures are indicated or that other measures may not be required.

KEMET is a registered trademark of KEMET Electronics Corporation.

X-ON Electronics

Largest Supplier of Electrical and Electronic Components

Click to view similar products for [Tantalum Capacitors - Polymer category](#):

Click to view products by [Kemet manufacturer](#):

Other Similar products are found below :

[2R5TAE680ML](#) [NTP337M2.5TRV\(25\)F](#) [T58BB226M025C0150](#) [23484-337](#) [TCJP105M025R0500E](#) [TCJA226M016R0300E](#)
[TCN4227M020R0100E](#) [TCN4227M016R0070E](#) [TCJD157M010R0055E](#) [TCJD227M006R0035E](#) [TCJD337M006R0050E](#)
[TCJD337M004R0040E](#) [TCJD227M016R0050E](#) [TCJD106M050R0090E](#) [TCJD157M016R0050E](#) [TCJA336M016R0200E](#)
[TCJB157M006R0035E](#) [TCJD337M010R0025E](#) [T591D476M020ATE050](#) [T58BB476M016C0200](#) [TCME337M010R0015E](#)
[TCQD227M004R0025E](#) [TCJY227M010R0015](#) [T520D227M2R5ATE040](#) [T520Y687M004ATE025](#) [T521D106M050ANE090](#)
[T521D186M050ATE090](#) [T521D476M016ATE090](#) [T541X337M010AH6530](#) [T541X687M006AH6510](#) [T59EE156M063E0100](#)
[TCQY336M016R0070E](#) [TCBD157M006CRSZ0H00E](#) [T520V157M004ATE015](#) [T520T106M12RATE150](#) [T545V476M016ATE045](#)
[T527I107M006ATE200](#) [T523H157M025APE070](#) [T525B336M006AHE080](#) [F381A336MSALZT](#) [FA1E566M10126VR](#)
[T520X477M006AHE040](#) [T541X336M050BH6710](#) [T541X337M016BH6720](#) [293D106X9025C2WE3](#) [NTP106M10TRB\(200\)F](#)
[NTP157M10TRD\(40\)F](#) [NTP337M2.5TRV\(15\)F](#) [NTP157M10TRD\(55\)F](#) [NTP686M4TRA\(180\)F](#)