

Overview

The KEMET Tantalum Stacks MnO₂ (TSM) is designed to provide the highest capacitance/voltage ratings in surface mount configuration. KEMET's T493 COTS military/aerospace capacitors are utilized in stacks of 2, 3, 4, and 6 components to achieve a broad range of capacitance and voltage ratings. The T493 COTS offers component level Weibull grading options, surge current testing options and standard, low, and ultra-low ESR options. All component

level lots of this product are conditioned with MIL-PRF-55365 Group A testing. Stacking configurations offer this high reliability product with custom capacitance/voltage solutions and very low ESR options.

Note: Custom stacking solutions are available with other KEMET Tantalum MnO₂ Surface Mount products. Please contact KEMET Sales for availability.

Benefits

- High capacitance
- Surface mountable
- Capacitance values of 9.4 – 2,000 µF
- Capacitance can be custom specified
- Voltage ratings of 6 VDC to 50 VDC
- High volumetric efficiency
- Ultra-low ESR
- Surge capability
- Weibull failure options B and C
- Operating temperature range of -55°C to +125°C
- Laser-marked case
- Discrete components EIA standard case sizes (others available)
- High Temperature lead attach material available (> 260°C)



Applications

Typical applications include decoupling and filtering in a variety of market segments. The T493 COTS stack devices can be utilized in military and aerospace applications. Other KEMET series can be utilized in filtering and decoupling applications to service various market segments.

Environmental Compliance

RoHS compliant when ordered with 100% Sn solder on both terminations (component and stack)

- Halogen-free
- Epoxy compliant with UL94 V-0
- Molded Epoxy complies for outgassing testing under ASTM E 595.

K-SIM

For a detailed analysis of specific part numbers, please visit ksim.kemet.com to access KEMET's K-SIM software. KEMET K-SIM is designed to simulate behavior of components with respect to frequency, ambient temperature, and DC bias levels.

Ordering Information

| T | SM | 2D | 447 | K | 10 | A | H | 61 | 20 | D493 |
|-----------------|---------------------------------|--|--|-----------------------|---|--|---|---|---|---|
| Capacitor Class | Series | Case Size | Capacitance Code (pF) | Capacitance Tolerance | Rated Voltage (VDC) | Failure Rate/ Design | Termination Finish | Surge | ESR | C-Spec 2 |
| T = Tantalum | Stacks MnO ₂ cathode | 2C, 3C, 4C, 6C, 2D, 3D, 4D, 6D, 2X, 3X, 4X, 6X | First two digits represent significant figures. Third digit specifies number of zeros. | K = ±10% M = ±20% | 006 = 6.3 010 = 10 016 = 16 020 = 20 025 = 25 035 = 35 050 = 50 | A = N/A B = 0.1%/1,000 hours C = 0.01%/1,000 hours | H = Standard solder-coated (SnPb 5% Pb minimum) C = Hot solder dipped B = Gold-plated T = 100% Tin | 61 = None 62 = 10 Cycles 25°C after Weibull 63 = 10 cycles, -55°C and 85°C after Weibull 64 = 10 cycles, -55°C and 85°C before Weibull | 10 = ESR - standard 20 = ESR - low 30 = ESR - ultra-low | First digit represents outer leadframe finish D = Silver-plated (Ag) H = Solder-plated (SnPb 5% Pb minimum) T = 100% Tin (Sn) Second, third, and fourth digit designates discrete component series. 493 = T493 |

Note: Custom discrete component stacking solutions are also available with other KEMET Polymer Electrolytic Surface Mount series/products. Please contact KEMET Sales for availability.

Performance Characteristics

| Item | Performance Characteristics |
|-------------------------|---|
| Operating Temperature | -55°C to 125°C |
| Rated Capacitance Range | 9.4 – 2,000 µF at 120 Hz/25°C |
| Capacitance Tolerance | K Tolerance (10%), M Tolerance (20%) |
| Rated Voltage Range | 6 – 50 V |
| DF (120 Hz) | Refer to Part Number Electrical Specification Table |
| ESR (100 kHz) | Refer to Part Number Electrical Specification Table |
| Leakage Current | ≤ 0.01 CV (µA) at rated voltage after 5 minutes |

Qualification

| Test | Condition | Characteristics | |
|----------------------|---|-----------------|------------------------------|
| Endurance | 85°C at rated voltage, 2,000 hours 125°C at 2/3 rated voltage, 2,000 hours | Δ C/C | Within ±10% of initial value |
| | | DF | Within initial limits |
| | | DCL | Within 1.25 x initial limit |
| | | ESR | Within initial limits |
| Thermal Shock | KEMET specified test, mounted, -55°C to 125°C, 5 cycles | Δ C/C | Within ±5% of initial value |
| | | DF | Within initial limits |
| | | DCL | Within 1.25 x initial limit |
| | | ESR | Within initial limits |
| Surge Voltage | 85°C, 1.15 x rated voltage 1,000 cycles | Δ C/C | Within ±5% of initial value |
| | | DF | Within initial limits |
| | | DCL | Within initial limits |
| | | ESR | Within initial limits |
| Surge Voltage | 125°C, 0.77 x rated voltage 1,000 cycles | Δ C/C | Within ±5% of initial value |
| | | DF | Within initial limits |
| | | DCL | Within initial limits |
| | | ESR | Within initial limits |
| Mechanical Vibration | MIL-STD-202, Method 204, Condition D, 10 Hz to 2,000 Hz, 20 G peak | Δ C/C | Within ±10% of initial value |
| | | DF | Within initial limits |
| | | DCL | Within initial limits |

Dimensions – Millimeters (Inches)

Metric will govern

TSM2

| KEMET 2 Component Stack Dimensions | | | | | | |
|------------------------------------|---------------------------|--------------------------|---------------------------|--------------------------|---------------------------|---------------------------|
| Case Code | L | W | H | W ₂ | H ₂ | P |
| 2C | 6.5±0.38 (0.258±0.015) | 3.3±0.2 (0.130±0.008) | 5.3±0.38 (0.210±0.015) | 2.5±0.2 (0.100±0.008) | 4.5±0.38 (0.176±0.015) | 1.4±0.38 (0.055±0.015) |
| 2D | 8.0±0.38 (0.315±0.015) | 4.4±0.2 (0.174±0.008) | 6.2±0.38 (0.245±0.015) | 3.0±0.2 (0.120±0.008) | 4.8±0.38 (0.192±0.015) | 1.9±.38 (0.075±0.015) |
| 2X | 8.0±0.38 (0.315±0.015) | 4.4±0.2 (0.174±0.008) | 8.9±0.38 (0.352±0.015) | 3.0±0.2 (0.120±0.008) | 6.9±0.38 (0.272±0.015) | 1.9±0.38 (0.075±0.015) |

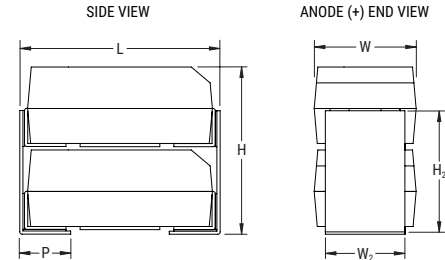

TSM3

| KEMET 3 Component Stack Dimensions | | | | | | |
|------------------------------------|---------------------------|--------------------------|----------------------------|--------------------------|----------------------------|---------------------------|
| Case Code | L | W | H | W ₂ | H ₂ | P |
| 3C | 6.5±0.38 (0.258±0.015) | 3.3±0.2 (0.130±0.008) | 7.8±0.38 (0.310±0.015) | 2.5±0.2 (0.100±0.008) | 6.4±0.38 (0.252±0.015) | 1.4±0.38 (0.055±0.015) |
| 3D | 8.0±0.38 (0.315±0.015) | 4.4±0.2 (0.174±0.008) | 9.2±0.38 (0.365±0.015) | 3.0±0.2 (0.120±0.008) | 7.7±0.38 (0.304±0.015) | 1.9±0.38 (0.075±0.015) |
| 3X | 8.0±0.38 (0.315±0.015) | 4.4±0.2 (0.174±0.008) | 13.3±0.38 (0.525±0.015) | 3.0±0.2 (0.120±0.008) | 11.0±0.38 (0.436±0.015) | 1.9±0.38 (0.075±0.015) |

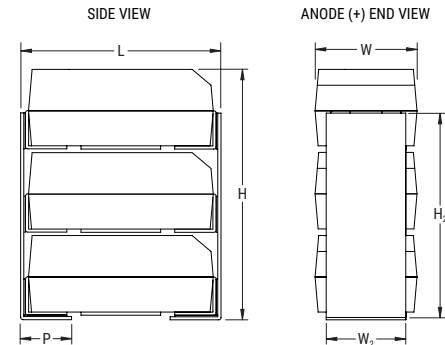

TSM4

| KEMET 4 Component Stack Dimensions | | | | | | |
|------------------------------------|---------------------------|--------------------------|---------------------------|--------------------------|---------------------------|---------------------------|
| Case Code | L | W | H | W ₂ | H ₂ | P |
| 4C | 6.5±0.38 (0.258±0.015) | 6.6±0.2 (0.262±0.008) | 5.3±0.38 (0.210±0.015) | 5.8±0.2 (0.230±0.008) | 4.6±0.38 (0.180±0.015) | 1.4±0.38 (0.055±0.015) |
| 4D | 8.0±0.38 (0.315±0.015) | 8.9±0.2 (0.350±0.008) | 6.2±0.38 (0.245±0.015) | 7.4±0.2 (0.292±0.008) | 4.8±0.38 (0.192±0.015) | 1.9±0.38 (0.075±0.015) |
| 4X | 8.0±0.38 (0.315±0.015) | 8.9±0.2 (0.350±0.008) | 8.9±0.38 (0.352±0.015) | 7.4±0.2 (0.292±0.008) | 6.9±0.38 (0.272±0.015) | 1.9±0.38 (0.075±0.015) |

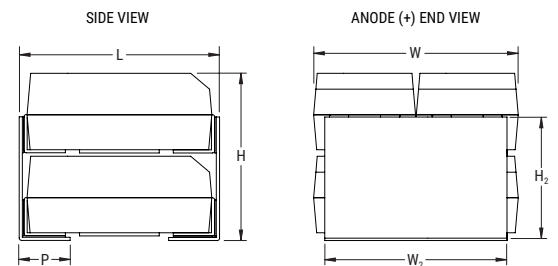

TSM6

| KEMET 6 Component Stack Dimensions | | | | | | |
|------------------------------------|---------------------------|--------------------------|----------------------------|--------------------------|----------------------------|---------------------------|
| Case Code | L | W | H | W ₂ | H ₂ | P |
| 6C | 6.5±0.38 (0.258±0.015) | 6.6±0.2 (0.262±0.008) | 7.8±0.38 (0.310±0.015) | 5.8±0.2 (0.230±0.008) | 6.6±0.38 (0.260±0.015) | 1.4±0.38 (.055±0.015) |
| 6D | 8.0±0.38 (0.315±0.015) | 8.9±0.2 (0.350±0.008) | 9.2±0.38 (0.365±0.015) | 7.4±0.2 (0.292±0.008) | 7.7±0.38 (0.304±0.015) | 1.9±0.38 (0.075±0.015) |
| 6X | 8.0±0.38 (0.315±0.015) | 8.9±0.2 (0.350±0.008) | 13.3±0.38 (0.525±0.015) | 7.4±0.2 (0.292±0.008) | 11.0±0.38 (0.436±0.015) | 1.9±0.38 (0.075±0.015) |



Capacitance & Rated Voltage Chart

| Capacitance | | Rated Voltage | | | | | | |
|-------------|------|---------------|--------|------|--------|------|------|------|
| µF | Code | 6 V | 10 V | 16 V | 20 V | 25 V | 35 V | 50 V |
| 9.4 | 945 | | | | | | | 2D |
| 14 | 146 | | | | | | | 3D |
| 19 | 196 | | | | | | | 4D |
| 20 | 206 | | | | | | 2C | 2X |
| 28 | 286 | | | | | | | 6D |
| 30 | 306 | | | | | 2C | 3C | 3X |
| 40 | 406 | | | | | | 4C | 4X |
| 44 | 446 | | | | 2C | | 2D | |
| 45 | 456 | | | | | 3C | | |
| 60 | 606 | | | | | 4C | 6C | 6X |
| 66 | 666 | | | | 3C | | 3D | |
| 88 | 886 | | | | 4C | | 4D | |
| 90 | 906 | | | | | 6C | | |
| 94 | 946 | | | 2C | | 2D | | |
| 130 | 137 | | | | 6C, 2D | | 6D | |
| 140 | 147 | | | 3C | | 3D | | |
| 190 | 197 | | | 4C | | 4D | | |
| 200 | 207 | | 2C | | 3D | | | |
| 270 | 277 | | | | 4D | | | |
| 280 | 287 | | | 6C | | 6D | | |
| 300 | 307 | | 3C | 2D | | | | |
| 400 | 407 | | 4C | | | | | |
| 410 | 417 | | | | 6D | | | |
| 440 | 447 | 2C | 2D | | | | | |
| 450 | 457 | | | 3D | | | | |
| 600 | 607 | | 6C | 4D | | | | |
| 660 | 667 | 3C, 2D | 3D, 2X | | | | | |
| 880 | 887 | 4C | 4D | | | | | |
| 900 | 907 | | | 6D | | | | |
| 990 | 997 | 3D | 3X | | | | | |
| 1300 | 138 | 6C, 4D | 6D, 4X | | | | | |
| 2000 | 208 | 6D | 6X | | | | | |

Table 1A – TSM2 Ratings & Part Number Reference

| Rated Voltage | Rated Capacitance | Case Code/ Case Size | KEMET Part Number | DC Leakage | DF | Standard ESR | Low ESR | Ultra-low ESR | Maximum Operating Temp | MSL |
|---------------|-------------------|-------------------------|------------------------------|-----------------------------------|---------------------------|---------------------------|---------------------------|---------------------------|------------------------|---------------------|
| VDC @ 85°C | µF | KEMET/EIA | (See below for part options) | µA at +25°C Maximum/ 5 Minutes | % at +25°C 120 Hz Maximum | Ω at 25°C 100 kHz Maximum | Ω at 25°C 100 kHz Maximum | Ω at 25°C 100 kHz Maximum | °C | Reflow Temp ≤ 260°C |
| 6.3 | 440 | 2C | TSM2C447(1)006(2)(3)(4)(5) | 27.8 | 10 | 0.600 | 0.150 | 0.120 | 125 | 1 |
| 10 | 200 | 2C | TSM2C207(1)010(2)(3)(4)(5) | 20.0 | 8 | 0.600 | 0.150 | NA | 125 | 1 |
| 16 | 94 | 2C | TSM2C946(1)016(2)(3)(4)(5) | 15.0 | 6 | 0.600 | 0.250 | 0.175 | 125 | 1 |
| 20 | 44 | 2C | TSM2C446(1)020(2)(3)(4)(5) | 8.8 | 6 | 0.600 | 0.200 | NA | 125 | 1 |
| 25 | 30 | 2C | TSM2C306(1)025(2)(3)(4)(5) | 7.6 | 6 | 0.750 | 0.450 | NA | 125 | 1 |
| 35 | 20 | 2C | TSM2C206(1)035(2)(3)(4)(5) | 7.0 | 6 | 1.000 | 0.600 | NA | 125 | 1 |
| 6.3 | 660 | 2D | TSM2D667(1)006(2)(3)(4)(5) | 41.6 | 8 | 0.250 | 0.075 | 0.050 | 125 | 1 |
| 10 | 440 | 2D | TSM2D447(1)010(2)(3)(4)(5) | 44.0 | 8 | 0.250 | 0.100 | 0.040 | 125 | 1 |
| 16 | 300 | 2D | TSM2D307(1)016(2)(3)(4)(5) | 48.0 | 8 | 0.350 | 0.200 | 0.075 | 125 | 1 |
| 20 | 130 | 2D | TSM2D137(1)020(2)(3)(4)(5) | 27.2 | 8 | 0.350 | 0.100 | 0.075 | 125 | 1 |
| 25 | 94 | 2D | TSM2D946(1)025(2)(3)(4)(5) | 23.6 | 10 | 0.350 | 0.100 | 0.060 | 125 | 1 |
| 35 | 44 | 2D | TSM2D446(1)035(2)(3)(4)(5) | 15.4 | 6 | 0.350 | 0.200 | 0.100 | 125 | 1 |
| 50 | 9.4 | 2D | TSM2D945(1)050(2)(3)(4)(5) | 4.8 | 6 | 0.750 | 0.300 | 0.140 | 125 | 1 |
| 10 | 660 | 2X | TSM2X667(1)010(2)(3)(4)(5) | 66.0 | 10 | 0.250 | 0.050 | 0.025 | 125 | 1 |
| 50 | 20 | 2X | TSM2X206(1)050(2)(3)(4)(5) | 10.0 | 6 | 0.350 | 0.200 | NA | 125 | 1 |

Table 1B – TSM3 Ratings & Part Number Reference

| Rated Voltage | Rated Capacitance | Case Code/ Case Size | KEMET Part Number | DC Leakage | DF | Standard ESR | Low ESR | Ultra-low ESR | Maximum Operating Temp | MSL |
|---------------|-------------------|-------------------------|------------------------------|-----------------------------------|---------------------------|---------------------------|---------------------------|---------------------------|------------------------|---------------------|
| VDC @ 85°C | µF | KEMET/EIA | (See below for part options) | µA at +25°C Maximum/ 5 Minutes | % at +25°C 120 Hz Maximum | Ω at 25°C 100 kHz Maximum | Ω at 25°C 100 kHz Maximum | Ω at 25°C 100 kHz Maximum | °C | Reflow Temp ≤ 260°C |
| 6.3 | 660 | 3C | TSM3C667(1)006(2)(3)(4)(5) | 41.7 | 10 | 0.400 | 0.100 | 0.077 | 125 | 1 |
| 10 | 300 | 3C | TSM3C307(1)010(2)(3)(4)(5) | 30.0 | 8 | 0.400 | 0.100 | NA | 125 | 1 |
| 16 | 140 | 3C | TSM3C147(1)016(2)(3)(4)(5) | 22.5 | 6 | 0.400 | 0.167 | 0.117 | 125 | 1 |
| 20 | 66 | 3C | TSM3C666(1)020(2)(3)(4)(5) | 13.2 | 6 | 0.400 | 0.133 | NA | 125 | 1 |
| 25 | 45 | 3C | TSM3C456(1)025(2)(3)(4)(5) | 11.4 | 6 | 0.500 | 0.300 | NA | 125 | 1 |
| 35 | 30 | 3C | TSM3C306(1)035(2)(3)(4)(5) | 10.5 | 6 | 0.667 | 0.400 | NA | 125 | 1 |
| 6.3 | 990 | 3D | TSM3D997(1)006(2)(3)(4)(5) | 62.4 | 8 | 0.167 | 0.050 | 0.033 | 125 | 1 |
| 10 | 660 | 3D | TSM3D667(1)010(2)(3)(4)(5) | 66.0 | 8 | 0.167 | 0.067 | 0.027 | 125 | 1 |
| 16 | 450 | 3D | TSM3D457(1)016(2)(3)(4)(5) | 72.0 | 8 | 0.233 | 0.133 | 0.050 | 125 | 1 |
| 20 | 200 | 3D | TSM3D207(1)020(2)(3)(4)(5) | 40.8 | 8 | 0.233 | 0.067 | 0.050 | 125 | 1 |
| 25 | 140 | 3D | TSM3D147(1)025(2)(3)(4)(5) | 35.4 | 10 | 0.233 | 0.067 | 0.040 | 125 | 1 |
| 35 | 66 | 3D | TSM3D666(1)035(2)(3)(4)(5) | 23.1 | 6 | 0.233 | 0.133 | 0.067 | 125 | 1 |
| 50 | 14 | 3D | TSM3D146(1)050(2)(3)(4)(5) | 7.2 | 6 | 0.500 | 0.200 | 0.093 | 125 | 1 |
| 10 | 990 | 3X | TSM3X997(1)010(2)(3)(4)(5) | 99.0 | 10 | 0.167 | 0.033 | 0.017 | 125 | 1 |
| 50 | 30 | 3X | TSM3X306(1)050(2)(3)(4)(5) | 15.0 | 6 | 0.233 | 0.133 | NA | 125 | 1 |

(1) To complete KEMET part number, insert M for ± 20%, K for ± 10%. Designates Capacitance tolerance.

(2) To complete KEMET part number, insert B (0.1%/1,000 hours), C (0.01%/1,000 hours) or A = N/A. Designates Reliability Level.

(3) To complete KEMET part number, insert B = Gold Plated, C = Hot solder dipped, H = Solder Plated, or T = 100% Tin (Sn). Designates Termination Finish.

(4) To complete KEMET part number, insert 61 = None, 62 = 10 cycles +25°C, 63 = 10 cycles -55°C +85°C after Weibull or 64 = 10 cycles -55°C +85°C before Weibull. Designates Surge current option.

(5) To complete KEMET part number, insert 10 = Standard ESR, 20 = Low ESR or 30 = Ultra Low ESR. Designates ESR option.
Refer to Ordering Information for additional detail.

Table 1C – TSM4 Ratings & Part Number Reference

| Rated Voltage | Rated Capacitance | Case Code/ Case Size | KEMET Part Number | DC Leakage | DF | Standard ESR | Low ESR | Ultra-low ESR | Maximum Operating Temp | MSL |
|---------------|-------------------|-------------------------|------------------------------|-----------------------------------|---------------------------|---------------------------|---------------------------|---------------------------|------------------------|---------------------|
| VDC @ 85°C | µF | KEMET/EIA | (See below for part options) | µA at +25°C Maximum/ 5 Minutes | % at +25°C 120 Hz Maximum | Ω at 25°C 100 kHz Maximum | Ω at 25°C 100 kHz Maximum | Ω at 25°C 100 kHz Maximum | °C | Reflow Temp ≤ 260°C |
| 6.3 | 880 | 4C | TSM4C887(1)006(2)(3)(4)(5) | 55.6 | 10 | 0.300 | 0.075 | 0.058 | 125 | 1 |
| 10 | 400 | 4C | TSM4C407(1)010(2)(3)(4)(5) | 40.0 | 8 | 0.300 | 0.075 | NA | 125 | 1 |
| 16 | 190 | 4C | TSM4C197(1)016(2)(3)(4)(5) | 30.0 | 6 | 0.300 | 0.125 | 0.088 | 125 | 1 |
| 20 | 88 | 4C | TSM4C886(1)020(2)(3)(4)(5) | 17.6 | 6 | 0.300 | 0.100 | NA | 125 | 1 |
| 25 | 60 | 4C | TSM4C606(1)025(2)(3)(4)(5) | 15.2 | 6 | 0.375 | 0.225 | NA | 125 | 1 |
| 35 | 40 | 4C | TSM4C406(1)035(2)(3)(4)(5) | 14.0 | 6 | 0.500 | 0.300 | NA | 125 | 1 |
| 6.3 | 1300 | 4D | TSM4D138(1)006(2)(3)(4)(5) | 83.2 | 8 | 0.125 | 0.038 | 0.025 | 125 | 1 |
| 10 | 880 | 4D | TSM4D887(1)010(2)(3)(4)(5) | 88.0 | 8 | 0.125 | 0.050 | 0.020 | 125 | 1 |
| 16 | 600 | 4D | TSM4D607(1)016(2)(3)(4)(5) | 96.0 | 8 | 0.175 | 0.100 | 0.038 | 125 | 1 |
| 20 | 270 | 4D | TSM4D277(1)020(2)(3)(4)(5) | 54.4 | 8 | 0.175 | 0.050 | 0.038 | 125 | 1 |
| 25 | 180 | 4D | TSM4D187(1)025(2)(3)(4)(5) | 47.2 | 10 | 0.175 | 0.050 | 0.030 | 125 | 1 |
| 35 | 88 | 4D | TSM4D886(1)035(2)(3)(4)(5) | 30.8 | 6 | 0.175 | 0.100 | 0.050 | 125 | 1 |
| 50 | 19 | 4D | TSM4D196(1)050(2)(3)(4)(5) | 9.6 | 6 | 0.375 | 0.150 | 0.070 | 125 | 1 |
| 10 | 1300 | 4X | TSM4X138(1)010(2)(3)(4)(5) | 132.0 | 10 | 0.125 | 0.025 | 0.013 | 125 | 1 |
| 50 | 40 | 4X | TSM4X406(1)050(2)(3)(4)(5) | 20.0 | 6 | 0.175 | 0.100 | NA | 125 | 1 |

Table 1D – TSM6 Ratings & Part Number Reference

| Rated Voltage | Rated Capacitance | Case Code/ Case Size | KEMET Part Number | DC Leakage | DF | Standard ESR | Low ESR | Ultra-low ESR | Maximum Operating Temp | MSL |
|---------------|-------------------|-------------------------|------------------------------|-----------------------------------|---------------------------|---------------------------|---------------------------|---------------------------|------------------------|---------------------|
| VDC @ 85°C | µF | KEMET/EIA | (See below for part options) | µA at +25°C Maximum/ 5 Minutes | % at +25°C 120 Hz Maximum | Ω at 25°C 100 kHz Maximum | Ω at 25°C 100 kHz Maximum | Ω at 25°C 100 kHz Maximum | °C | Reflow Temp ≤ 260°C |
| 6.3 | 1300 | 6C | TSM6C138(1)006(2)(3)(4)(5) | 83.4 | 10 | 0.200 | 0.050 | 0.038 | 125 | 1 |
| 10 | 600 | 6C | TSM6C607(1)010(2)(3)(4)(5) | 60.0 | 8 | 0.200 | 0.050 | NA | 125 | 1 |
| 16 | 280 | 6C | TSM6C287(1)016(2)(3)(4)(5) | 45.0 | 6 | 0.200 | 0.083 | 0.058 | 125 | 1 |
| 20 | 130 | 6C | TSM6C137(1)020(2)(3)(4)(5) | 26.4 | 6 | 0.200 | 0.067 | NA | 125 | 1 |
| 25 | 90 | 6C | TSM6C906(1)025(2)(3)(4)(5) | 22.8 | 6 | 0.250 | 0.150 | NA | 125 | 1 |
| 35 | 60 | 6C | TSM6C606(1)035(2)(3)(4)(5) | 21.0 | 6 | 0.333 | 0.200 | NA | 125 | 1 |
| 6.3 | 2000 | 6D | TSM6D208(1)006(2)(3)(4)(5) | 124.8 | 8 | 0.083 | 0.025 | 0.017 | 125 | 1 |
| 10 | 1300 | 6D | TSM6D138(1)010(2)(3)(4)(5) | 132.0 | 8 | 0.083 | 0.033 | 0.013 | 125 | 1 |
| 16 | 900 | 6D | TSM6D907(1)016(2)(3)(4)(5) | 144.0 | 8 | 0.117 | 0.067 | 0.025 | 125 | 1 |
| 20 | 410 | 6D | TSM6D417(1)020(2)(3)(4)(5) | 81.6 | 8 | 0.117 | 0.033 | 0.025 | 125 | 1 |
| 25 | 280 | 6D | TSM6D287(1)025(2)(3)(4)(5) | 70.8 | 10 | 0.117 | 0.033 | 0.020 | 125 | 1 |
| 35 | 130 | 6D | TSM6D137(1)035(2)(3)(4)(5) | 46.2 | 6 | 0.117 | 0.067 | 0.033 | 125 | 1 |
| 50 | 28 | 6D | TSM6D286(1)050(2)(3)(4)(5) | 14.4 | 6 | 0.250 | 0.100 | 0.047 | 125 | 1 |
| 10 | 2000 | 6X | TSM6X208(1)010(2)(3)(4)(5) | 198.0 | 10 | 0.083 | 0.017 | 0.008 | 125 | 1 |
| 50 | 60 | 6X | TSM6X606(1)050(2)(3)(4)(5) | 30.0 | 6 | 0.117 | 0.067 | NA | 125 | 1 |

- 1) To complete KEMET part number, insert M for ± 20%, K for ± 10%. Designates Capacitance tolerance.
 - 2) To complete KEMET part number, insert B (0.1%/1,000 hours), C (0.01%/1,000 hours) or A = N/A. Designates Reliability Level.
 - 3) To complete KEMET part number, insert B = Gold Plated, C = Hot solder dipped, H = Solder Plated, or T = 100% Tin (Sn). Designates Termination Finish.
 - 4) To complete KEMET part number, insert 61 = None, 62 = 10 cycles +25°C, 63 = 10 cycles -55°C +85°C after Weibull or 64 = 10 cycles -55°C +85°C before Weibull. Designates Surge current option.
 - 5) To complete KEMET part number, insert 10 = Standard ESR, 20 = Low ESR or 30 = Ultra Low ESR. Designates ESR option.
- Refer to Ordering Information for additional detail.

Recommended Voltage Derating Guidelines



Reverse Voltage

Solid tantalum capacitors are polar devices and may be permanently damaged or destroyed if connected with the wrong polarity. The positive terminal is identified on the capacitor body by a stripe plus in some cases a beveled edge. A small degree of transient reverse voltage is permissible for short periods per the table. The capacitors should not be operated continuously in reverse mode, even within these limits.

| Temperature | Permissible Transient Reverse Voltage |
|-------------|---------------------------------------|
| 25°C | 15% of Rated Voltage |
| 85°C | 5% of Rated Voltage |
| 125°C | 1% of Rated Voltage |

Table 2 – Land Dimensions/Courtyard

| KEMET | Density Level A: Maximum (Most) Land Protrusion (mm) | | | | | Density Level B: Median (Nominal) Land Protrusion (mm) | | | | | Density Level C: Minimum (Least) Land Protrusion (mm) | | | | |
|-------|--|------|------|-------|-------|--|------|------|------|------|---|------|------|------|------|
| | Case | L | W | S | V1 | V2 | L | W | S | V1 | V2 | L | W | S | V1 |
| TSM2C | 2.98 | 2.74 | 2.53 | 9.50 | 4.50 | 2.58 | 2.62 | 2.73 | 8.40 | 4.00 | 2.20 | 2.52 | 2.89 | 7.54 | 3.74 |
| TSM2D | 3.48 | 3.24 | 3.03 | 11.00 | 5.60 | 3.08 | 3.12 | 3.23 | 9.90 | 5.10 | 2.70 | 3.02 | 3.39 | 9.04 | 4.84 |
| TSM2X | 3.48 | 3.24 | 3.03 | 11.00 | 5.60 | 3.08 | 3.12 | 3.23 | 9.90 | 5.10 | 2.70 | 3.02 | 3.39 | 9.04 | 4.84 |
| TSM3C | 2.98 | 2.74 | 2.53 | 9.50 | 4.50 | 2.58 | 2.62 | 2.73 | 8.40 | 4.00 | 2.20 | 2.52 | 2.89 | 7.54 | 3.74 |
| TSM3D | 3.48 | 3.24 | 3.03 | 11.00 | 5.60 | 3.08 | 3.12 | 3.23 | 9.90 | 5.10 | 2.70 | 3.02 | 3.39 | 9.04 | 4.84 |
| TSM3X | 3.48 | 3.24 | 3.03 | 11.00 | 5.60 | 3.08 | 3.12 | 3.23 | 9.90 | 5.10 | 2.70 | 3.02 | 3.39 | 9.04 | 4.84 |
| TSM4C | 2.98 | 6.04 | 2.53 | 9.50 | 7.80 | 2.58 | 5.92 | 2.73 | 8.40 | 7.30 | 2.20 | 5.82 | 2.89 | 7.54 | 7.04 |
| TSM4D | 3.48 | 7.64 | 3.03 | 11.00 | 10.10 | 3.08 | 7.52 | 3.23 | 9.90 | 9.60 | 2.70 | 7.42 | 3.39 | 9.04 | 9.34 |
| TSM4X | 3.48 | 7.64 | 3.03 | 11.00 | 10.10 | 3.08 | 7.52 | 3.23 | 9.90 | 9.60 | 2.70 | 7.42 | 3.39 | 9.04 | 9.34 |
| TSM6C | 2.98 | 6.04 | 2.53 | 9.50 | 7.80 | 2.58 | 5.92 | 2.73 | 8.40 | 7.30 | 2.20 | 5.82 | 2.89 | 7.54 | 7.04 |
| TSM6D | 3.48 | 7.64 | 3.03 | 11.00 | 10.10 | 3.08 | 7.52 | 3.23 | 9.90 | 9.60 | 2.70 | 7.42 | 3.39 | 9.04 | 9.34 |
| TSM6X | 3.48 | 7.64 | 3.03 | 11.00 | 10.10 | 3.08 | 7.52 | 3.23 | 9.90 | 9.60 | 2.70 | 7.42 | 3.39 | 9.04 | 9.34 |

Density Level A: For low-density Product applications. Recommended for wave solder applications and provides a wider process window for reflow solder processes.

Density Level B: For products with a moderate level of component density. Provides a robust solder attachment condition for reflow solder processes.

Density Level C: For high component density product applications. Before adapting the minimum land pattern variations the user should perform qualification testing based on the conditions outlined in IPC standard 7351 (IPC-7351).

¹ Height of these chips may create problems in wave soldering.

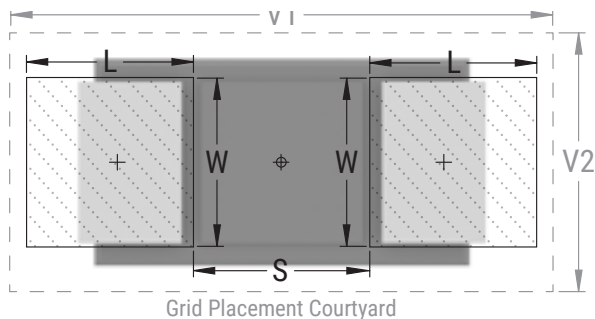

Soldering Process

KEMET’s families of surface mount capacitors are compatible with wave (single or dual), convection, IR, or vapor phase reflow techniques. Preheating of these components is recommended to avoid extreme thermal stress. KEMET’s recommended profile conditions for convection and IR reflow reflect the profile conditions of the IPC/J–STD–020D standard for moisture sensitivity testing. The devices can safely withstand a maximum of three reflow passes at these conditions.

Please note that although the X/7343–43 case size can withstand wave soldering, the tall profile (4.3 mm maximum) dictates care in wave process development.

Hand soldering should be performed with care due to the difficulty in process control. If performed, care should be taken to avoid contact of the soldering iron to the molded case. The iron should be used to heat the solder pad, applying solder between the pad and the termination, until reflow occurs. Once reflow occurs, the iron should be removed immediately. “Wiping” the edges of a chip and heating the top surface is not recommended.

During typical reflow operations, a slight darkening of the gold-colored epoxy may be observed. This slight darkening is normal and not harmful to the product. Marking permanency is not affected by this change.

| Profile Feature | SnPb Assembly | Pb-Free Assembly |
|---|---------------------|---------------------|
| Preheat/Soak | | |
| Temperature Minimum (T_{smin}) | 100°C | 150°C |
| Temperature Maximum (T_{smax}) | 150°C | 200°C |
| Time (t_s) from T_{smin} to T_{smax} | 60 – 120 seconds | 60 – 120 seconds |
| Ramp-up Rate (T_L to T_p) | 3°C/seconds maximum | 3°C/seconds maximum |
| Liquidous Temperature (T_L) | 183°C | 217°C |
| Time Above Liquidous (t_L) | 60 – 150 seconds | 60 – 150 seconds |
| Peak Temperature (T_p) | 220°C* | 250°C* |
| Time within 5°C of Maximum Peak Temperature (t_p) | 20 seconds maximum | 30 seconds maximum |
| Ramp-down Rate (T_p to T_L) | 6°C/seconds maximum | 6°C/seconds maximum |
| Time 25°C to Peak Temperature | 6 minutes maximum | 8 minutes maximum |

Note: All temperatures refer to the center of the package, measured on the package body surface that is facing up during assembly reflow.

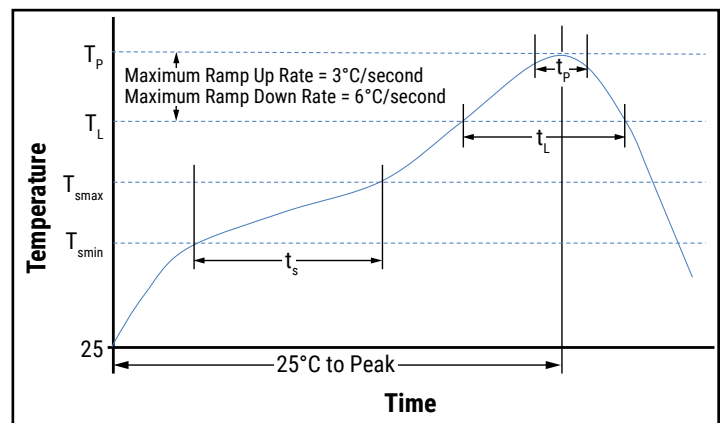

Storage

Tantalum chip capacitors should be stored in normal working environments. While the chips themselves are quite robust in other environments, solderability will be degraded by exposure to high temperatures, high humidity, corrosive atmospheres, and long term storage. In addition, packaging materials will be degraded by high temperature – reels may soften or warp and tape peel force may increase. KEMET recommends that maximum storage temperature not exceed 40°C and maximum storage humidity not exceed 60% relative humidity. Temperature fluctuations should be minimized to avoid condensation on the parts and atmospheres should be free of chlorine and sulphur bearing compounds. For optimized solderability chip stock should be used promptly, preferably within three years of receipt.

Construction

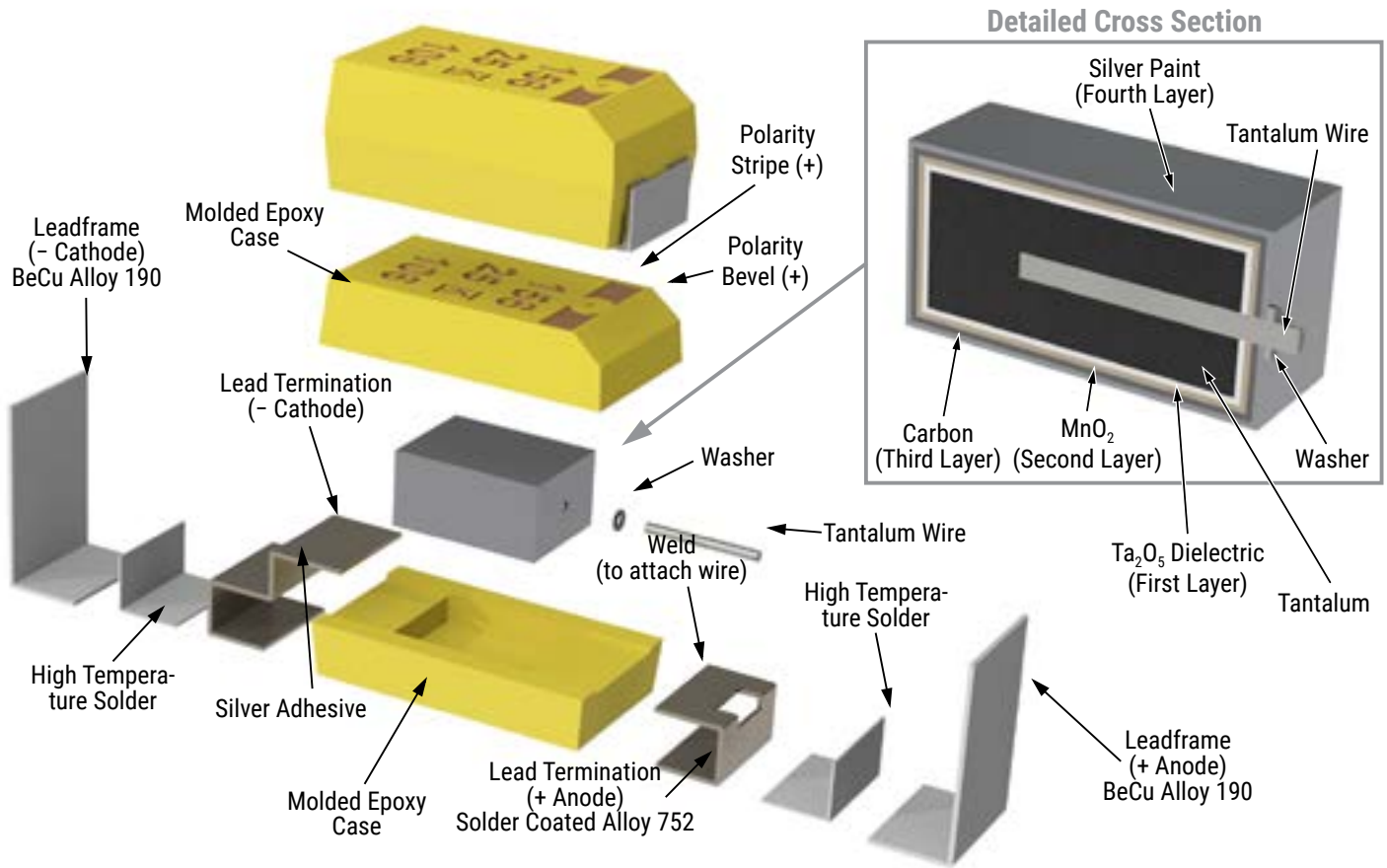

Marking (Discrete Capacitor)

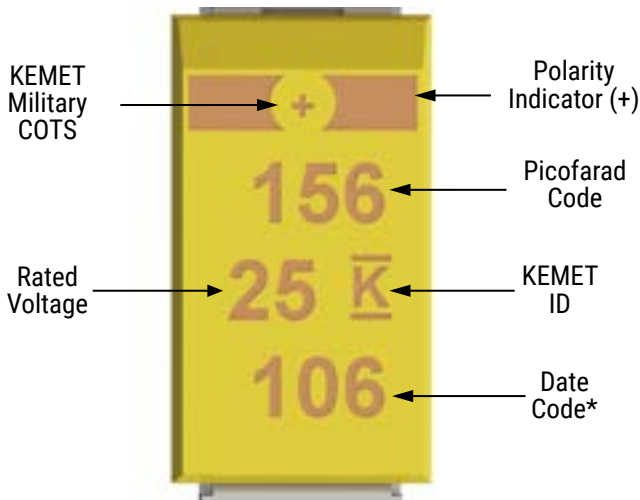

* 106 = 6th week of 2021

| Date Code * | |
|--|--|
| 1 st digit = Last number of Year | 7 = 2017 8 = 2018 9 = 2019 0 = 2020 1 = 2021 |
| 2 nd and 3 rd digit = Week of the Year | 01 = 1 st week of the Year to 52 = 52 nd week of the Year |

NOTE: The marking observed is for the discrete capacitor used in the construction of the stacked product.

KEMET Electronics Corporation Sales Offices

For a complete list of our global sales offices, please visit www.kemet.com/sales.

Disclaimer

All product specifications, statements, information and data (collectively, the "Information") in this datasheet are subject to change. The customer is responsible for checking and verifying the extent to which the Information contained in this publication is applicable to an order at the time the order is placed. All Information given herein is believed to be accurate and reliable, but it is presented without guarantee, warranty, or responsibility of any kind, expressed or implied.

Statements of suitability for certain applications are based on KEMET Electronics Corporation's ("KEMET") knowledge of typical operating conditions for such applications, but are not intended to constitute – and KEMET specifically disclaims – any warranty concerning suitability for a specific customer application or use. The Information is intended for use only by customers who have the requisite experience and capability to determine the correct products for their application. Any technical advice inferred from this Information or otherwise provided by KEMET with reference to the use of KEMET's products is given gratis, and KEMET assumes no obligation or liability for the advice given or results obtained.

Although KEMET designs and manufactures its products to the most stringent quality and safety standards, given the current state of the art, isolated component failures may still occur. Accordingly, customer applications which require a high degree of reliability or safety should employ suitable designs or other safeguards (such as installation of protective circuitry or redundancies) in order to ensure that the failure of an electrical component does not result in a risk of personal injury or property damage.

Although all product-related warnings, cautions and notes must be observed, the customer should not assume that all safety measures are indicated or that other measures may not be required.

KEMET is a registered trademark of KEMET Electronics Corporation.

X-ON Electronics

Largest Supplier of Electrical and Electronic Components

Click to view similar products for [Tantalum Capacitors - Solid SMD category:](#)

Click to view products by [Kemet manufacturer:](#)

Other Similar products are found below :

[CWR06HC106KB](#) [CWR09MC155KR-TR25](#) [CWR09NC335KC-TR25](#) [B45197-A2157-M509](#) [B45197A5226M409](#) [NTC-T476K10TRDF](#)
[CWR06KC106KP](#) [CWR09KB106KCA](#) [TCSCS1A336KBAR](#) [TCTP0J336M8R](#) [B45196-H5106-K309](#) [B45196-H6226-K509](#)
[CWR09JC225JBB](#) [T83D475K050RCCL](#) [T83E107K016RCCL](#) [T83D685K035RCCL](#) [CWR11HH105KB](#) [293D155X9020A2DE3](#)
[CWR29KC156KDHC\100](#) [CWR09NC224KB](#) [CWR29FC685KCEC](#) [CWR09NC684KM](#) [CWR29HH155KCBB](#) [CWR29HC106KCDC](#)
[CWR29FC336KDGC](#) [CWR09NC225KDB](#) [CWR29FC475KDDC](#) [CWR29HC225KCAC](#) [CWR11KC106KBB](#) [CWR09JH105KC](#)
[293D476X9035E2TE3](#) [CWR29JC335KDDC](#) [CWR29KC226JCGC](#) [CWR29FC105KDAC](#) [CWR29DC337KCHC](#) [NTC-T686K6.3TRBF](#)
[595D686X9010B2T](#) [594D686X9016C2T](#) [595D106X0025C8T](#) [TAZH685K035LBSB0824](#) [TAZG107K010LBSB0800](#)
[TAZH475K050LBSB0H23](#) [TAJD107K016KNJ](#) [TAZH227K010LBSB0024](#) [TAZH156K025CBSZ0824](#) [TAZH227J010LBSZ0800](#)
[TPSE687M006H0045](#) [TBJD156K025CBSZ0824](#) [TMCSA1V154MTRF](#) [TMCSA0G335MTRF](#)