

THIS DOCUMENT IS THE PROPERTY OF KEYSTONE ELECTRONICS CORP. AND SHALL NOT BE REPRODUCED, DISTRIBUTED OR USED AS A BASIS FOR MANUFACTURE WITHOUT PRIOR WRITTEN PERMISSION FROM KEYSTONE ELECTRONICS CORP.

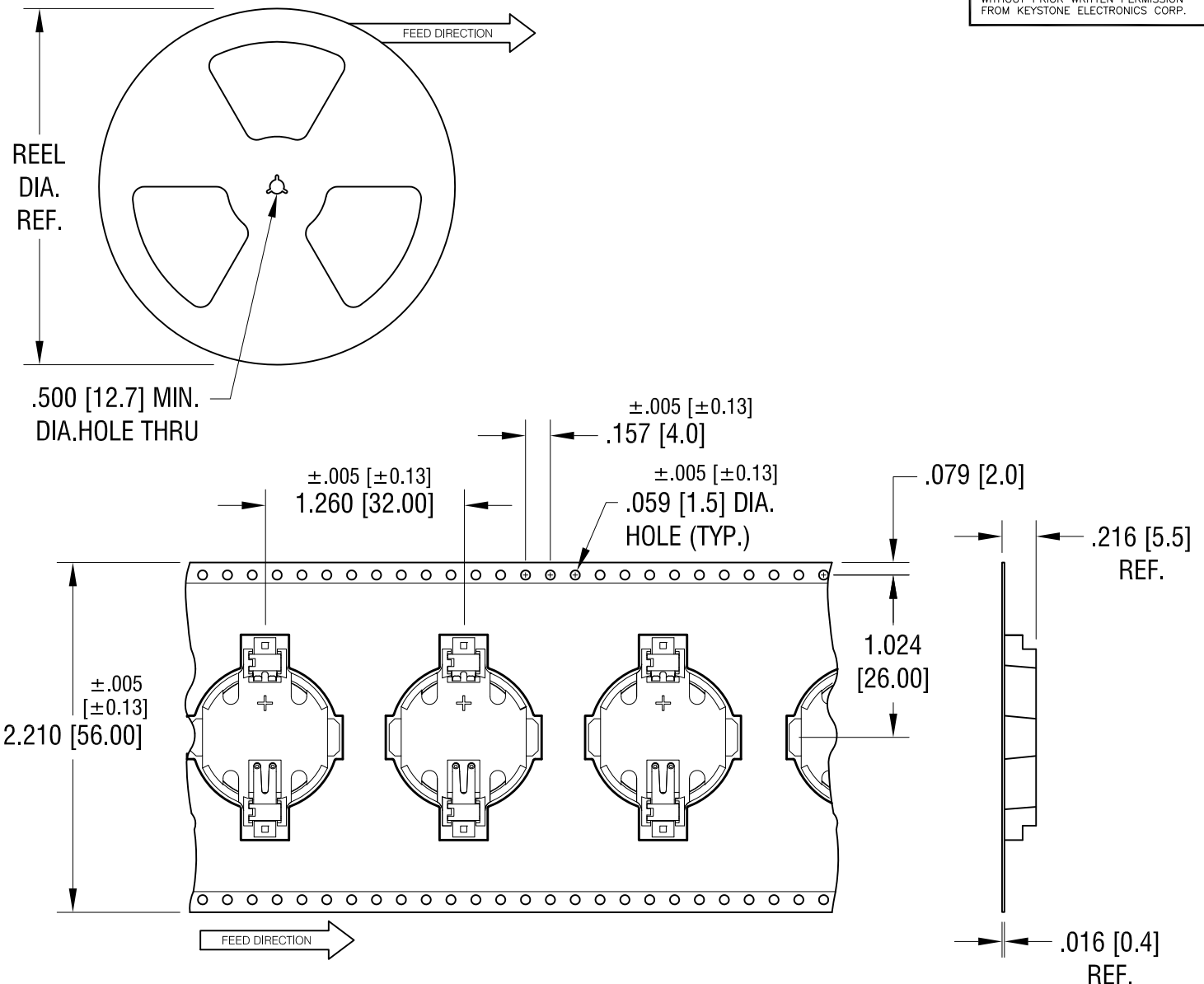

NOTES:

TAPE AND REEL SPECIFICATIONS:

1. TAPE:

MAT'L - ALL CONDUCTIVE POLYSTYRENE CARRIER
 ANSI/EIA-481 STANDARD
 2.21 [56.0] WIDE; 1.26 [32] PITCH

2. REEL:

13.0 [330.2] DIA. 400 PIECES OF
 PART NO. 1057 (REV. H) PER REEL.

11.06.14	CHANGE AS PER ECN14-115	B
6.10.13	TAPE WIDTH WAS 44mm CHANGE AS PER ECN 13-045	A
DATE	DESCRIPTION	REV.

KEYSTONE ELECTRONICS CORP.			
www.keyelco.com • ASTORIA, N.Y. 11105-2017 • Tel (718) 956-8900			
PART NAME 2032mm SM COIN CELL HOLDER ON TAPE			
MATERIAL AS NOTED			
FINISH AS NOTED		DRN BY NT	DATE 5.28.13
		APP'D	SCALE 1X
TOLERANCES DECIMAL ANGULAR ± 1° UNLESS OTHERWISE SPECIFIED	INCH [MM] ± .015 [± 0.38]	CODE C	DWG NO. 1057TR

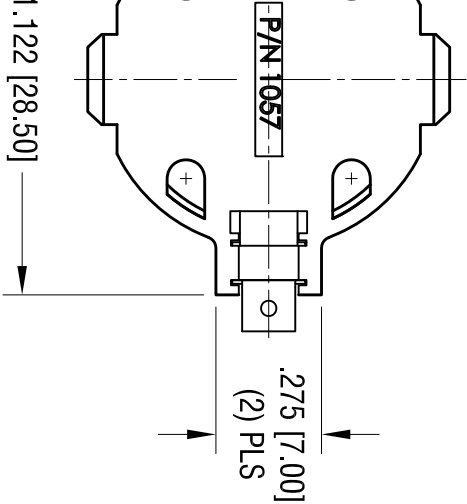
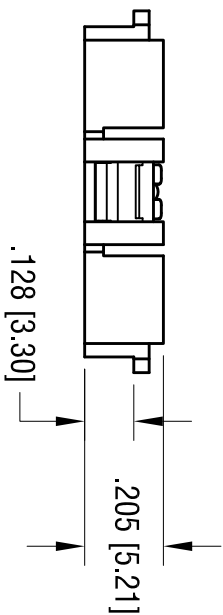
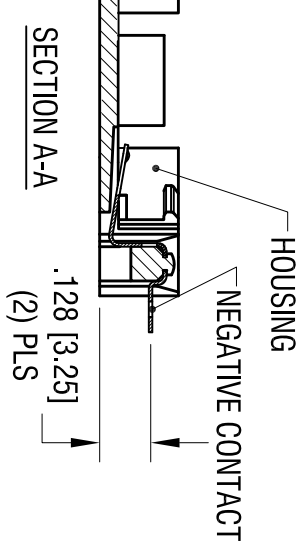
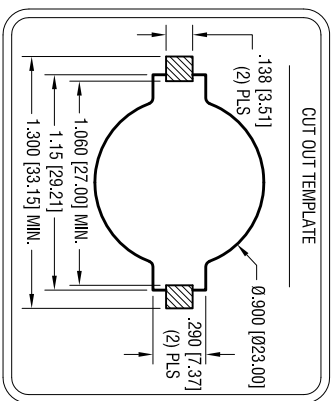
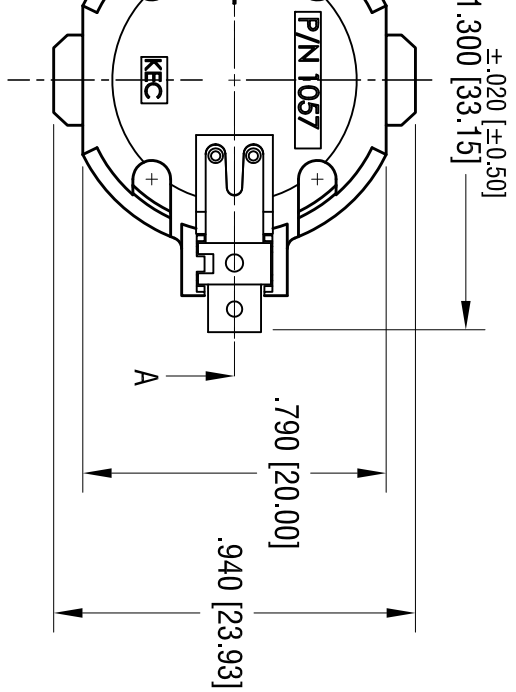

DATE	DESCRIPTION	REV.
6.04.13	CHANGE AS PER ECN 13-043	A
7.19.13	CHANGE AS PER ECN 13-058	B
7.24.13	CHANGE AS PER ECN 13-060	C
9.17.13	CHANGE AS PER ECN 13-072	D
10.24.13	CHANGE AS PER ECN 13-103	E
1.30.14	CHANGE AS PER ECN 14-014	F
3.10.14	CHANGE AS PER ECN 14-025	G
10.23.14	CHANGE AS PER ECN 14-110	H

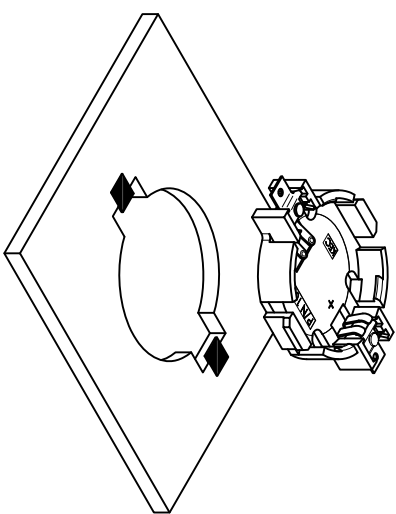

ACTUAL SIZE

NOTES:

1. BASE:
MAT'L - GLASS FILLED LCP UL 94V-0, NATURAL
2. CONTACTS:
MAT'L - .009 [0.23] THK PHOSPHOR BRONZE
FINISH: GOLD FLASH, OVER NICKEL PLATING

KEYSTONE ELECTRONICS CORP.

www.keystoneelectronics.com • ASTORIA, N.Y. 11105-2017 • Tel (718) 956-8900

PART NAME

2032 BATTERY HOLDER, SMT

MATERIAL

AS NOTED

FINISH

AS NOTED

TOLERANCES	INCH	[MM]	CODE
DECIMAL	± .010	[± 0.25]	C
ANGULAR	± 1°		

DRN BY

NT

DATE

5.28.13

App'd

SCALE

2X

DWG NO.

1057

THIS DOCUMENT IS THE PROPERTY OF KEYSTONE ELECTRONICS CORP. AND SHALL NOT BE REPRODUCED, DISTRIBUTED OR USED AS A BASIS FOR MANUFACTURE WITHOUT PRIOR WRITTEN PERMISSION FROM KEYSTONE ELECTRONICS CORP.

X-ON Electronics

Largest Supplier of Electrical and Electronic Components

Click to view similar products for [Coin Cell Battery Holders](#) category:

Click to view products by [Keystone](#) manufacturer:

Other Similar products are found below :

[SMTU2450N-LF](#) [PDSN-11-D](#) [1058](#) [1052](#) [799-2007](#) [BH44AAB](#) [BH48DL](#) [BH8000](#) [BS-6-1](#) [79573231](#) [101](#) [3035](#) [1025](#) [1026](#) [1027](#) [103](#)
[1059](#) [1060](#) [1063](#) [1065](#) [D3](#) [46400000](#) [BC-0403](#) [BH-121-1B](#) [BH-1/2AA-2A](#) [BH-131A](#) [BH-3101A](#) [BH-3103B](#) [BH-311-1A](#) [BH-311-1D](#) [BH-](#)
[321-1A](#) [BH-321-1B](#) [BH-321-1D](#) [BH-331-3D](#) [BH-331P](#) [BH-333A](#) [BH-341-1P](#) [BH-351A](#) [BH-362B](#) [BH-421A](#) [BH-422A](#) [BH-425A](#) [BH-](#)
[431-1B](#) [BH-463A](#) [BH-511A](#) [BHC-18650-1P](#) [46300000](#) [46600000](#) [799-2001](#) [SBH-331A](#)