

THIS DOCUMENT IS THE PROPERTY OF KEYSTONE ELECTRONICS CORP. AND SHALL NOT BE REPRODUCED, DISTRIBUTED OR USED AS A BASIS FOR MANUFACTURE WITHOUT PRIOR WRITTEN PERMISSION FROM KEYSTONE ELECTRONICS CORP.

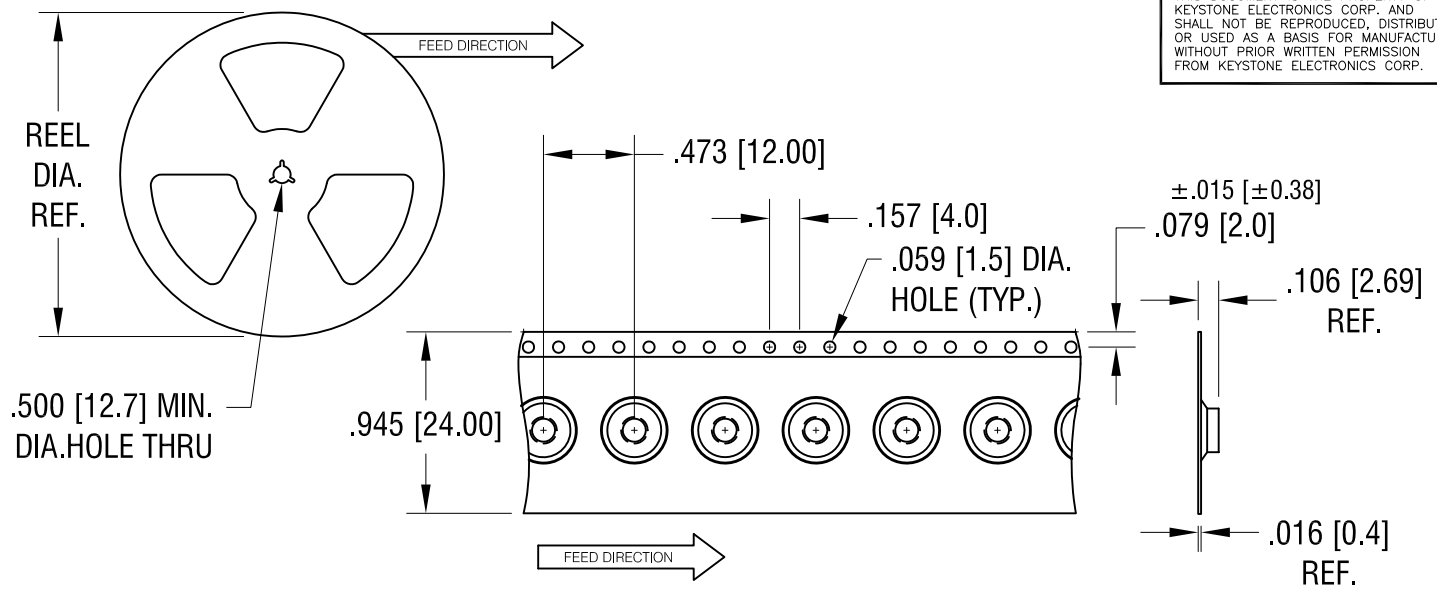

MOUNTING DETAIL

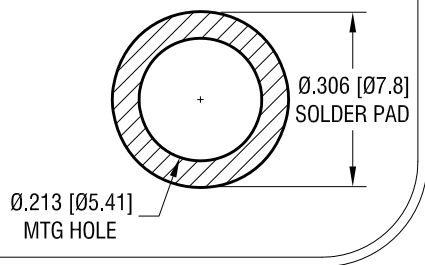

ACTUAL SIZE

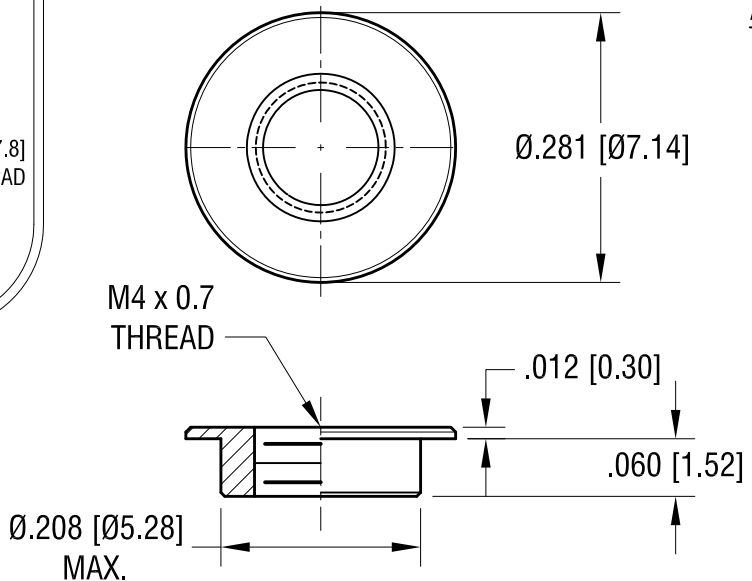

NOTES:

1. SUPPLIED ON TAPE AND REEL ONLY.
TAPE AND REEL SPECIFICATIONS:
2. TAPE:
MAT'L - ALL CONDUCTIVE POLYSTYRENE CARRIER
ANSI/EIA-481 STANDARD
3. REEL:
13" [330.2] DIA. 1500 PIECES PER REEL
4. KAPTON TAPE ADDED TO TOP SURFACE OF STANDOFF

KEYSTONE ELECTRONICS CORP.			
www.keyelco.com • NEW HYDE PARK, NY 11040 • Tel (516) 328-7500			
PART NAME			
"ZERO" HEIGHT HOLE THREADER			
MATERIAL			
STEEL			
FINISH		DRN BY	DATE
ELECTRO-TIN		NT	1.11.22
		APP'D	SCALE
			5X, 1X
TOLERANCES	INCH [MM]	CODE	DWG NO.
DECIMAL	± .005 [± 0.13]	C	24949
ANGULAR	± 1°		
UNLESS OTHERWISE SPECIFIED			

DATE	DESCRIPTION	REV.

X-ON Electronics

Largest Supplier of Electrical and Electronic Components

Click to view similar products for [Washers](#) category:

Click to view products by [Keystone](#) manufacturer:

Other Similar products are found below :

[690124-7](#) [751-00001](#) [1-22145-3](#) [1393160-3](#) [200503-1](#) [2079764-1](#) [26-0048](#) [9-1616357-4](#) [S3997](#) [300083](#) [18025-1](#) [18025-2](#) [18027-3](#)
[2101245-4](#) [21055-6](#) [21075-6](#) [21899-4](#) [22480-5](#) [373069](#) [373482](#) [IP0360](#) [551333-1](#) [1302260547](#) [690124-3](#) [21024-8](#) [300993](#) [8-1616359-4](#)
[75163](#) [5743-N-216-050-116](#) [8560-0158-80](#) [M0404-SS](#) [16FW312032B](#) [12SWS3200](#) [17W10007](#) [17W06875B](#) [m3452-ss](#) [5757-PH-688-070-](#)
[562](#) [75143](#) [5704-N-220-050-141](#) [5589-PH-140-029-120](#) [AT14-001-2486](#) [1302344700](#) [1476](#) [1477](#) [114021-ZZ](#) [SW-032-135](#) [7230-1](#) [PW1](#)
[2246](#) [2248](#)