

THIS DOCUMENT IS THE PROPERTY OF
KEYSTONE ELECTRONICS CORP. AND
SHALL NOT BE REPRODUCED, DISTRIBUTED
OR USED AS A BASIS FOR MANUFACTURE
WITHOUT PRIOR WRITTEN PERMISSION
FROM KEYSTONE ELECTRONICS CORP.

ACTUAL SIZE

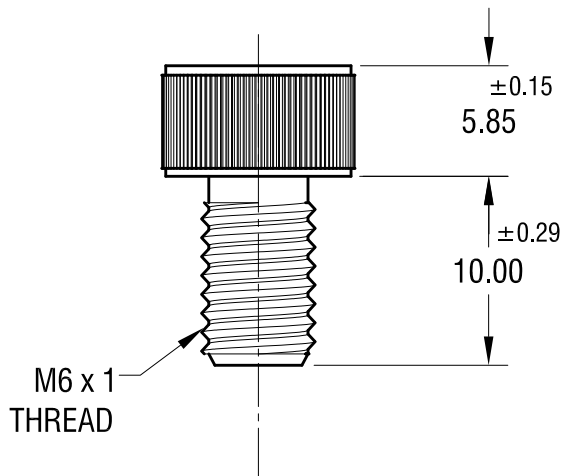
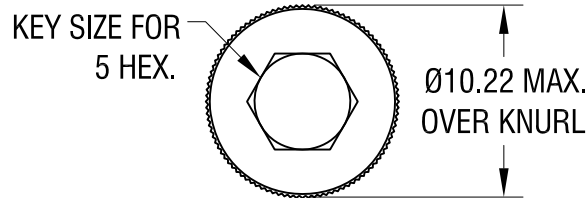

NOTE:

1. ALL DIMENSIONS ARE IN MILLIMETERS

KEYSTONE ELECTRONICS CORP.			
www.keyelco.com • NEW HYDE PARK, NY 11040 • Tel (516) 328-7500			
PART NAME		SOCKET HEAD SCREW	
MATERIAL		TITANIUM, GRADE 2	
FINISH		DRN BY	DATE
NONE		NT	10.31.19
		APP'D	SCALE
			2.5X
TOLERANCES	INCH	[MM]	CODE
DECIMAL	±	[± 0.13]	C
ANGULAR	± 1°		
UNLESS OTHERWISE SPECIFIED			DWG NO.
			25061

DATE	DESCRIPTION	REV.

X-ON Electronics

Largest Supplier of Electrical and Electronic Components

Click to view similar products for [Screws & Fasteners](#) category:

Click to view products by [Keystone](#) manufacturer:

Other Similar products are found below :

[5721-1440-1/4-SS](#) [593503FX](#) [0098.0094](#) [0098.9206](#) [0098.9219](#) [0098.9262](#) [596-2114-013](#) [59781-6](#) [0098.0026](#) [0098.9210](#) [0098.9212](#) [60227-01](#) [60227-04](#) [60227-08](#) [60687-01](#) [LOCK WASHER Black](#) [62153-03](#) [62153-11](#) [M316-KSSTMCZ100](#) [M3440-SS](#) [M3442-SS](#) [M3448-SS](#) [6292-1](#) [6-306105-9](#) [6-306131-4](#) [690432-1](#) [699161-000](#) [7230-3](#) [7244](#) [7248-1](#) [7248-2](#) [745564-1](#) [F1209](#) [751-00001](#) [7680](#) [809704-1](#) [8700](#) [8860220](#) [9047](#) [9521](#) [992326-6](#) [992763-3](#) [1-18024-0](#) [1-18028-2](#) [A168P1](#) [A495P1](#) [1-24921-1](#) [125416-1](#) [1260](#) [13-0036](#) [1301810148](#)